



SPECIFICATION FOR APPROVAL

Customer _____

Description DC FAN

Part No. _____ REV. _____

Delta Model No. AFC0912D-AF00 REV. 00

Sample Issue No. _____

Sample Issue Date SEP.07.2007

PLEASE SEND ONE COPY OF THIS SPECIFICATION
BACK AFTER YOU SIGNED APPROVAL FOR
PRODUCTION PRE-ARRANGMENT.

APPROVED BY: _____

DATE : _____

DELTA ELECTRONICS, INC.
TAOYUAN PLANT
252, SHANG YING ROAD, KUEI SAN INDUSTRIAL ZONE
TAOYUAN SHIEN, TAIWAN, R.O.C.
TEL:886-(0)3-3591968
FAX:886-(0)3-3591991

DELTA ELECTRONICS, INC.
 252, SHANG YING ROAD, KUEI SAN
 TAOYUAN HSIEN 333, TAIWAN, R. O. C.

TEL : 886-(0)3-3591968
 FAX : 886-(0)3-3591991

SPECIFICATION FOR APPROVAL

Customer:

Description: DC FAN

Customer P/N: REV:

Delta Model NO.: AFC0912D-AF00

Sample Rev: 00 Issue NO:

Sample Issue Date: SEP.07.2007 Quantity:

1. SCOPE:

THIS SPECIFICATION DEFINES THE ELECTRICAL AND MECHANICAL CHARACTERISTICS OF THE DC BRUSHLESS AXIAL FLOW FAN. THE FAN MOTOR IS WITH SINGLE PHASES AND FOUR POLES.

2. CHARACTERS:

ITEM	DESCRIPTION
RATED VOLTAGE	12.0 VDC
OPERATION VOLTAGE	8.0 - 13.2 VDC
INPUT CURRENT	0.75 (MAX. 1.00) A
INPUT POWER	9.00 (MAX. 10.80) W
SPEED (REF.)	4800 R.P.M.±10%
MAX. AIR FLOW (AT ZERO STATIC PRESSURE)	2.905 (MIN. 2.614) M ³ /MIN. 102.59 (MIN. 92.33) CFM
MAX. AIR PRESSURE (AT ZERO AIRFLOW)	13.35 (MIN.10.81) mmH ₂ O 0.526 (MIN. 0.426) inchH ₂ O
ACOUSTICAL NOISE (AVG.)	53.0 (MAX. 57.0) dB-A
INSULATION TYPE	UL: CLASS A

(continued)

PART NO:

DELTA MODEL: AFC0912D-AF00

INSULATION STRENGTH	10 MEG OHM MIN. AT 500 VDC (BETWEEN FRAME AND (+) TERMINAL)
DIELECTRIC STRENGTH	5 mA MAX. AT 500 VAC 60 Hz ONE MINUTE, (BETWEEN FRAME AND (+) TERMINAL)
EXTERNAL COVER	OPEN TYPE
LIFE EXPECTANCE	70,000 HOURS CONTINUOUS OPERATION AT 40 °C WITH 15 ~ 65 %RH.
ROTATION	CLOCKWISE VIEW FROM NAME PLATE SIDE
OVER CURRENT SHUT DOWN	THE CURRENT WILL SHUT DOWN WHEN LOCKING ROTOR.
LEAD WIRE	UL 1061 -F- AWG #26 BLACK WIRE: NEGATIVE(-) RED WIRE: POSITIVE(+) BLUE WIRE: TACHOMETER OUTPUT(F00) YELLOW WIRE: SPEED CONTROL(PWM)

- NOTES: 1. ALL READINGS ARE MEASURED AFTER STABLY WARMING UP THROUGH 10 MINUTES.
2. THE VALUES WRITTEN IN PARENS , (), ARE LIMITED SPEC.
3. ACOUSTICAL NOISE MEASURING CONDITION:

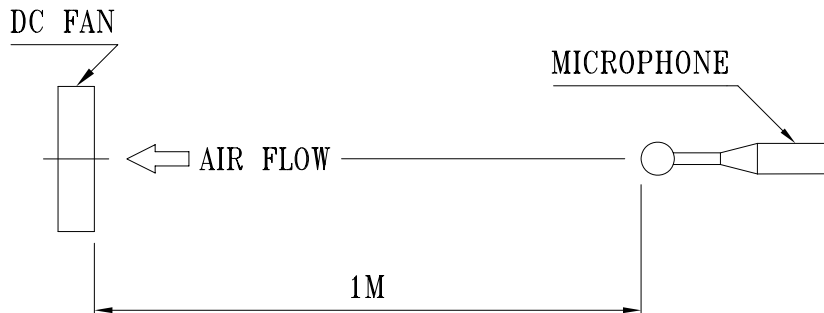

NOISE IS MEASURED AT RATED VOLTAGE IN FREE AIR IN ANECHOIC CHAMBER WITH B & K SOUND LEVEL METER WITH MICROPHONE AT A DISTANCE OF ONE METER FROM THE FAN INTAKE.

PART NO:

DELTA MODEL: AFC0912D-AF00

3. MECHANICAL:

- 3-1. DIMENSIONS _____ SEE DIMENSIONS DRAWING
- 3-2. FRAME _____ PLASTIC UL: 94V-0
- 3-3. IMPELLER _____ PLASTIC UL: 94V-0
- 3-4. BEARING SYSTEM _____ TWO BALL BEARINGS
- 3-5. WEIGHT _____ 120 GRAMS

4. ENVIRONMENTAL:

- 4-1. OPERATING TEMPERATURE _____ -10 TO +60 DEGREE C
- 4-2. STORAGE TEMPERATURE _____ -40 TO +75 DEGREE C
- 4-3. OPERATING HUMIDITY _____ 5 TO 90 % RH
- 4-4. STORAGE HUMIDITY _____ 5 TO 95 % RH

5. PROTECTION:

5-1. LOCKED ROTOR PROTECTION

IMPEDANCE OF MOTOR WINDING PROTECTS MOTOR FROM FIRE IN 96 HOURS OF LOCKED ROTOR CONDITION AT THE RATED VOLTAGE.

5-2. POLARITY PROTECTION

BE CAPABLE OF WITHSTANDING IF REVERSE CONNECTION FOR POSITIVE AND NEGATIVE LEADS.

6. RE OZONE DEPLETING SUBSTANCES:

- 6-1. NO CONTAINING PBBs, PBBOs, CFCs, PBBEs, PBDPEs AND HCFCs.

7. PRODUCTION LOCATION

- 7-1. PRODUCTS WILL BE PRODUCED IN CHINA OR THAILAND OR TAIWAN.

PART NO:

DELTA MODEL: AFC0912D-AF00

8. P & Q CURVE:

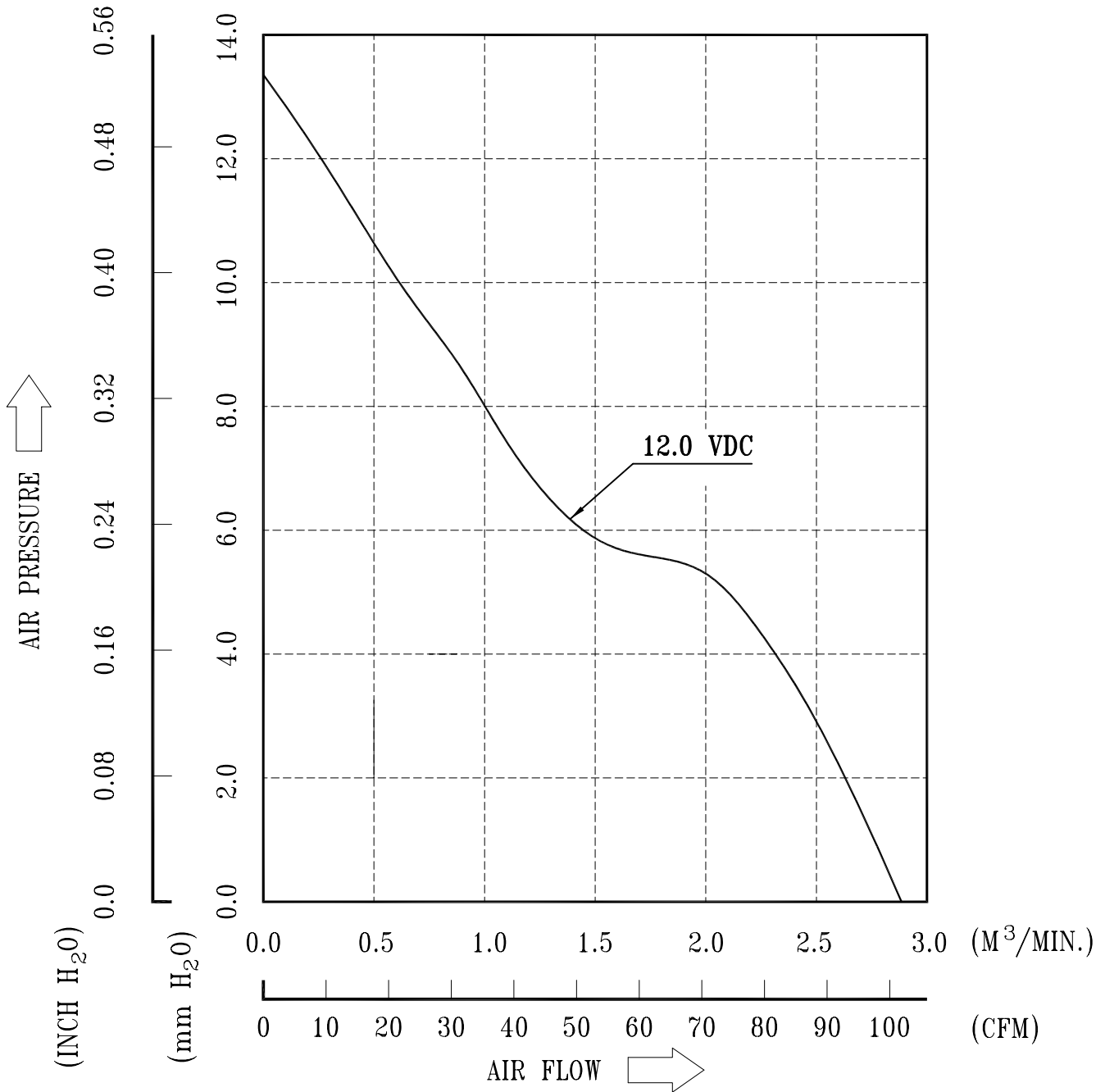

* TEST CONDITION: INPUT VOLTAGE ----- OPERATION VOLTAGE
TEMPERATURE ----- ROOM TEMPERATURE
HUMIDITY ----- 65%RH

PART NO:

DELTA MODEL: AFC0912D-AF00

9. DIMENSION DRAWING:

LABEL:

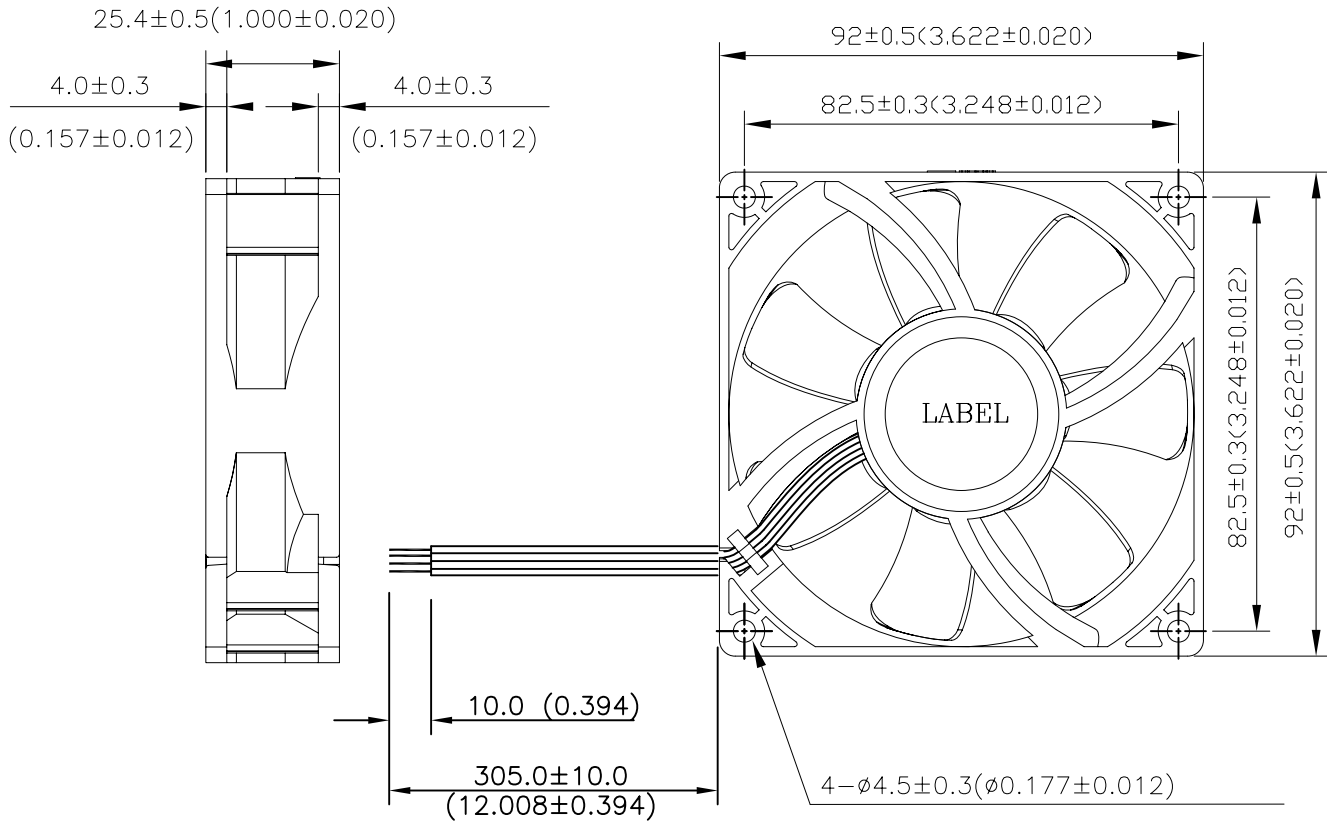
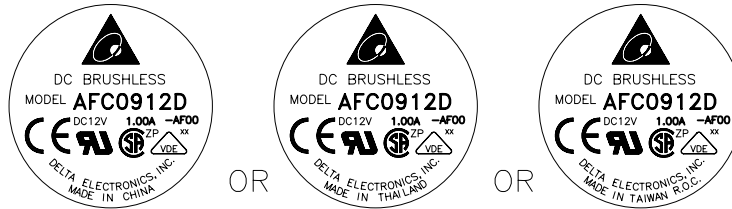

UNIT: MM(INCH)

UL 1061 -F- AWG #26
BLACK WIRE: NEGATIVE(-)
RED WIRE: POSITIVE(+)
BLUE WIRE: TACHOMETER OUTPUT(F00)
YELLOW WIRE: SPEED CONTROL(PWM)

PART NO:

DELTA MODEL: AFC0912D-AF00

10. FREQUENCY GENERATOR (FG) SIGNAL:

1. OUTPUT CIRCUIT - OPEN COLLECTOR MODE:

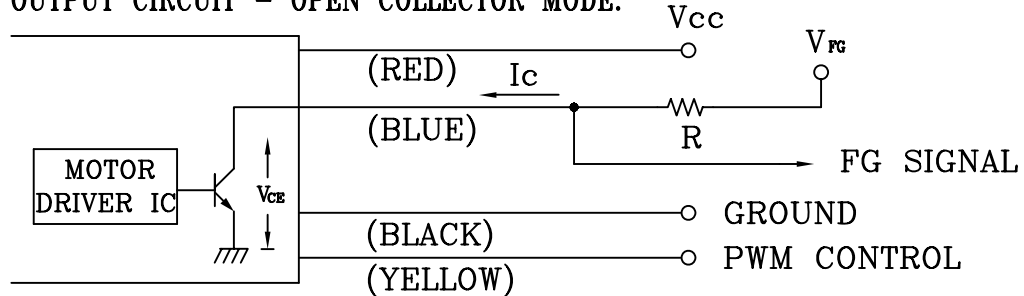

CAUTION: THE FG SIGNAL LEAD WIRE MUST BE KEPT AWAY FROM
" + " LEAD WIRE & " - " LEAD WIRE.

2. SPECIFICATION:

$$V_{CE(sat)} = 0.5V \text{ MAX}$$

$$V_{FG} = 13.2V \text{ MAX}$$

$$I_c = 5mA \text{ MAX.}$$

$$R \geq V_{FG} / I_c$$

3. FREQUENCY GENERATOR WAVEFORM:

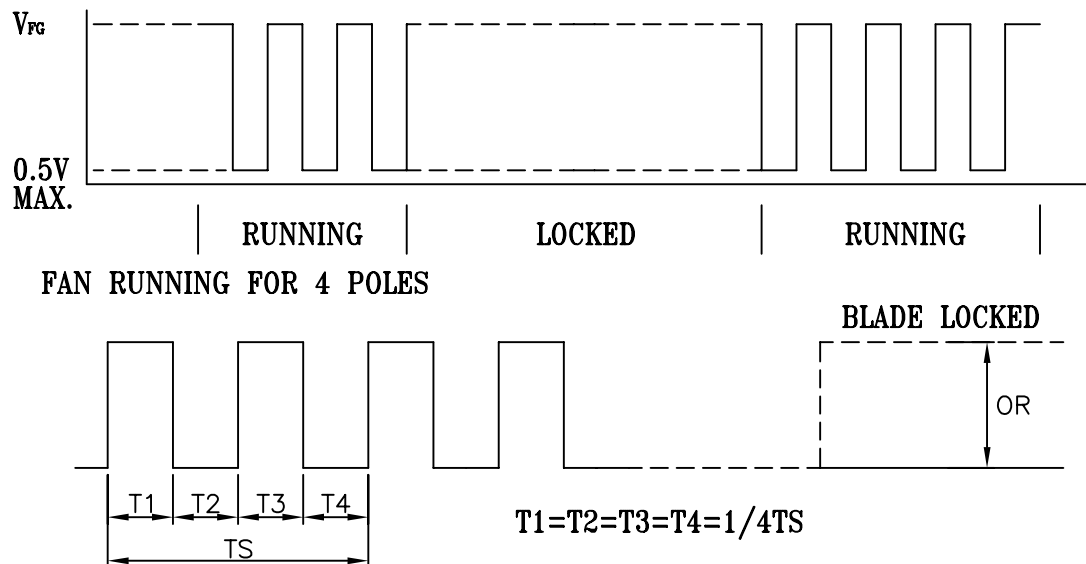

$$N = \text{R.P.M}$$

$$TS = 60 / N (\text{SEC})$$

*VOLTAGE LEVEL AFTER BLADE LOCKED

*4 POLES

PART NO:

DELTA MODEL: AFC0912D-AF00

11. PWM CONTROL SIGNAL:

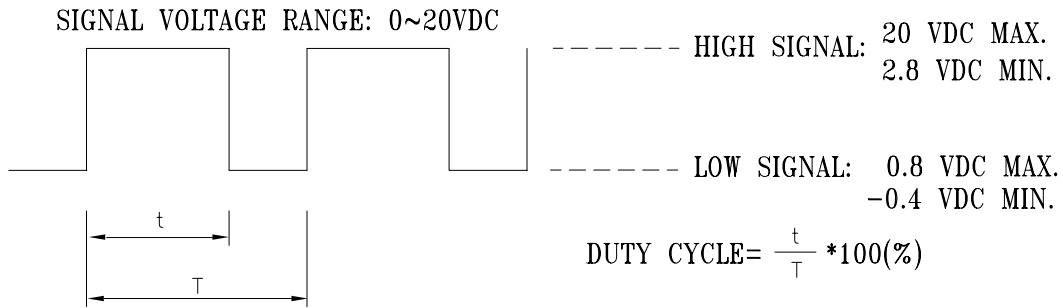

- THE FREQUENCY FOR CONTROL SIGNAL OF THE FAN SHALL BE ABLE TO ACCEPT A 30~300 KHZ.
- THE PREFERRED OPERATING POINT FOR THE FAN IS 20K HZ.
- AT 100% DUTY CYCLE,THE ROTOR WILL SPIN AT MAXIMUM SPEED.
- AT 0% DUTY CYCLE,THE ROTOR WILL SPIN AT MINIMUM SPEED.
- WITH CONTROL SIGNAL LEAD DISCONNECTED,THE FAN WILL SPIN AT MAXIMUM SPEED.
- AT 20K HZ 30% DUTY CYCLE ,THE FAN WILL BE ABLE TO STAR FROM A DEAD STOP .

12. SPEED VS PWM CONTROL SIGNAL: (AT RATED VOLTAGE & PWM FREQUENCY=20KHZ)

DUTY CYCLE (%)	SPEED R.P.M. (REF.)	CURRENT (A) REF.
100	4800	0.75
0~15	650±250	0.01

13. PWM CONTROL LEAD WIRE INPUT IMPEDANCE:

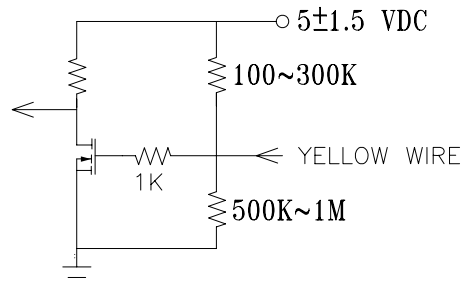

- 13-1. THE FAN SPEED WILL DEFAULT TO MAXIMUM WHEN THE SPEED CONTROLL INPUT IS LEFT UNCONNECTED.



Descriptions:

- 1. Delta will not guarantee the performance of the products if the application condition falls outside the parameters set forth in the specification.**
- 2. A written request should be submitted to Delta prior to approval if deviation from this specification is required.**
- 3. Please exercise caution when handling fans. Damage may be caused when pressure is applied to the impeller, if the fans are handled by the lead wires, or if the fans are hard-dropped to the production floor.**
- 4. Except as pertains to some special designs, there is no guarantee that the products will be free from any such safety problems or failures as caused by the introduction of powder, droplets of water or encroachment of insect into the hub.**
- 5. The above-mentioned conditions are representative of some unique examples and viewed as the first point of reference prior to all other information.**
- 6. It is very important to establish the correct polarity before connecting the fan to the power source. Positive (+) and Negative (-). Damage may be caused to the fans if connection is with reverse polarity, as there is no foolproof method to protect against such error.**
- 7. Delta fans are not suitable where any corrosive fluids are introduced to their environment.**
- 8. Please ensure all fans are stored according to the storage temperature limits specified. Do not store fans in a high humidity environment. We highly recommend performance testing is conducted before shipping, if the fans have been stored over 6 months.**
- 9. Not all fans are provided with the Lock Rotor Protection feature. If you impair the rotation of the impeller for the fans that do not have this function, the performance of those fans will lead to failure.**
- 10. Please be cautious when mounting the fan. Incorrect mounting of fans may cause excess resonance, vibration and subsequent noise.**
- 11. It is important to consider safety when testing the fans. A suitable fan guard should be fitted to the fan to guard against any potential for personal injury.**
- 12. Except where specifically stated, all tests are carried out at relative (ambient) temperature and humidity conditions of 25°C, 65%. The test value is only for fan performance itself.**
- 13. Be certain to connect an “over 4.7µF” capacitor to the fan externally when the application calls for using multiple fans in parallel, to avoid any unstable power.**



GPWV2.E132003

Fans, Electric - Component

[Page Bottom](#)[Print-friendly version](#)[Questions?](#)[Previous Page](#)

Fans, Electric - Component

[See General Information for Fans, Electric - Component](#)

DELTA ELECTRONICS INC

E132003

31-1 SHIEN PAN RD

KUEI SHAN INDUSTRIAL ZONE

TAOYUAN HSIEN, TAIWAN

Model AFB followed by 0405, followed by HA, HHA, LA or MA, followed by (Y), where (Y) may be xxxxx, where x may be A through Z, 0 through 9, "-" or blank; Model AFB followed by 0505, followed by HB, LB or MB, followed by (Y), where (Y) may be xxxxx, where x may be A through Z, 0 through 9, "-" or blank; Model AFB followed by 0512, followed by HB, HHB, LB or MB, followed by (Y), where (Y) may be xxxxx, where x may be A through Z, 0 through 9, "-" or blank; Model AFB followed by 0605, followed by H, L or M, followed by R00, R05, RR0 or RR05, followed by (Y), where (Y) may be xxxxx, where x may be A through Z, 0 through 9, "-" or blank; Model AFB followed by 0805, followed by H, L or M; Model AFB followed by 0612, 0624, followed by EH, SH VH; Model AFB0612LB followed by (Y), where (Y) may be xxxxx, where x may be A through Z, 0 through 9, "-" or blank; Model AFB followed by 0612, 0624, 0812, 0824, 0912 or 0924, followed by H, HB, HH, HHB, LB, LLB, MB, SHB or VHB, followed by (Y), where (Y) may be xxxxx, where x may be A through Z, 0 through 9, "-" or blank; Models ASB0412MA, ASB0412LA, ASB0405MA; Model ASB followed by 0405, 0412, followed by HA, HHA, LA or MA, followed by (Y), where (Y) may be xxxxx, where x may be A through Z, 0 through 9, "-" or blank; Model ASB followed by 0505, followed by HB, LB or MB, followed by (Y), where (Y) may be xxxxx, where x may be A through Z, 0 through 9, "-" or blank; Model ASB followed by 0512, 0524, followed by HB, HHB, LB or MB, followed by (Y), where (Y) may be xxxxx, where x may be A through Z, 0 through 9, "-" or blank; Model ASB followed by 0812, 0824, followed by HB, HHB, LB, LLB, MB, SHB or VHB, followed by (Y), where (Y) may be xxxxx, where x may be A through Z, 0 through 9, "-" or blank; Model ASB followed by 0612 or 0624, followed by H, HH, L or M, followed by (Y), where (Y) may be xxxxx, where x may be A through Z, 0 through 9, "-" or blank; Model ASB followed by 0812, followed by L or M; Model ASB followed by 0912 or 0924, followed by H, L or M, followed by (Y), where (Y) may be xxxxx, where x may be A through Z, 0 through 9, "-" or blank; Model AUB followed by 0505, 0512 or 0524, followed by HB, HHB, LB or MB, followed by (Y), where (Y) may be xxxxx, where x may be A through Z, 0 through 9, "-" or blank; Model AUB followed by 0612, 0624, followed by H, HH, L or M, followed by (Y), where (Y) may be xxxxx, where x may be A through Z, 0 through 9, "-" or blank; Model AUB followed by 0912, 0924, followed by H, HH, L, M or VH, followed by (Y), where (Y) may be xxxxx, where x may be A through Z, 0 through 9, "-" or blank; Model AUB followed by 0612 or 0624, followed by L, M, H

Models BUB0512HHB(Y), BUB0512HB(Y), BUB0512MB(Y), BUB0512LB(Y) series, where (Y) may be xxxxx, x may be A through Z, 0 through 9, "-" or blank.

Model AFB02512VHB-5B05(Y) series, where (Y) may be xxxxx, where x may be A through Z, 0 through 9, "-" or blank.

Models AFC0912D-A(X) series, AUB0712HH-5B22, AUB0712HH-5G85, where (X) may be blank, F00 or R00.

Models AUC0812DD(Y) series, where (Y) may be xxxxx, where x may be A through Z, 0 through 9, "-" or blank.

Marking: Company name or "E132003" or trademark  and model designation.

[Last Updated](#) on 2005-10-06

[Page Top](#)

[Notice of Disclaimer](#)

[Questions?](#)

[Previous Page](#)

[UL Listed and Classified Products](#)

[UL Recognized Components](#)

[Products Certified for Canada](#)

This page and all contents are Copyright © 2005 by Underwriters Laboratories Inc.®

The appearance of a company's name or product in this database does not in itself assure that products so identified have been manufactured under UL's Follow-Up Service. Only those products bearing the UL Mark should be considered to be Listed and covered under UL's Follow-Up Service. Always look for the Mark on the product.

UL permits the reproduction of the material contained in the Online Certification Directory subject to the following conditions: 1. The Guide Information, Designs and/or Listings (files) must be presented in their entirety and in a non-misleading manner, without any manipulation of the data (or drawings). 2. The statement "Reprinted from the Online Certifications Directory with permission from Underwriters Laboratories Inc." must appear adjacent to the extracted material. In addition, the reprinted material must include a copyright notice in the following format: "Copyright © 2005 Underwriters Laboratories Inc.®"



Certification Record

CUSTOMER	CLASS	FILE
Delta Electronics, Inc. 252 Shang Ying Rd, Kuei San Taoyuan Hsien 333 Taiwan	3812-01 FANS AND BLOWERS-	091949_0_000
Refer to Class Description for program details		

CATEGORIES:

- Extra Low Voltage Fans and Ventilators

Notes:

1. The above categories are components of other certified equipment, where the suitability of the combination is to be determined by CSA International.

- Components, DC Fans, Cat Nos and rating are as follows:

Cat Nos	Rated Voltage (V dc)	Rated Current (mA)	Optional Suffixes
AFB SERIES:			
AFB02505HA	5	180	STD R00 F00
AFB02505HB	5	120	STD F00
AFB02505HHB	5	230	STD F00
AFB02505LA	5	60	STD R00 F00
AFB02505LB	5	50	STD F00
AFB02505MA	5	100	STD R00 F00
AFB02505MB	5	80	STD F00
AFB02505HHA	5	240	-
AFB02512HA	12	100	STD R00 F00
AFB02512HHA	12	120	STD R00 F00
AFB02512LA	12	50	STD R00 F00
AFB02512MA	12	60	STD R00 F00
AFB0305HK	5	210	STD F00
AFB0305LLA	5	60	-
AFB0305LA	5	110	-
AFB0305LK	5	90	STD F00
AFB0305MA	5	170	-
AFB0305MK	5	170	STD F00
AFB0305HA	5	240	-
AFB03505LA	5	90	-

PFC0824DE	24	1630	0 to 9, A to Z
GFB0412SHS-A	12	1320	0 to 9, A to Z
GFB0412EHS-A	12	1820	0 to 9, A to Z
BFB0412HA-5C19	12	240	0 to 9, A to Z
BFB0712LD	12	160	0 to 9, A to Z
BFB0712HD	12	370	0 to 9, A to Z
AFB02512VHB-5805	12	210	0 to 9, A to Z
AUC0812DD	12	500	0 to 9, A to Z
BFB0612HB-SM	12	320	0 to 9, A to Z
BFB0712VHD-SM	12	500	0 to 9, A to Z
BFB0812H-SM03	12	400	0 to 9, A to Z
AFC0912D-A	12	1000	0 to 9, A to Z
AUB0712HH-5B22	12	400	0 to 9, A to Z
AUB0712HH-5G85	12	400	0 to 9, A to Z
BUB0512LB	12	100	0 to 9, A to Z
BUB0512MB	12	150	0 to 9, A to Z
BUB0512HB	12	240	0 to 9, A to Z
BUB0512HHB	12	320	0 to 9, A to Z
EFC0412DD-4M2M	12	80	0 to 9, A to Z
EFB1724EHG	24	1920	0 to 9, A to Z
EFB1724GHG	24	2280	0 to 9, A to Z
KHB1748HS	48	530	0 to 9, A to Z
KHB1748HHS	48	650	0 to 9, A to Z
KHB1748VHS	48	780	0 to 9, A to Z
FFB1248EHE-5F92	48	560	0 to 9, A to Z
AFB1512EH	12	3600	0 to 9, A to Z
AFC1512D	12	3600	0 to 9, A to Z
AFB1524EH	24	1920	0 to 9, A to Z

GUTACHTEN MIT FERTIGUNGSÜBERWACHUNG CERTIFICATE OF CONFORMITY WITH FACTORY SURVEILLANCE

Delta Electronics Inc.
186 Ruey Kuang Road
NEIHU TAIPEI (114)
TAIWAN

ist berechtigt, für ihr Produkt /
is authorized to use for their product

Einbauventilator für IT-Geräte
Fan for building-in, IT-equipment

die hier abgebildeten markenrechtlich geschützten Zeichen
für die ab Blatt 2 aufgeführten Typen zu benutzen /
the legally protected Marks as shown below for the types referred to on page 2 ff.



REG.-Nr. 1764 oder/or



oder/or VDE-REG.-Nr. 1764

REG.-Nr. 1764

Geprüft und zertifiziert nach /
Tested and certified according to

DIN EN 60950-1 (VDE 0805 Teil 1):2003-03; EN 60950-1:2001
IEC 60950-1(ed.1)

VDE Prüf- und Zertifizierungsinstitut
VDE Testing and Certification Institute
Zertifizierungsstelle / *Certification*

VDE Zertifikate sind nur gültig bei Veröffentlichung unter:
VDE certificates are valid only when published on:

Aktenzeichen: 1164100-2611-0010 / 65941

File ref.:

Ausweis-Nr. 40012706

Blatt 1

Certificate No.

Page

Weitere Bedingungen siehe Rückseite und Folgeblätter /
further conditions see overleaf and following pages

Offenbach, 2005-01-11

(letzte Änderung/updated 2005-10-25)

<http://www.vde.com/zertifikat>

<http://www.vde.com/certificate>

K O P I E

VDE Prüf- und Zertifizierungsinstitut Gutachten mit Fertigungsüberwachung

Ausweis-Nr. / Blatt /
Certificate No. page
40012706 4

Name und Sitz des Genehmigungs-Inhabers / Name and registered seat of the Certificate holder
Delta Electronics Inc., 186 Ruey Kuang Road, NEIHU TAIPEI (114), TAIWAN

Aktenzeichen / File ref.
1164100-2611-0010 / 65941 / FG13 / S

letzte Änderung / updated Datum / Date
2005-10-25 2005-01-11

Dieses Blatt gilt nur in Verbindung mit Blatt 1 des Gutachtens mit Fertigungsüberwachung Nr. 40012706.
This supplement is only valid in conjunction with page 1 of the Certificate of Conformity with factory surveillance No. 40012706.

Jahresgebühren-Einheiten /
Annual fee units

AFB0912VH-4J1X	DC 12V (Appendix No.50)	1,00
GFB0912EHG	DC 12V (Appendix No.51)	1,00
KHB1748MT-A/HT-A/HHT-A	DC 48V (Appendix No.52)	1,00
BFC1012D-A	DC 12V (Appendix No.53)	1,00
BCB0812EHN/GHN/UHN	DC 12V (Appendix No.54)	1,00
BFB0412HHA-5D1G	DC 8.5V (Appendix No.55)	1,00
DSB0612LD/MD/HD	DC 12V (Appendix No.56)	1,00
AFB0712VHE	DC 12V (Appendix No.57)	1,00
AFC0712DE	DC 12V (Appendix No.57)	1,00
KFB1724SHS/EHS	DC 24V (Appendix No.58)	1,00
KFB1748SHS/EHS	DC 48V (Appendix No.58)	1,00
FFB1224XHE-M	DC 24V (Appendix No.59)	1,00
PFB1212UHE	DC 12V (Appendix No.60)	1,00
PFC1212DE [new version]	DC 12V (Appendix No.60)	1,00
EFC0412DD-4M2M	DC 12V (Appendix No.61)	1,00
EFB1724EHG/GHG	DC 24V (Appendix No.62)	1,00
KFB1724VHT/SHT [new version]	DC 24V (Appendix No.63)	1,00
BUB0512LB/MB/HB/HHB	DC 12V (Appendix No.64)	1,00
AUB0712HH-5B22	DC 12V (Appendix No.65)	1,00
AUB0712HH-5G85	DC 12V (Appendix No.65)	1,00
AFC0912D-A	DC 12V (Appendix No.66)	1,00
KHB1748HS/HHS/VHS	DC 48V (Appendix No.67)	1,00
BFB0612HB-SM	DC 12V (Appendix No.68)	1,00
BFB0712VHD-SM	DC 12V (Appendix No.68)	1,00
BFB0812H-SM03	DC 12V (Appendix No.68)	1,00
AFB02512VHB-5B05	DC 12V (Appendix No.69)	1,00
AUC0812DD	DC 12V (Appendix No.70)	1,00
DSB0412LD/MD/HD	DC 12V (Appendix No.71)	1,00
AFB1312HE/HHE/VHE/SHE	DC 12V (Appendix No.72)	1,00
AFB1324HE/HHE/VHE/SHE	DC 24V (Appendix No.72)	1,00
AFB0612VHF/SHF/EHF/GHF	DC 12V (Appendix No.73)	1,00
GFB0412SHG-A	DC 12V (Appendix No.74)	1,00
PFC0948DE	DC 48V (Appendix No.75)	1,00
PFC0948EHE/GHE/UHE	DC 48V (Appendix No.75)	1,00
AFB0912L-A/M-A/H-A/HH-A/VH-A	DC 12V (Appendix No.76)	1,00
AFB0924L-A/M-,H-,HH-,VH-,SH- A	DC 24V (Appendix No.76)	1,00
AFB0912SH-A	DC 12V (Appendix No.76)	1,00
AUB0912L-A/M-A/H-A/HH-A/VH-A	DC 12V (Appendix No.76)	1,00
AUB0924L-A/M-,H-,HH-,VH-,SH- A	DC 24V (Appendix No.76)	1,00
AUB0912SH-A	DC 12V (Appendix No.76)	1,00
AFC1512DG-5C34	DC 12V (Appendix No.77)	1,00

Fortsetzung siehe Blatt 5 /
continued on page 5



K O P I E

VDE Prüf- und Zertifizierungsinstitut Gutachten mit Fertigungsüberwachung

Ausweis-Nr. / Blatt /
Certificate No. page
40012706 5

Name und Sitz des Genehmigungs-Inhabers / *Name and registered seat of the Certificate holder*
Delta Electronics Inc., 186 Ruey Kuang Road, NEIHU TAIPEI (114), TAIWAN

Aktenzeichen / *File ref.*
1164100-2611-0010 / 65941 / FG13 / S

letzte Änderung / *updated* Datum / *Date*
2005-10-25 2005-01-11

Dieses Blatt gilt nur in Verbindung mit Blatt 1 des Gutachtens mit Fertigungsüberwachung Nr. 40012706.
This supplement is only valid in conjunction with page 1 of the Certificate of Conformity with factory surveillance No. 40012706.

Jahresgebühren-Einheiten /
Annual fee units

Zusatz zur Typenbezeichnung
Addition for type designation

Optional - Anhang 0 bis 9 oder A bis Z
kann hinzugefügt sein für optionale Signal-Ausgänge
*Optional - Suffix 0 to 9 or A to Z
may be added denoting optional signal leads*

Nennspannung
Rated voltage

min. DC 5V -
max. DC 48V (SELV)

Nennstrom
Rated current

siehe Anlagen Nr. 1 - 77
see Appendices No. 1 - 77

Umgebungstemperatur
Ambient temperature

siehe Anlagen
see Appendices

Schutzklasse
Class

III

Schutzart
Degree of protection

Einbaulüfter (für IT-Geräte)
Fan for building-in (for IT equipment)

Einbaubedingungen
Built-in requirements

Beim Einbau des genehmigten Erzeugnisses,
der entsprechend der zugehörigen Installations-
anleitung zu erfolgen hat, ist darauf zu achten,
dass alle Anforderungen gemäss der oben
genannten Bestimmung(en) eingehalten sind.
*For the installation of the certified equipment,
which has to be carried out according to the
respective installation manual, all requirements
of the standard(s) mentioned above have to be
fulfilled.*

Weitere Angaben
Further information

siehe Anlagen Nr. 1 - 77
see Appendices No. 1 - 77

Summe der Jahresgebühren-Einheiten / *Sum of annual fee units*

118,00

Fortsetzung siehe Blatt 6 /
continued on page 6

K O P I E

VDE Prüf- und Zertifizierungsinstitut Gutachten mit Fertigungsüberwachung

Ausweis-Nr. / Blatt /
Certificate No. page
40012706 6

Name und Sitz des Genehmigungs-Inhabers / *Name and registered seat of the Certificate holder*
Delta Electronics Inc., 186 Ruey Kuang Road, NEIHU TAIPEI (114), TAIWAN

Aktenzeichen / *File ref.*
1164100-2611-0010 / 65941 / FG13 / S

letzte Änderung / *updated* Datum / *Date*
2005-10-25 2005-01-11

Dieses Blatt gilt nur in Verbindung mit Blatt 1 des Gutachtens mit Fertigungsüberwachung Nr. 40012706.
This supplement is only valid in conjunction with page 1 of the Certificate of Conformity with factory surveillance No. 40012706.

Jahresgebühren-Einheiten /
Annual fee units

Dieser Zeichengenehmigungs-Ausweis bildet die Grundlage für die EG-Konformitätserklärung und CE-Kennzeichnung durch den Hersteller oder dessen Bevollmächtigten und bescheinigt die Konformität mit den genannten Normen im Sinne der **EG-Niederspannungsrichtlinie 73/23/EWG** mit ihren Änderungen.

*This Marks Approval is the basis for the EC Declaration of Conformity and the CE Marking by the manufacturer or his agent and shows the conformity with the said standards as defined by the **EC Low-Voltage Directive 73/23/EEC** including amendments.*

VDE Prüf- und Zertifizierungsinstitut
VDE Testing and Certification Institute
Fachgebiet FG13
Section FG13

En.

Σ

K O P I E

VDE Prüf- und Zertifizierungsinstitut Gutachten mit Fertigungsüberwachung

Ausweis-Nr. / Beiblatt /
Certificate No. Supplement
40012706

Name und Sitz des Genehmigungs-Inhabers / *Name and registered seat of the Certificate holder*
Delta Electronics Inc., 186 Ruey Kuang Road, NEIHU TAIPEI (114), TAIWAN

Aktenzeichen / *File ref.*
1164100-2611-0010 / 65941 / FG13 / S

letzte Änderung / *updated* Datum / *Date*
2005-10-25 2005-01-11

Dieses Beiblatt ist Bestandteil des Gutachtens mit Fertigungsüberwachung Nr. 40012706.
This supplement is part of the Certificate of Conformity with factory surveillance No. 40012706.

Einbauventilator für IT-Geräte *Fan for building-in, IT-equipment*

Fertigungsstätte(n) *Place(s) of manufacture*

Referenz/*Reference*
30009495 Delta Electronics Components
(Dongguan) Ltd.
Delta Plant 4
Delta Industrial Estate
523308 Shijie Town, Dongguan City
Guangdong
CHINA

Referenz/*Reference*
30011790 Delta Electronics (Jiang Su) Ltd.
No. 1688 Jiangxiang East Road
Wujiang Economy Developm. Zone
Wujiang City, Suzhou City
Jiangsu
CHINA

Referenz/*Reference*
30013236 Delta Electronics (Thailand)
Public Co., Ltd.
111 Moo 9 Wellgrow Industrial Est. Bangna-Trad Rd.
Tambon Bangwa, Bangpakong
TH-24180 Chachoengsao

VDE Prüf- und Zertifizierungsinstitut
VDE Testing and Certification Institute
Fachgebiet FG13
Section FG13

Eh.

S