



Features

- Shielded construction
- Unit height of 5.9 mm
- Inductance range: 0.22 to 10 μ H
- Current up to 45 A
- RoHS compliant*

This series is currently available, but not recommended for new designs. The newer SRP1245A series is recommended.

SRP1250 Series - Shielded Power Inductors

Electrical Specifications

Bourns Part No.	Inductance L (μ H) ± 20 %	I rms (A)	I sat (A)	DCR (m Ω) Max.
SRP1250-R22M	0.22	45	80	1.0
SRP1250-R36M	0.36	41	75	1.1
SRP1250-R47M	0.47	38	65	1.3
SRP1250-R50M	0.50	36	55	1.5
SRP1250-R56M	0.56	36	55	1.5
SRP1250-R68M	0.68	34	54	1.7
SRP1250-R82M	0.82	31	53	2.3
SRP1250-1R0M	1.00	29	50	2.5
SRP1250-1R2M	1.20	27	49	3.3
SRP1250-1R5M	1.50	23	48	4.1
SRP1250-1R8M	1.80	21	40	4.7
SRP1250-2R2M	2.20	20	32	5.5
SRP1250-2R7M	2.70	17	32	7.3
SRP1250-3R3M	3.30	15	32	9.2
SRP1250-4R7M	4.70	12	27	15.0
SRP1250-6R0M	6.00	9.5	14	10.0
SRP1250-6R8M	6.80	11	21	18.5
SRP1250-7R8M	7.80	10	18	20.5
SRP1250-9R0M	9.00	10	18	22.5
SRP1250-100M	10.0	9	16	25.5

General Specifications

Test Voltage0.25 V
 Test Frequency 100 KHz
 Reflow Soldering .. 230 °C; 50 sec. max.
 Operating Temperature
-55 °C to +150 °C
 (Temperature rise included)
 Storage Temperature
-55 °C to +150 °C
 Resistance to Soldering Heat
 +260 °C for 10 sec.

Materials

CoreIron
 WireEnameled copper
 Terminal Cu/Sn
 Rated Current Ind. drops 20 % at Isat
 Temperature Rise40 °C at rated Irms
 Packaging 500 pcs. per 13-inch reel

Product Dimensions

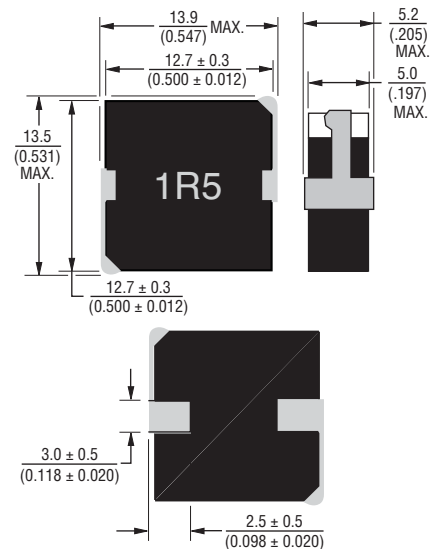

Soldering Profile

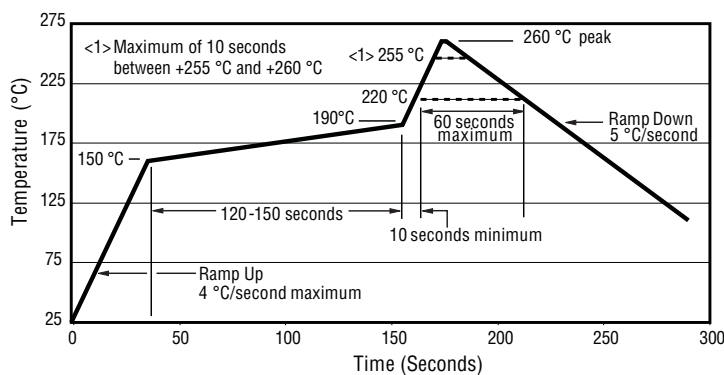

Electrical Schematic

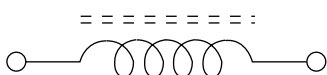

Recommended Layout

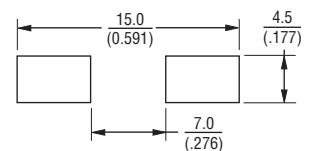

DIMENSIONS: $\frac{\text{MM}}{\text{(INCHES)}}$

*RoHS Directive 2002/95/EC Jan. 27, 2003 including annex and RoHS Recast 2011/65/EU June 8, 2011.

Specifications are subject to change without notice.

The device characteristics and parameters in this data sheet can and do vary in different applications and actual device performance may vary over time.

Users should verify actual device performance in their specific applications.

Applications

- Input/output of DC/DC converters
- Power supplies for:
 - Portable communications equipment
 - Camcorders
 - LCD TVs
 - Car audio systems

SRP1250 Series - Shielded Power Inductors

BOURNS®

L vs. I Charts

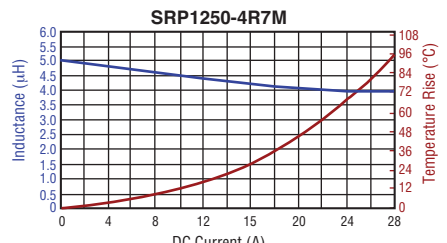
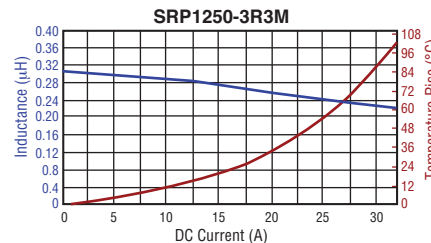
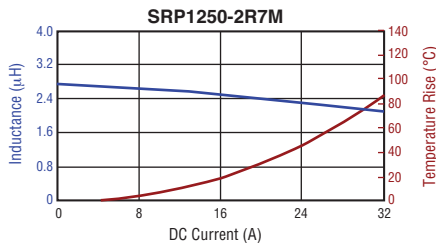
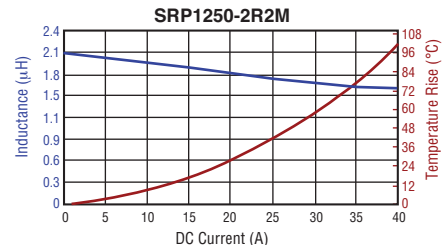
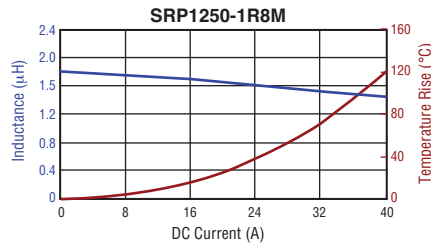
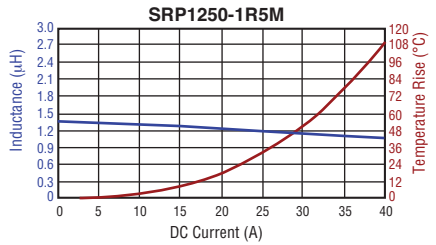
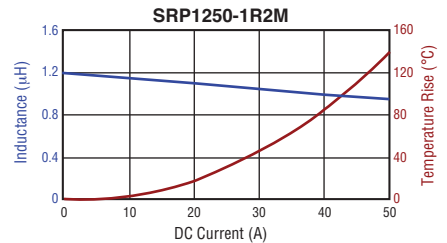
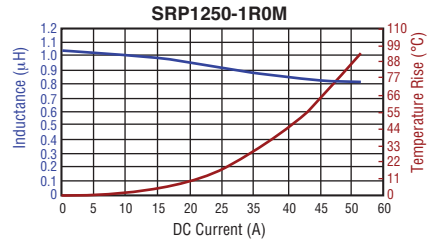
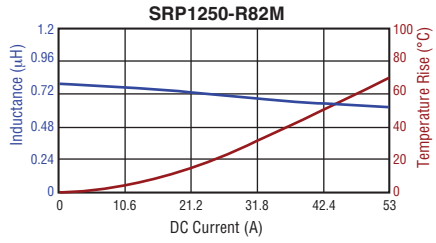
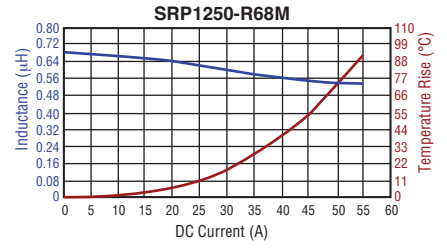
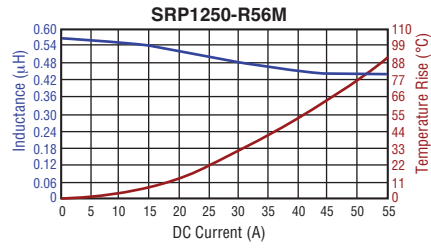
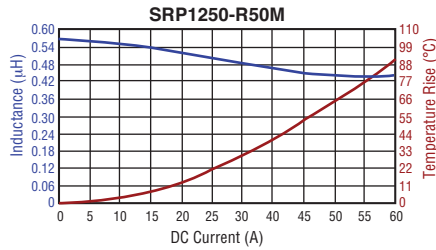
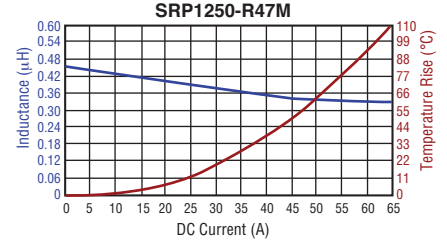
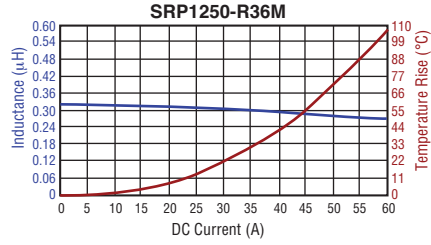
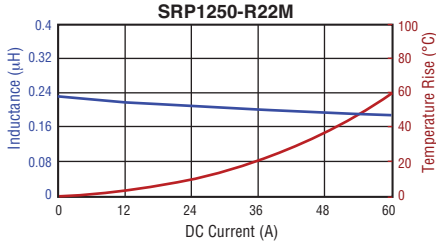

Specifications are subject to change without notice. The device characteristics and parameters in this data sheet can and do vary in different applications and actual device performance may vary over time. Users should verify actual device performance in their specific applications.

SRP1250 Series - Shielded Power Inductors

BOURNS®

L vs. I Charts

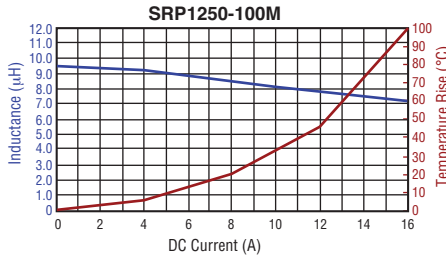
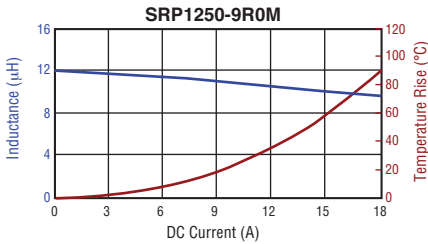
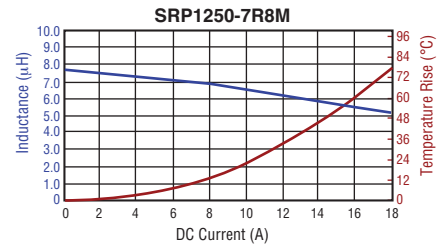
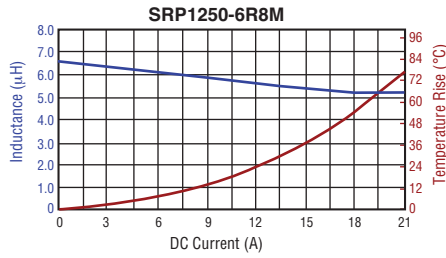
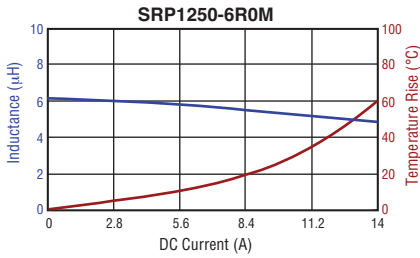

Packaging Specifications

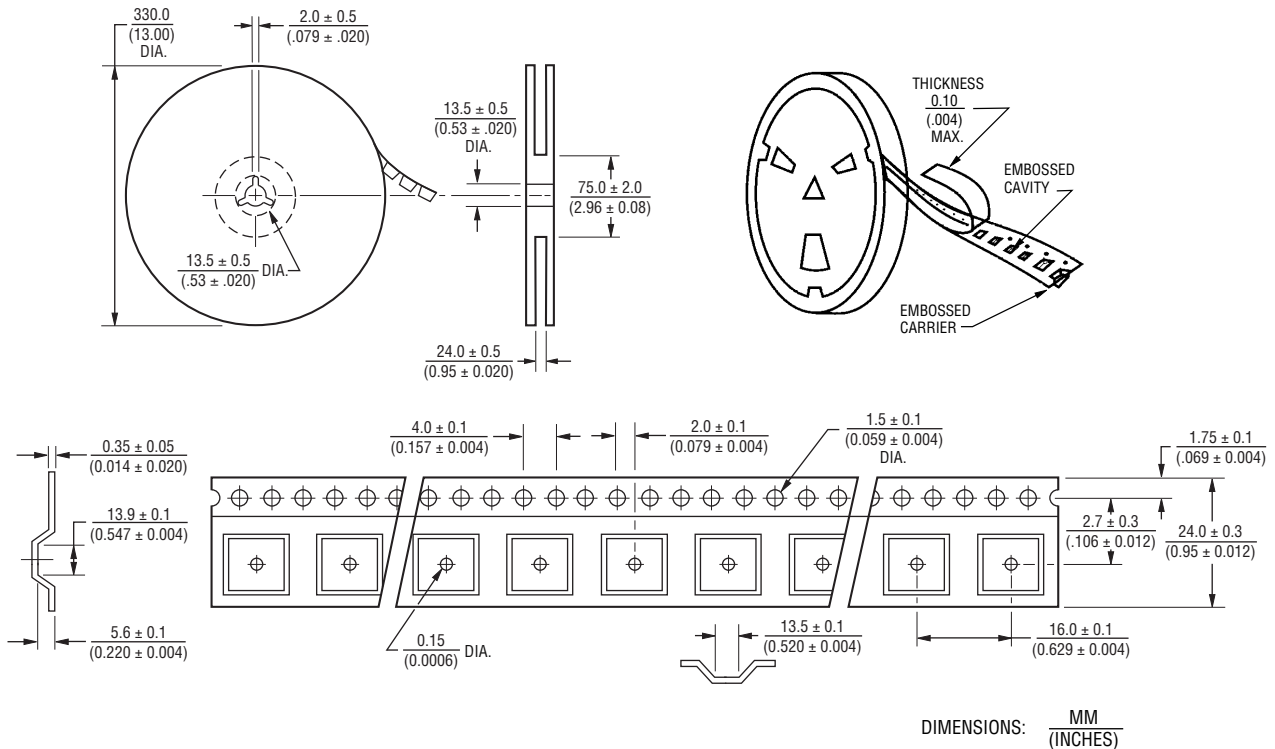

REV. 06/14

Specifications are subject to change without notice.

The device characteristics and parameters in this data sheet can and do vary in different applications and actual device performance may vary over time. Users should verify actual device performance in their specific applications.