

GaAs pHEMT MMIC LOW NOISE AMPLIFIER, 5 - 10 GHz



Typical Applications

This HMC902LP3E is ideal for:

- Point-to-Point Radios
- Point-to-Multi-Point Radios
- Military & Space
- Test Instrumentation

Features

- Low Noise Figure: 1.8 dB
- High Gain: 19 dB
- High P1dB Output Power: 16 dBm
- Single Supply: +3.5 V @ 80 mA
- Output IP3: +28 dBm
- 50 Ohm matched Input/Output
- 16 Lead 3x3mm SMT Package: 9mm²

Functional Diagram

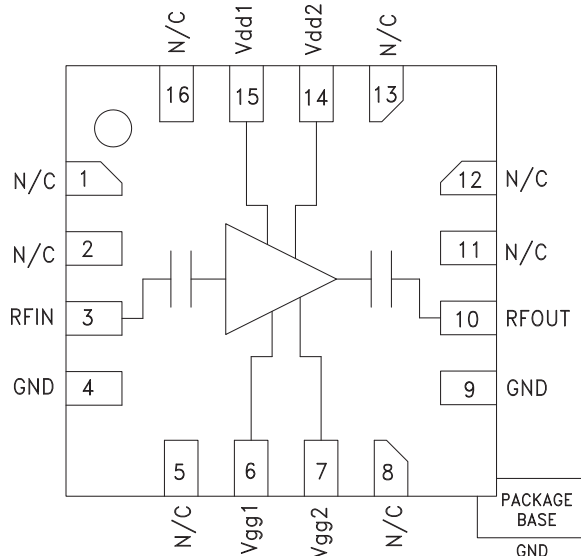

General Description

The HMC902LP3E is a GaAs MMIC Low Noise Amplifier housed in a leadless 3x3 mm plastic surface mount package. The amplifier operates between 5 and 10 GHz, providing 19 dB of small signal gain, 1.8 dB noise figure, and output IP3 of +28 dBm, while requiring only 80 mA from a +3.5V supply. The P1dB output power of +16 dBm enables the LNA to function as a LO driver for balanced, I/Q or image reject mixers. The HMC902LP3E also features I/Os that are DC blocked and internally matched to 50 Ohms, making it ideal for high capacity microwave radios and C-Band VSAT applications.

Electrical Specifications, $T_A = +25^\circ C$, $V_{dd1} = V_{dd2} = +3.5V$, $I_{dd} = 80 mA$ [2]

Parameter	Min.	Typ.	Max.	Units
Frequency Range		5 - 10		GHz
Gain [1]	17	19.5		dB
Gain Variation over Temperature		0.01		dB / °C
Noise Figure [1]		1.8	2.2	dB
Input Return Loss		12		dB
Output Return Loss		15		dB
Output Power for 1 dB Compression [1]		16		dBm
Saturated Output Power (P _{sat}) [1]		17.5		dBm
Output Third Order Intercept (IP3)		28		dBm
Supply Current (I _{dd}) (V _{dd} = 3.5V, set V _{gg2} = 0V, V _{gg1} = 0V Typ.)		80	110	mA

[1] Board loss removed from gain, power and noise figure measurement.

[2] V_{gg1} = V_{gg2} = open for normal, self-biased operation.



GaAs pHEMT MMIC LOW NOISE AMPLIFIER, 5 - 10 GHz

Broadband Gain & Return Loss [1]

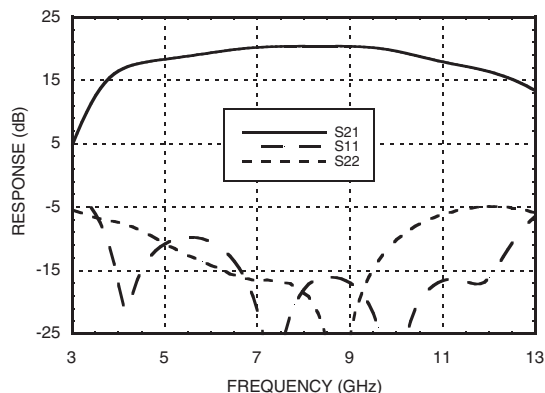

Gain vs. Temperature [1]

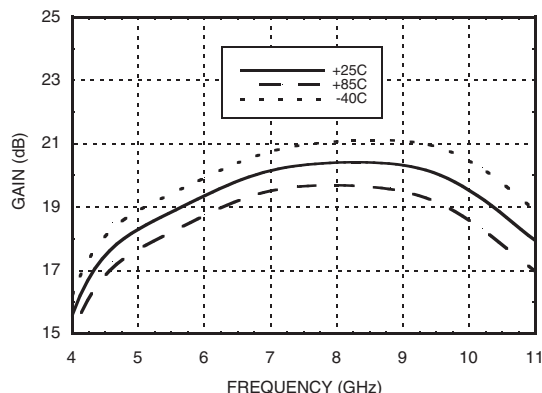

Input Return Loss vs. Temperature

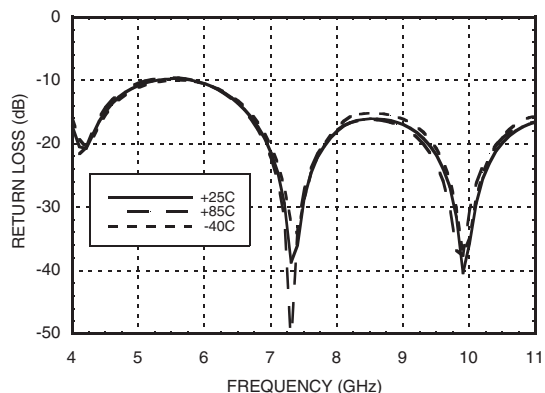

Output Return Loss vs. Temperature

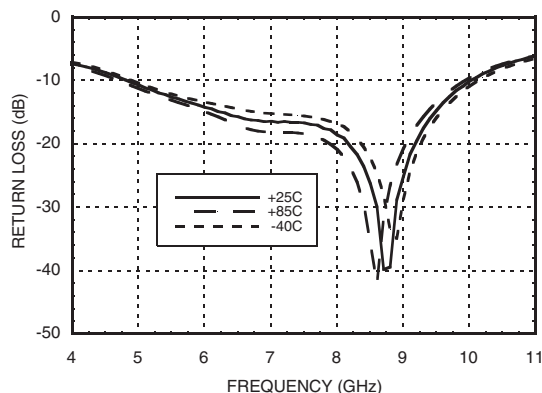

Noise Figure vs. Temperature [1]

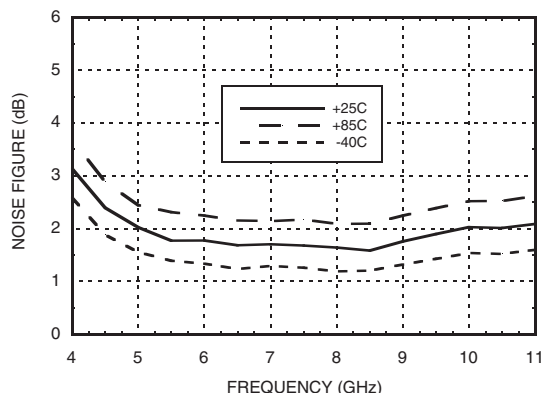

Output IP3 vs. Temperature

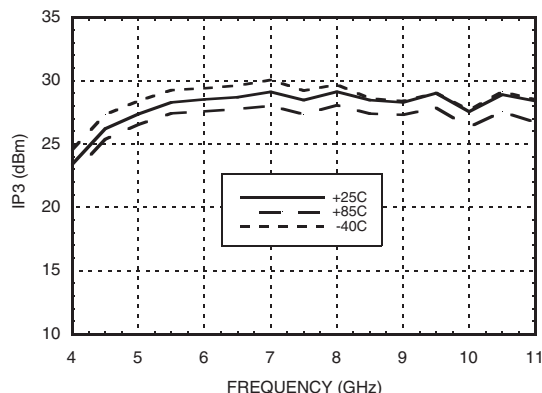

[1] Board loss removed from gain, power and noise figure measurement.



GaAs pHEMT MMIC LOW NOISE AMPLIFIER, 5 - 10 GHz

P1dB vs. Temperature [1]

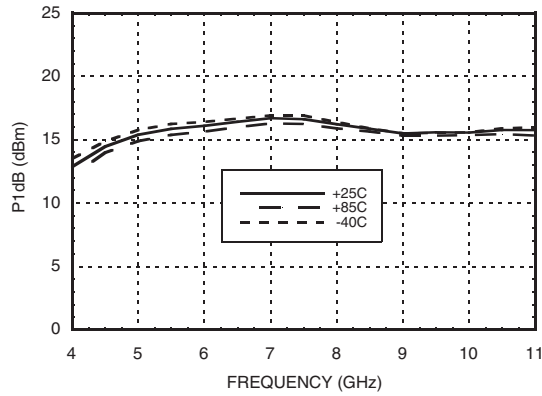

Psat vs. Temperature [1]

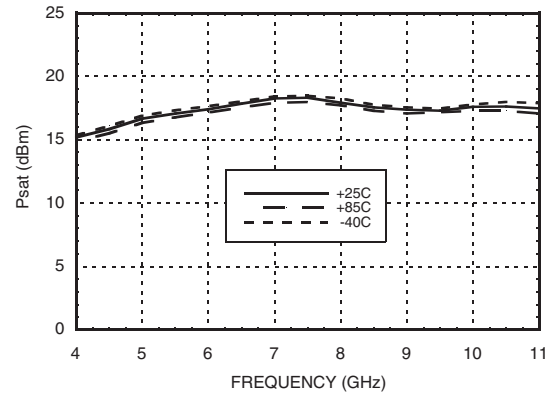

Reverse Isolation vs. Temperature

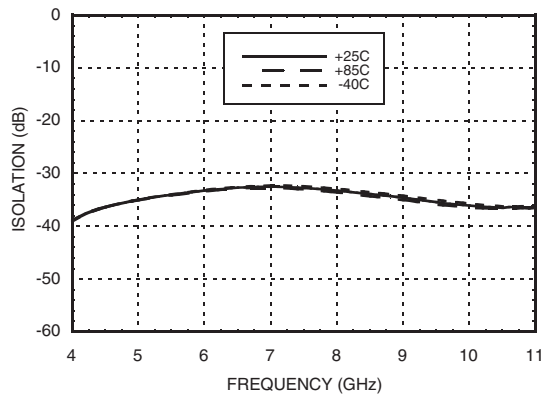

Power Compression @ 7 GHz [1]

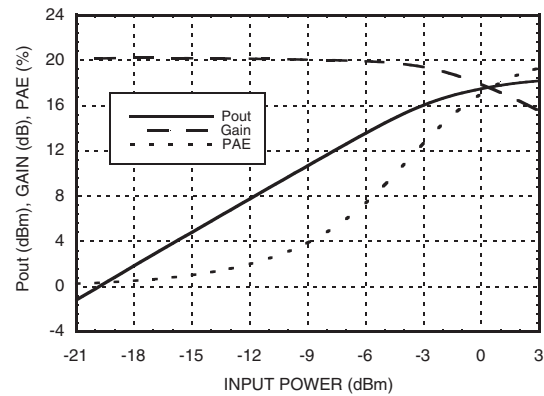

Gain, Noise Figure & Power vs. Supply Voltage @ 7 GHz [1]

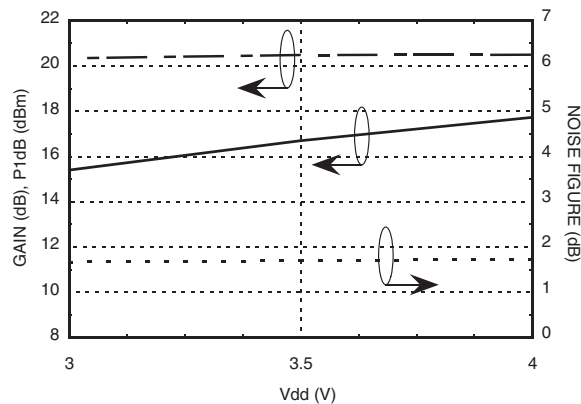

Gain, Output IP3 & Idd vs. Gate Voltage @ 7 GHz [2][3]

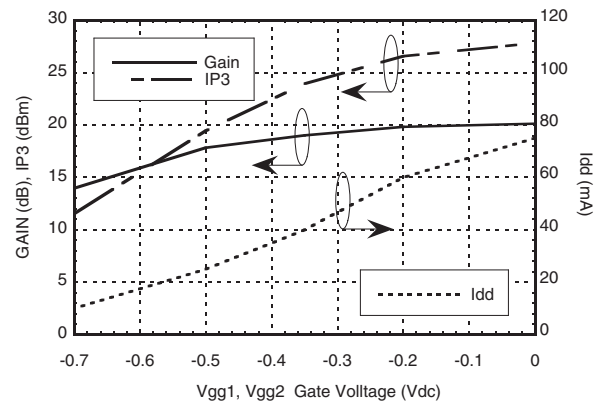

[1] Board loss removed from gain, power and noise figure measurement.

[2] Board loss removed from gain measurement

[3] Data taken at Vdd1 = Vdd2 = 3V



GaAs pHEMT MMIC LOW NOISE AMPLIFIER, 5 - 10 GHz

Current vs. Input Power @ 7 GHz

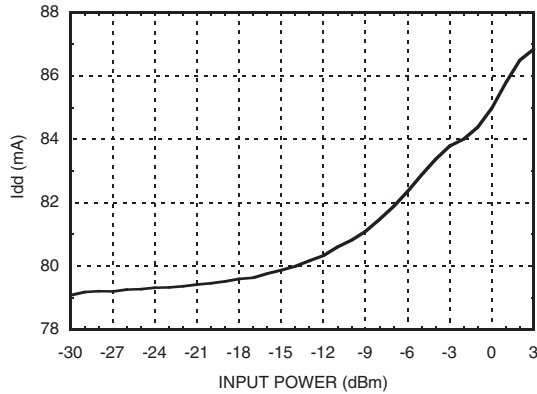

Absolute Maximum Ratings

Drain Bias Voltage	+4.5V
RF Input Power	+10 dBm
Gate Bias Voltage, V _{gg1}	-0.8V to +0.2V
Gate Bias Voltage, V _{gg2}	-0.8V to +0.2V
Channel Temperature	150 °C
Continuous P _{diss} (T = 85 °C) (derate 7 mW/°C above 85 °C)	0.45 W
Thermal Resistance (Channel to ground paddle)	143.8 °C/W
Storage Temperature	-65 to +150 °C
Operating Temperature	-40 to +85 °C



**ELECTROSTATIC SENSITIVE DEVICE
OBSERVE HANDLING PRECAUTIONS**

Outline Drawing

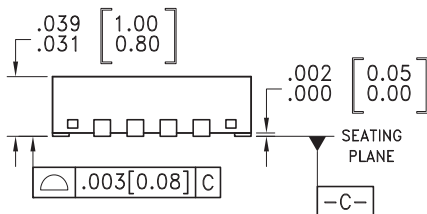
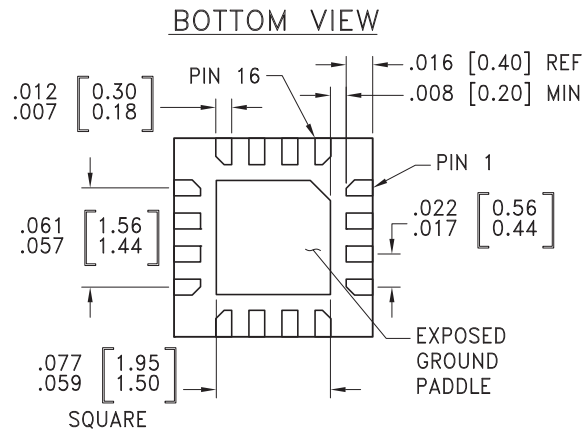
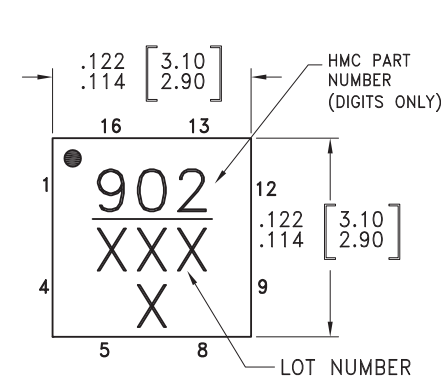

NOTES:

1. PACKAGE BODY MATERIAL: LOW STRESS INJECTION MOLDED PLASTIC SILICA AND SILICON IMPREGNATED.
2. LEAD AND GROUND PADDLE MATERIAL: COPPER ALLOY.
3. LEAD AND GROUND PADDLE PLATING: 100% MATTE TIN
4. DIMENSIONS ARE IN INCHES [MILLIMETERS].
5. LEAD SPACING TOLERANCE IS NON-CUMULATIVE.
6. PAD BURR LENGTH SHALL BE 0.15mm MAX. PAD BURR HEIGHT SHALL BE 0.05mm MAX.
7. PACKAGE WARP SHALL NOT EXCEED 0.05mm
8. ALL GROUND LEADS AND GROUND PADDLE MUST BE SOLDERED TO PCB RF GROUND.
9. REFER TO HITTITE APPLICATION NOTE FOR SUGGESTED PCB LAND PATTERN.



Package Information

Part Number	Package Body Material	Lead Finish	Package Marking ^[1]
HMC902LP3E	RoHS-compliant Low Stress Injection Molded Plastic	100% matte Sn ^[2]	902 XXXX

[1] 4-Digit lot number XXXX

[2] Max peak reflow temperature of 260 °C

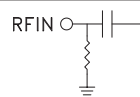
Pin Descriptions

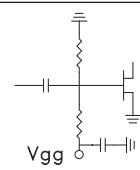
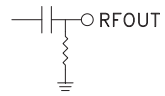
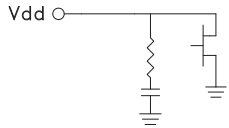
Pin Number	Function	Description	Interface Schematic
1, 2, 5, 8, 11 - 13, 16	N/C	The pins are not connected internally; however, all data shown herein was measured with these pins connected to RF/DC ground externally.	
3	RFIN	This pin is AC coupled and matched to 50 Ohms	
4, 9	GND	Package bottom has exposed metal ground paddle that must be connected to RF/DC ground.	
6, 7	Vgg1, Vgg2	Optional gate control for amplifier. If left open, the amplifier will run self-biased at standard current. Negative voltage applied will reduce drain current. External capacitors required, see application circuits herein.	
10	RFOUT	This pin is AC coupled and matched to 50 Ohms	
14, 15	Vdd2, Vdd1	Power supply voltage for the amplifier. See assembly for required external components.	



Evaluation PCB

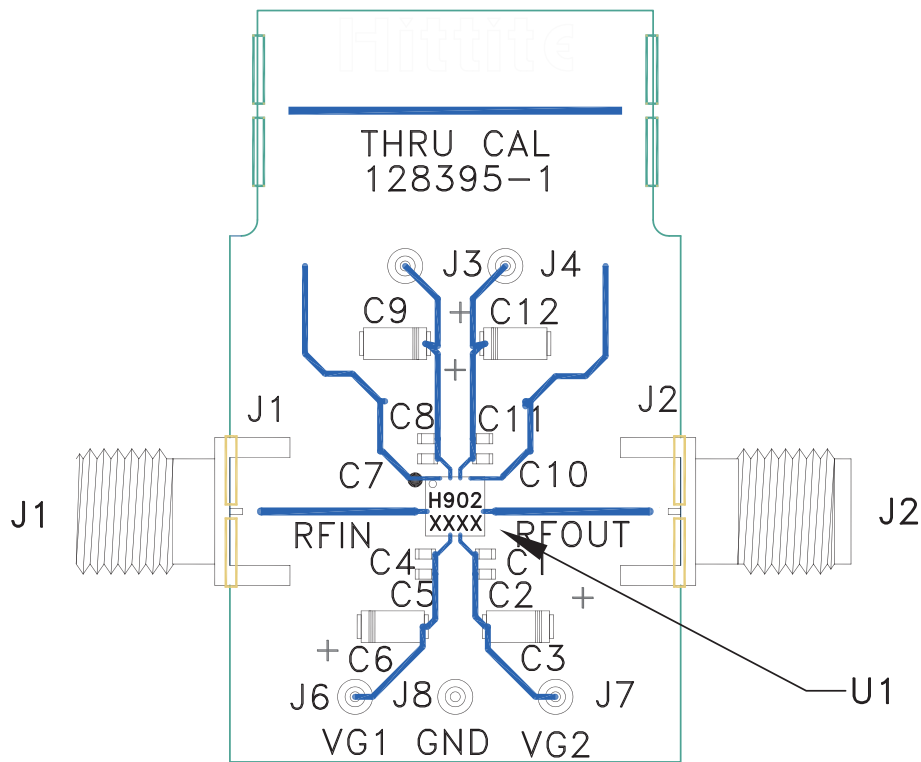

List of Material for Evaluation PCB 129787 [1]

Item	Description
J1, J2	SMA Connector
J3, J4, J6 - J8	DC Pins
C1, C4, C7, C10	100 pF Capacitor, 0402 Pkg.
C2, C5, C8, C11	10 KpF Capacitor, 0402 Pkg.
C3, C6, C9, C12	4.7 μF Capacitor, Tantalum
U1	HMC902LP3E Amplifier
PCB [2]	128395 Evaluation PCB

[1] Reference this number when ordering complete evaluation PCB

[2] Circuit Board Material: Rogers 4350 or Arlon 25FR

The circuit board used in this application should use RF circuit design techniques. Signal lines should have 50 Ohm impedance while the package ground leads and exposed paddle should be connected directly to the ground plane similar to that shown. A sufficient number of via holes should be used to connect the top and bottom ground planes. The evaluation board should be mounted to an appropriate heat sink. The evaluation circuit board shown is available from Hittite upon request.



Application Circuit - Standard (Self-Biased) Operation

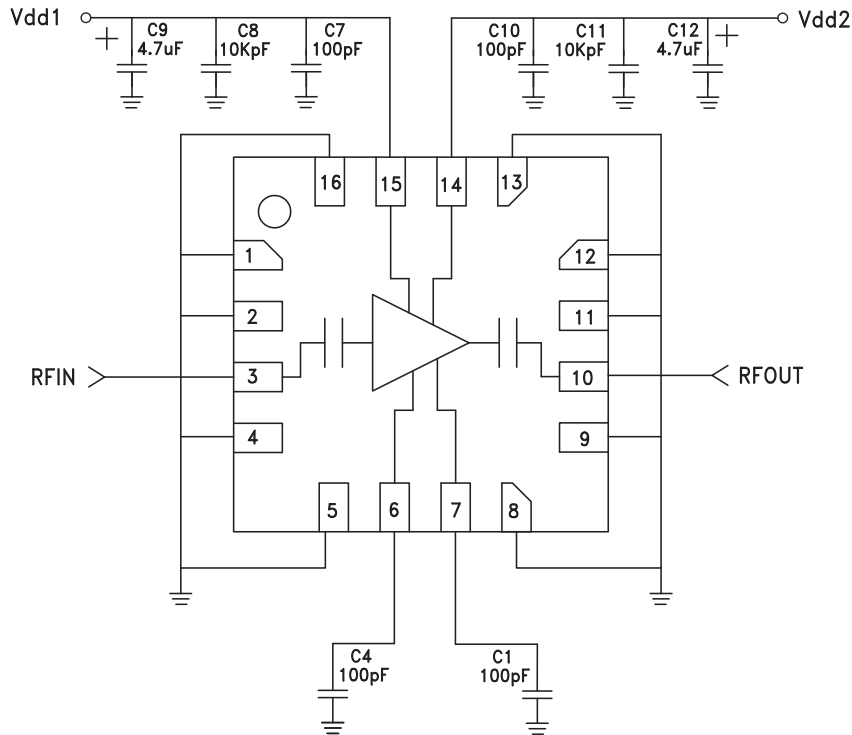

Application Circuit - Gate Control, Reduced Current Operation

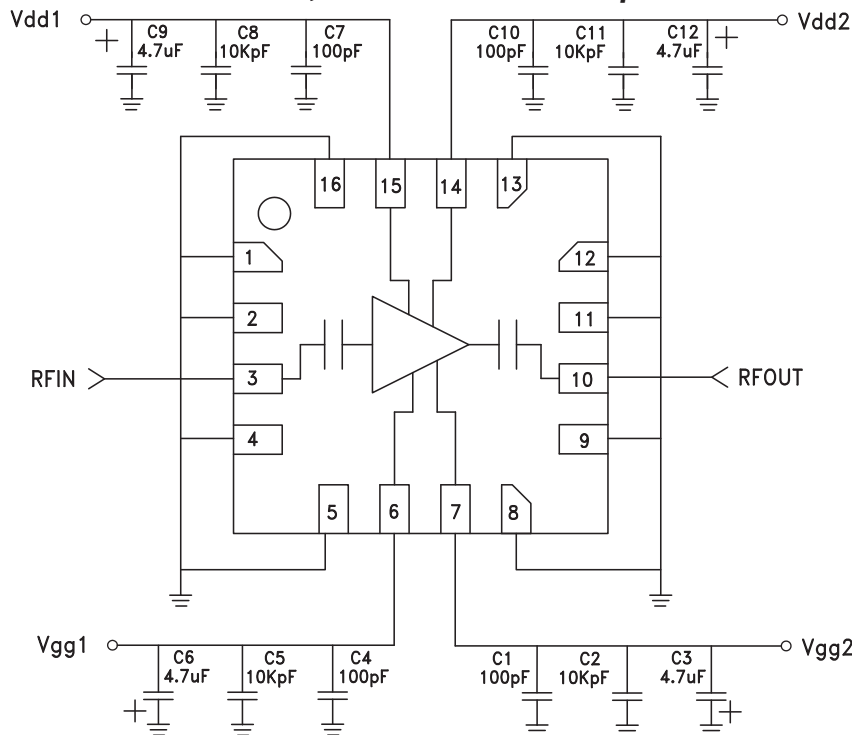

Information furnished by Analog Devices is believed to be accurate and reliable. However, no responsibility is assumed by Analog Devices for its use, nor for any infringements of patents or other rights of third parties that may result from its use. Specifications subject to change without notice. No license is granted by implication or otherwise under any patent or patent rights of Analog Devices. Trademarks and registered trademarks are the property of their respective owners.

For price, delivery, and to place orders: Analog Devices, Inc., One Technology Way, P.O. Box 9106, Norwood, MA 02062-9106 Phone: 781-329-4700 • Order online at www.analog.com Application Support: Phone: 1-800-ANALOG-D

**Notes:**

v00.0210

HMC902LP3E**GaAs pHEMT MMIC LOW NOISE
AMPLIFIER, 5 - 10 GHz****7****AMPLIFIERS - LOW NOISE - SMT**