

Economical, Miniature Limit Switch Boasting Rigid Construction

- The Head, Box, and Cover mate with ridged surfaces to maintain strength.
- A unique Head structure provides a large OT for smooth operation.
- Easy-to-wire conduit opening design.
- Ideal for application in printing machines, forming machines, and light machines.
(High Switches with high sealing characteristics, such as WL or D4C Switches, in locations subject to oil, water, or precipitation.)
- Models with grounding terminals conform to the CE marking.
- Approved by CCC (Chinese standard).
(Ask your OMRON representative for information on approved models.)

 Be sure to read *Safety Precautions* on page 4 to 5 and *Safety Precautions for All Limit Switches*.

Model Number Structure

Model Number Legend (Not all combinations are possible. Ask your OMRON representative for details.)

HL-5□□
(1)(2)







(1) Actuators

- 000: Roller lever
- 030: Adjustable roller lever
- 050: Adjustable rod lever
- 100: Sealed plunger
- 200: Sealed roller plunger
- 300: Coil spring

(2) Ground Terminal Specifications

- Blank : Without ground terminal
- G : With ground terminal/M5 tapping on the rear side

Ordering Information

Actuator	Model
Roller lever 	HL-5000 *
Adjustable roller lever 	HL-5030 *
Adjustable rod lever 	HL-5050 *
Sealed plunger 	HL-5100 *
Sealed roller plunger 	HL-5200
Coil spring 	HL-5300

* HL-5000 Limit Switches are offered with a choice of ground terminal/M5 tapping on the rear side conforming to various standards. When placing an order, add the code to the model number to indicate if ground terminal/M5 tapping on the rear side is required.
-G: with ground terminal/M5 tapping on the rear side.



For the most recent information on models that have been certified for safety standards, refer to your OMRON website.

Specifications

Approved Standards

Agency	Standard	File No.
CCC (CQC)	GB14048.5	2003010303077624

Note: Ask your OMRON representative for information on approved models.

Ratings

Rated voltage	Non-inductive load (A)				Inductive load (A)			
	Resistive load		Lamp load		Inductive load		Motor load	
	NC	NO	NC	NO	NC	NO	NC	NO
125 VAC	5	1.5	0.7	3	2	1		
250 VAC	5	1	0.5	3	1.5	0.8		
12 VDC	5	3		4	3			
24 VDC	5	3		4	3			
125 VDC	0.4	0.2	–	–	–	–		
250 VDC	0.4	0.2	–	–	–	–		

- Note: 1. The above figures are for steady-state currents.
2. Inductive loads have a power factor of 0.4 min. (AC) and a time constant of 7 ms max. (DC).
3. Lamp load has an inrush current of 10 times the steady-state current.
4. Motor load has an inrush current of 6 times the steady-state current.

Inrush current	NC	24 A max.
	NO	12 A max.

Approved Standard Ratings CCC (GB14048.5)

Applicable category and ratings
AC-15 3 A/250 VAC

Characteristics

Degree of protection		IP65
Durability *	Mechanical	10,000,000 operations min. (under rated conditions)
	Electrical	See the following <i>Electrical Durability</i> .
Operating speed		5 mm/s to 0.5 m/s
Operating frequency	Mechanical	120 operations/min
	Electrical	30 operations/min
Insulation resistance		100 MΩ min. (at 500 VDC)
Contact resistance		25 mΩ max. (initial value)
Dielectric strength		1,000 VAC, 50/60 Hz for 1 min between terminals of the same polarity 1,500 VAC, 50/60 Hz for 1 min between current-carrying metal parts and ground 1,500 VAC, 50/60 Hz for 1 min between each terminal and non-current-carrying metal part
Rated frequency		50/60 Hz
Vibration resistance	Malfunction	10 to 55 Hz, 1.5-mm double amplitude
Shock resistance	Destruction	1,000 m/s ² max.
	Malfunction	300 m/s ² max.
Ambient operating temperature		-5°C to +65°C (with no icing)
Ambient operating humidity		35% to 95%RH
Weight		Approx. 130 to 190 g

Note: 1. The above figures are initial values.

2. The above characteristics may vary depending on the model. For further details, contact your OMRON sales representative.

* The values are calculated at an operating temperature of +5°C to +35°C, and an operating humidity of 40% to 70%RH. Contact your OMRON sales representative for more detailed information on other operating environments.

Engineering Data

Electrical Durability (cos dia. =1)

(Operating temperature: +5°C to +35°C,

Operating humidity: 40% to 70%RH)

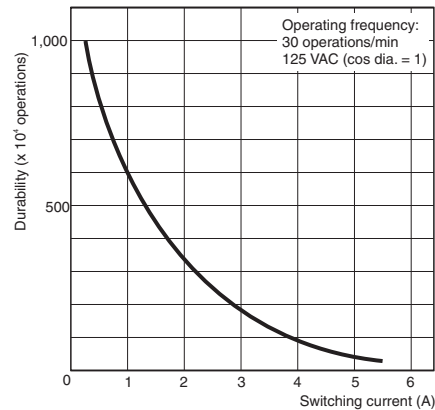

Structure and Nomenclature

Structure

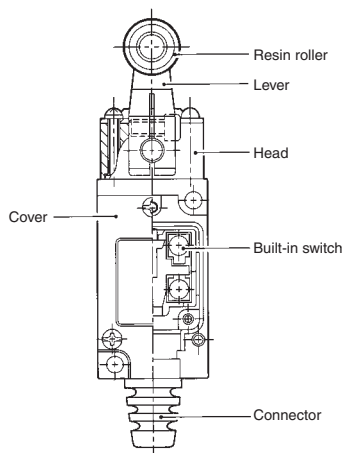

Contact Form

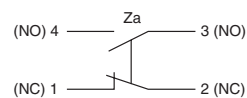

Dimensions and Operating Characteristics

Switches (Dimensions not shown are the same as roller lever models.)

Roller Lever HL-5000



Adjustable Roller Lever HL-5030



Adjustable Rod Lever HL-5050



Sealed Plunger HL-5100



Sealed Roller Plunger HL-5200



Coil Spring HL-5300

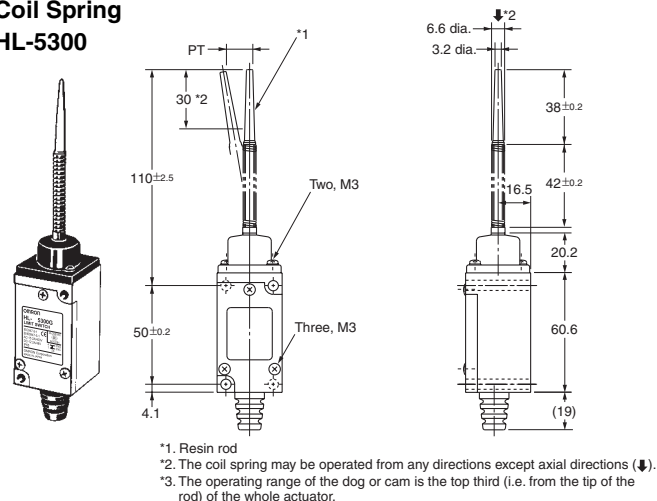

Note: Unless otherwise specified, a tolerance of ± 0.4 mm applies to all dimensions.

Operating characteristics	Model	HL-5000	HL-5030 *	HL-5050 *	HL-5100	HL-5200	HL-5300
Operating force	OF max.	7.35 N	7.35 N	7.35 N	8.83 N	8.83 N	1.47 N
Release force	RF min.	0.98 N	0.98 N	0.98 N	1.47 N	1.47 N	—
Pretravel	PT max.	20°	20°	20°	1.5 mm	1.5 mm	30 mm
Overtravel	OT min.	50°	50°	50°	4 mm	4 mm	—
Movement Differential	MD max.	12°	12°	12°	1 mm	1 mm	—
Operating position	OP	—	—	—	30±0.8 mm	40±0.8 mm	—

* Measured with the types of the 31.5-mm arm or rod length.

OF and RF measured at the arm length of 75 mm for HL-5030, and 145 mm for HL-5050 (reference values).

	HL-5030	HL-5050
OF	3.09 N	1.60 N
RF	0.41 N	0.22 N

Safety Precautions

Refer to *Safety Precautions for All Limit Switches*.

Precautions for Correct Use

Operating Environment

- Seal material may deteriorate if a Switch is used outdoor or where subject to special cutting oils, solvents, or chemicals. Always appraise performance under actual application conditions and set suitable maintenance and replacement periods.
- Install Switches where they will not be directly subject to cutting chips, dust, or dirt. The Actuator and Switch must also be protected from the accumulation of cutting chips or sludge.

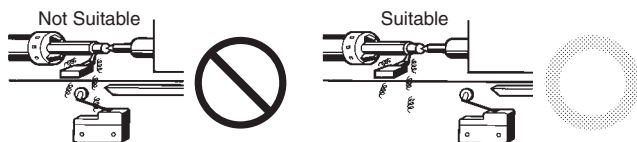

- Constantly subjecting a Switch to vibration or shock can result in wear, which can lead to contact interference with contacts, operation failure, reduced durability, and other problems. Excessive vibration or shock can lead to false contact operation or damage. Install Switches in locations not subject to shock and vibration and in orientations that will not produce resonance.
- The Switches have physical contacts. Using them in environments containing silicon gas will result in the formation of silicon oxide (SiO₂) due to arc energy. If silicon oxide accumulates on the contacts, contact interference can occur. If silicon oil, silicon filling agents, silicon cables, or other silicon products are present near the Switch, suppress arcing with contact protective circuits (surge killers) or remove the source of silicon gas.

Wiring

Wiring Procedure

1. Loosen the cover mounting screws and remove the cover.
2. Disconnect the rubber connector from the box conduit and crimp a solderless terminal. The following solderless terminals are available.
3. After inserting the solderless terminal into the Switch, tighten the terminal screws securely.
4. After wiring the Limit Switch, insert the rubber connector into the groove of the box securely.
5. Tighten the three mounting screws evenly. The optimum tightening torque for each screw is 0.49 to 0.59 N·m.

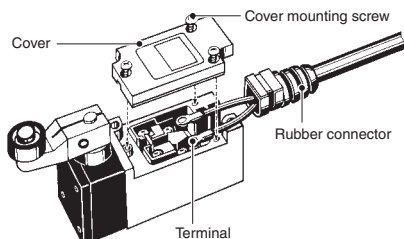

Applicable Lead Wires

Wire name	Applicable wire		
	Number of conductors	Conductor size	External size
Vinyl cabtire cord (VCTF)	2	0.75 mm ²	Round, 6 to 9 dia. Flat, 9.4 max.
	3		
	4		
Vinyl cabtire cable (VCT)	2	0.75 mm ²	Round, 6 to 9 dia. Flat, 9.4 max.
600-V vinyl-insulated sheath cable (VVF)	2	1 dia./1.2 dia./1.6 dia.	

Note: Do not use wires containing silicone, otherwise a contact failure may result.

Applicable Solderless Terminal

The following solderless terminals are available. Do not use fork or any other type of terminals, otherwise an accidental disconnection resulting in a ground fault may result.

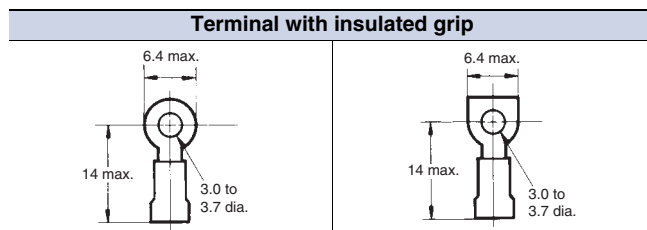

Appropriate Tightening Torque

A loose screw may result in a malfunction. Be sure to tighten each screw to the appropriate tightening torque as shown below.

No.	Type	Appropriate tightening torque
1	Head mounting screw	0.49 to 0.59 N·m
2	Cover mounting screw	0.49 to 0.59 N·m
3	Allen-head bolt	4.90 to 5.88 N·m
4	Terminal screw (M3 screw)	0.49 to 0.59 N·m
5	Switch mounting screw (M5 Allen-head bolt)	4.90 to 5.88 N·m

Note: If the head direction has been changed, check the torque of each screw and make sure that the screws are free of foreign substances, and that each screw is tightened to the proper torque.

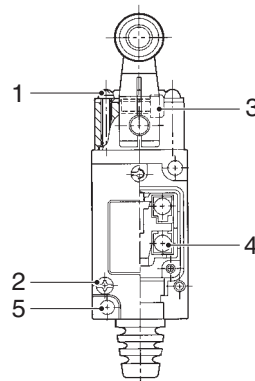

Mounting

To mount the Limit Switch securely, be sure to use two M5 Allenhead bolts and washers.

The tightening torque applied to each bolt is 4.90 to 5.88 N·m. To mount the Limit Switch more securely, use two M5 screw holes on the rear panel and rear holes for positioning if the model is the HL-5□□□G-Series Limit Switches.

Mounting holes

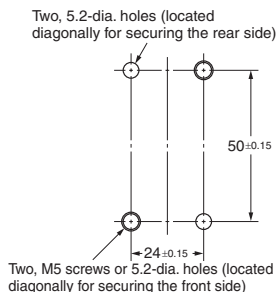

Only the HL-5□□□G has M5 x 0.8 (10 depth min) screw holes on the rear side.

Others

- Do not use the Limit Switch outdoors, otherwise the Limit Switch will become damaged by rust or ozone.
- The Limit Switch is not suitable in places exposed to the spray of rainwater, seawater, or oily water. Consult your OMRON representative for models resisting rainwater, seawater, and oily water.
- If high-sealing performance is required along with shielded wiring or conduit wiring, use the D4C or WL.

Using the Switches

Actuator Position Change

(HL-5000, HL-5030, HL-5050)

To change the angle of the actuator, loosen the Allen-head bolt on the side of the actuator lever. Then the actuator can be set at any angle.

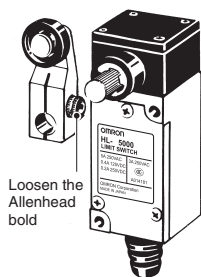

Head Direction Change

(HL-5000, HL-5030, HL-5050, HL5200)

To change the head direction, loosen the two mounting screws. Then the head can be changed at 90° increments in one of four directions.

HL-5000

HL-5030

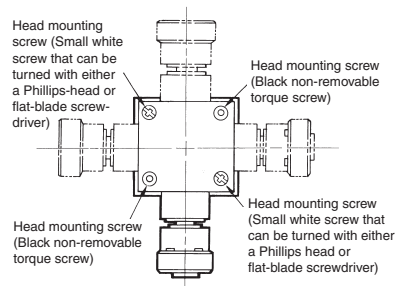

HL-5050

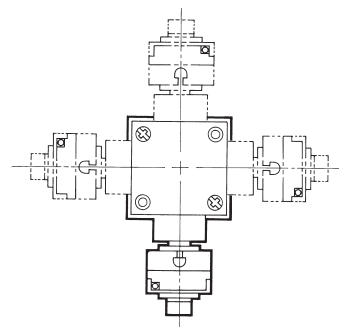

The head of the HL-5200 can be mounted in two directions only. (Refer to the following illustration.)

HL-5200

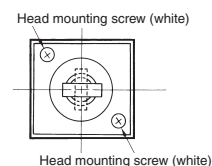

Read and Understand This Catalog

Please read and understand this catalog before purchasing the products. Please consult your OMRON representative if you have any questions or comments.

Warranty and Limitations of Liability

WARRANTY

OMRON's exclusive warranty is that the products are free from defects in materials and workmanship for a period of one year (or other period if specified) from date of sale by OMRON.

OMRON MAKES NO WARRANTY OR REPRESENTATION, EXPRESS OR IMPLIED, REGARDING NON-INFRINGEMENT, MERCHANTABILITY, OR FITNESS FOR PARTICULAR PURPOSE OF THE PRODUCTS. ANY BUYER OR USER ACKNOWLEDGES THAT THE BUYER OR USER ALONE HAS DETERMINED THAT THE PRODUCTS WILL SUITABLY MEET THE REQUIREMENTS OF THEIR INTENDED USE. OMRON DISCLAIMS ALL OTHER WARRANTIES, EXPRESS OR IMPLIED.

LIMITATIONS OF LIABILITY

OMRON SHALL NOT BE RESPONSIBLE FOR SPECIAL, INDIRECT, OR CONSEQUENTIAL DAMAGES, LOSS OF PROFITS OR COMMERCIAL LOSS IN ANY WAY CONNECTED WITH THE PRODUCTS, WHETHER SUCH CLAIM IS BASED ON CONTRACT, WARRANTY, NEGLIGENCE, OR STRICT LIABILITY.

In no event shall the responsibility of OMRON for any act exceed the individual price of the product on which liability is asserted.

IN NO EVENT SHALL OMRON BE RESPONSIBLE FOR WARRANTY, REPAIR, OR OTHER CLAIMS REGARDING THE PRODUCTS UNLESS OMRON'S ANALYSIS CONFIRMS THAT THE PRODUCTS WERE PROPERLY HANDLED, STORED, INSTALLED, AND MAINTAINED AND NOT SUBJECT TO CONTAMINATION, ABUSE, MISUSE, OR INAPPROPRIATE MODIFICATION OR REPAIR.

Application Considerations

SUITABILITY FOR USE

OMRON shall not be responsible for conformity with any standards, codes, or regulations that apply to the combination of products in the customer's application or use of the products.

At the customer's request, OMRON will provide applicable third party certification documents identifying ratings and limitations of use that apply to the products. This information by itself is not sufficient for a complete determination of the suitability of the products in combination with the end product, machine, system, or other application or use.

The following are some examples of applications for which particular attention must be given. This is not intended to be an exhaustive list of all possible uses of the products, nor is it intended to imply that the uses listed may be suitable for the products:

- Outdoor use, uses involving potential chemical contamination or electrical interference, or conditions or uses not described in this catalog.
- Nuclear energy control systems, combustion systems, railroad systems, aviation systems, medical equipment, amusement machines, vehicles, safety equipment, and installations subject to separate industry or government regulations.
- Systems, machines, and equipment that could present a risk to life or property.

Please know and observe all prohibitions of use applicable to the products.

NEVER USE THE PRODUCTS FOR AN APPLICATION INVOLVING SERIOUS RISK TO LIFE OR PROPERTY WITHOUT ENSURING THAT THE SYSTEM AS A WHOLE HAS BEEN DESIGNED TO ADDRESS THE RISKS, AND THAT THE OMRON PRODUCTS ARE PROPERLY RATED AND INSTALLED FOR THE INTENDED USE WITHIN THE OVERALL EQUIPMENT OR SYSTEM.

PROGRAMMABLE PRODUCTS

OMRON shall not be responsible for the user's programming of a programmable product, or any consequence thereof.

Disclaimers

CHANGE IN SPECIFICATIONS

Product specifications and accessories may be changed at any time based on improvements and other reasons.

It is our practice to change model numbers when published ratings or features are changed, or when significant construction changes are made. However, some specifications of the products may be changed without any notice. When in doubt, special model numbers may be assigned to fix or establish key specifications for your application on your request. Please consult with your OMRON representative at any time to confirm actual specifications of purchased products.

DIMENSIONS AND WEIGHTS

Dimensions and weights are nominal and are not to be used for manufacturing purposes, even when tolerances are shown.

PERFORMANCE DATA

Performance data given in this catalog is provided as a guide for the user in determining suitability and does not constitute a warranty. It may represent the result of OMRON's test conditions, and the users must correlate it to actual application requirements. Actual performance is subject to the OMRON Warranty and Limitations of Liability.

ERRORS AND OMISSIONS

The information in this document has been carefully checked and is believed to be accurate; however, no responsibility is assumed for clerical, typographical, or proofreading errors, or omissions.

2012.8

In the interest of product improvement, specifications are subject to change without notice.

OMRON Corporation
Industrial Automation Company

<http://www.ia.omron.com/>

(c)Copyright OMRON Corporation 2012 All Right Reserved.