

DETAILS

Product Number	CS14130_HB-IP-2X6-W
Family	HB
Type	Assembly
Color	white
Diameter	173 + 71,4 mm
Height	11,4 mm
Style	rectang
Optic Material	PMMA
Holder Material	
Fastening	pin, screw
Status	production ready
ROHS Compliant	Yes
Date Updated	30/03/2017



OPTICAL PROPERTIES

LED	Viewing	Light	Efficiency		Connector
	Angle	Beam	ciency	cd/lm	
XT-E	58 deg	Wide	94 %	0.870	-
XM-L	sim: 57	Wide	sim: 93 %	-	-
XM-L2	61 deg	Wide	94 %	0.800	-
XP-G2	58 deg	Wide	93 %	0.870	-
XB-D	sim: 52	Wide	sim: 90 %	-	-
XP-G	60 deg	Wide	94 %	0.840	-
XP-L	67 deg	Wide	94 %	0.750	-
XP-E2	sim: 56	Wide	sim: 94 %	-	-
XHP35 HD	sim: 60	Wide	sim: 94 %	sim: 0.930	-
XHP35 HI	sim: 57	Wide	sim: 94 %	sim: 0.980	-
XP-G3	59 deg	Wide	94 %	0.840	-
MHB-A	sim: 60	Wide	sim: 91 %	sim: 0.860	-
XP-L2	62 deg	Wide	94 %	0.770	-
H35C1 (LEMWA33)	sim: 59	Wide	sim: 94 %	sim: 0.960	-
LUXEON Rebel	sim: 50	Wide	sim: 93 %	-	-
LUXEON T	60 deg	Wide	94 %	0.860	-
LUXEON Rebel ES	57 deg	Wide	94 %	0.860	-
LUXEON R	58 deg	Wide	94 %	0.900	-
LUXEON Z ES	52 deg	Wide	94 %	1.000	-
LUXEON TX	54 deg	Wide	94 %	0.960	-
LUXEON XR-TX (L2T0-xyy012M)	60 deg	Wide	94 %	0.900	-
NVSxx19B/NVSxx19C	58 deg	Wide	94 %	0.870	-
NF2x757A	sim: 50	Wide	sim: 93 %	-	-
NVSxE21A	51 deg	Wide	94 %	1.140	-
Oslon Square PC	sim: 56	Wide	sim: 93 %	-	-



PRODUCT DATASHEET

HB series

last update 30/3/2017

OPTICAL PROPERTIES

LED	Viewing Angle	Light Beam	Efficiency	cd/lm	Connector
Oslon Square EC	sim: 56	Wide	sim: 93 %	-	-
Duris S8	sim: 56	Wide	sim: 95 %	sim: 1.140	-
Oslon SSL 80	sim: 52	Wide	sim: 94 %	sim: 1.200	-
Oslon Square Gen3	sim: 56	Wide	sim: 94 %	1.080	-
Z5M1/Z5M2	59 deg	Wide	94 %	0.870	-
Acrich MJT 4040	sim: 52	Wide	sim: 93 %	sim: 1.200	-
Z5M	sim: 50	Wide	sim: 94 %	sim: 1.000	-
Z8Y22P	57 deg	Wide	94 %	0.880	-
TL1L3	sim: 54	Wide	sim: 89 %	-	-
TL1L2	sim: 55	Wide	sim: 94 %	sim: 0.980	-
TL1L4	56 deg	Wide	94 %	0.950	-

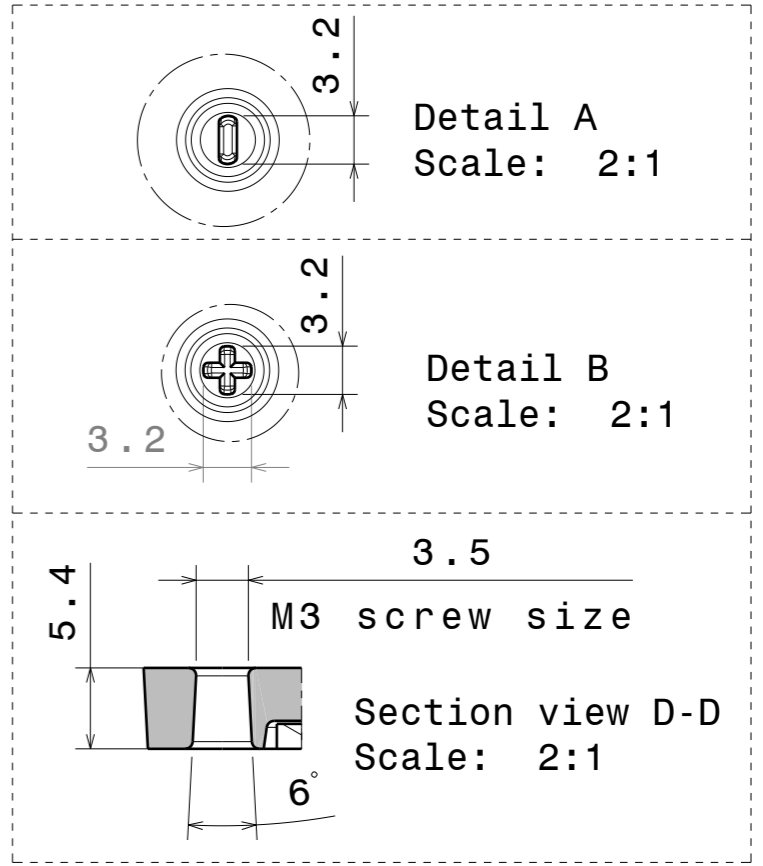
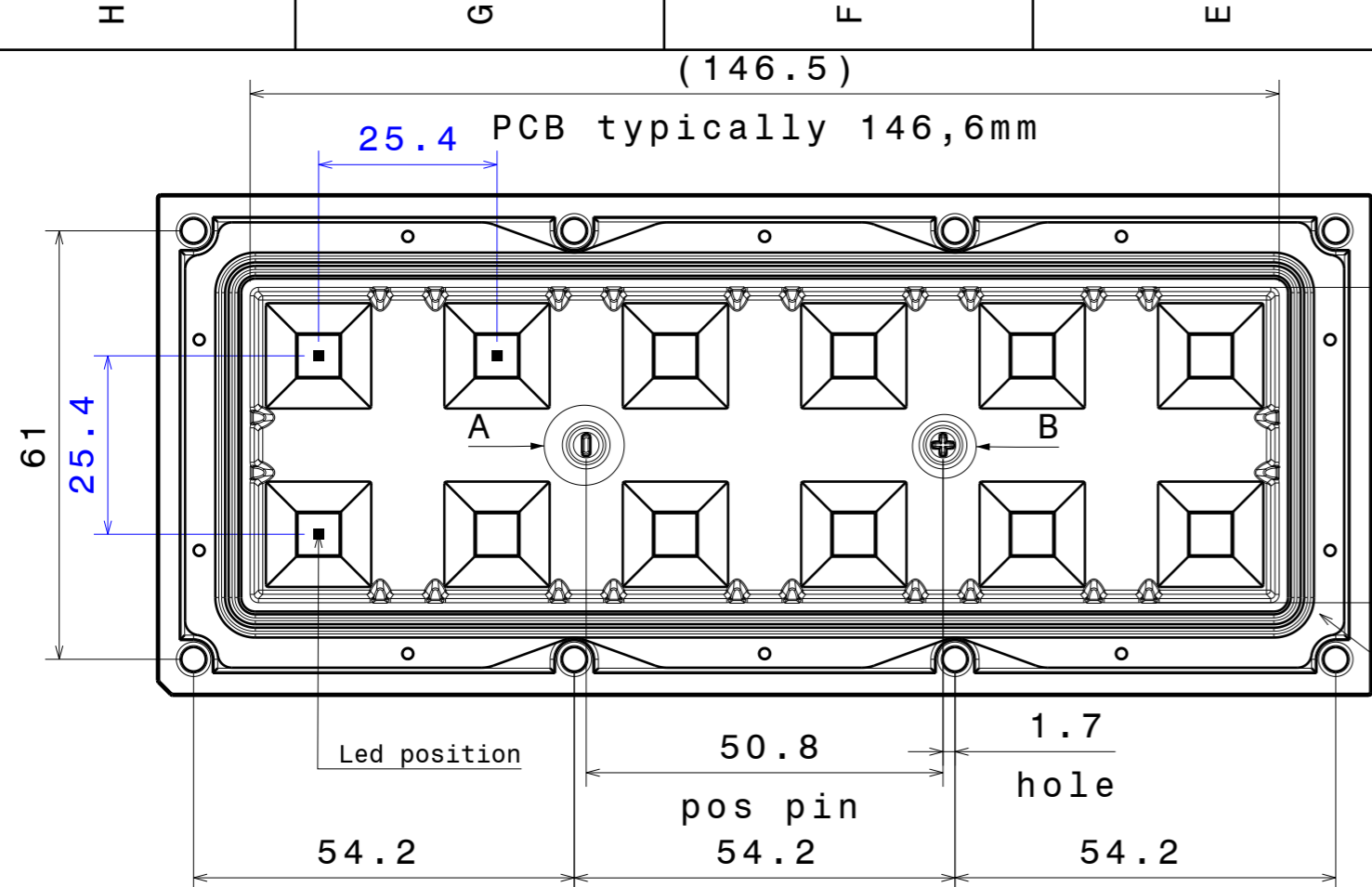

Wiring:
PCB is fully sealed between the lens with silicone seal and the heatsink. Wiring needs to be done through the PCB and heat sink to maintain high IP rating.

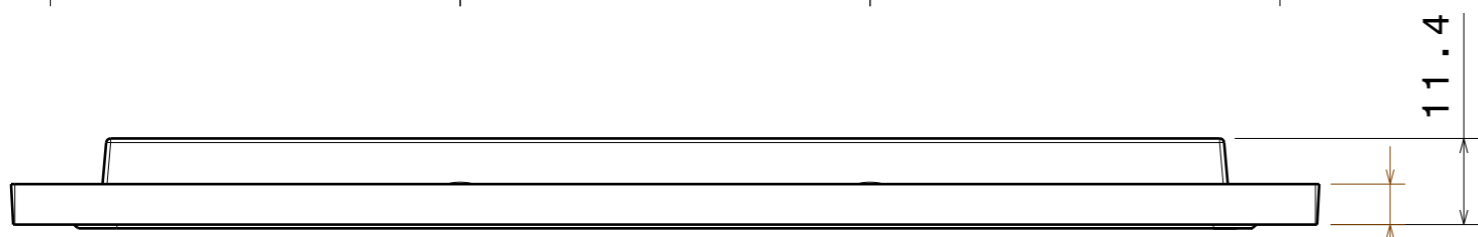

Fasten middle screws first. Recommended torque with pan head screw: 0.57Nm (for 1.6mm thick PCB, no thermal pad)

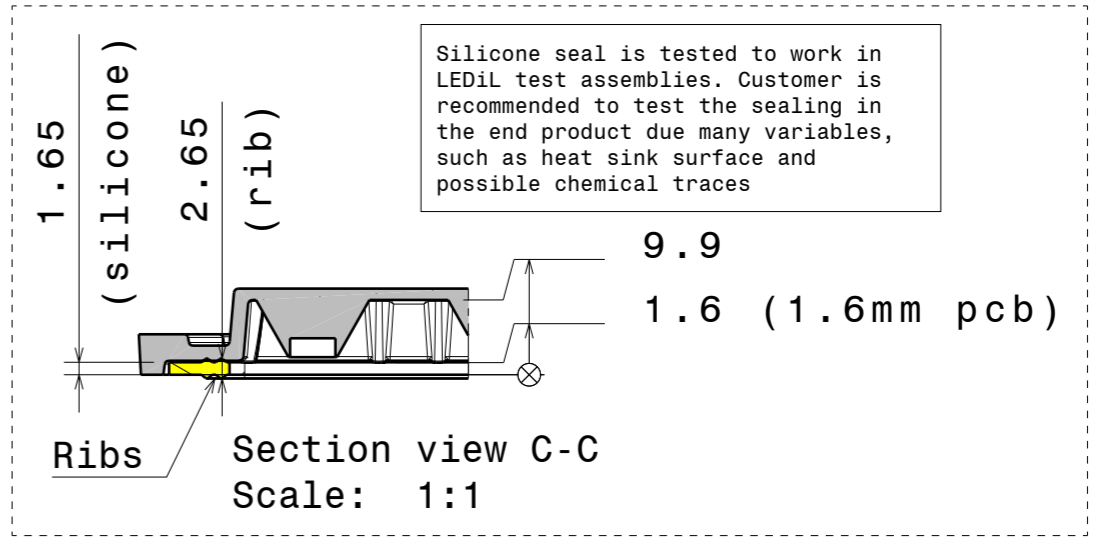
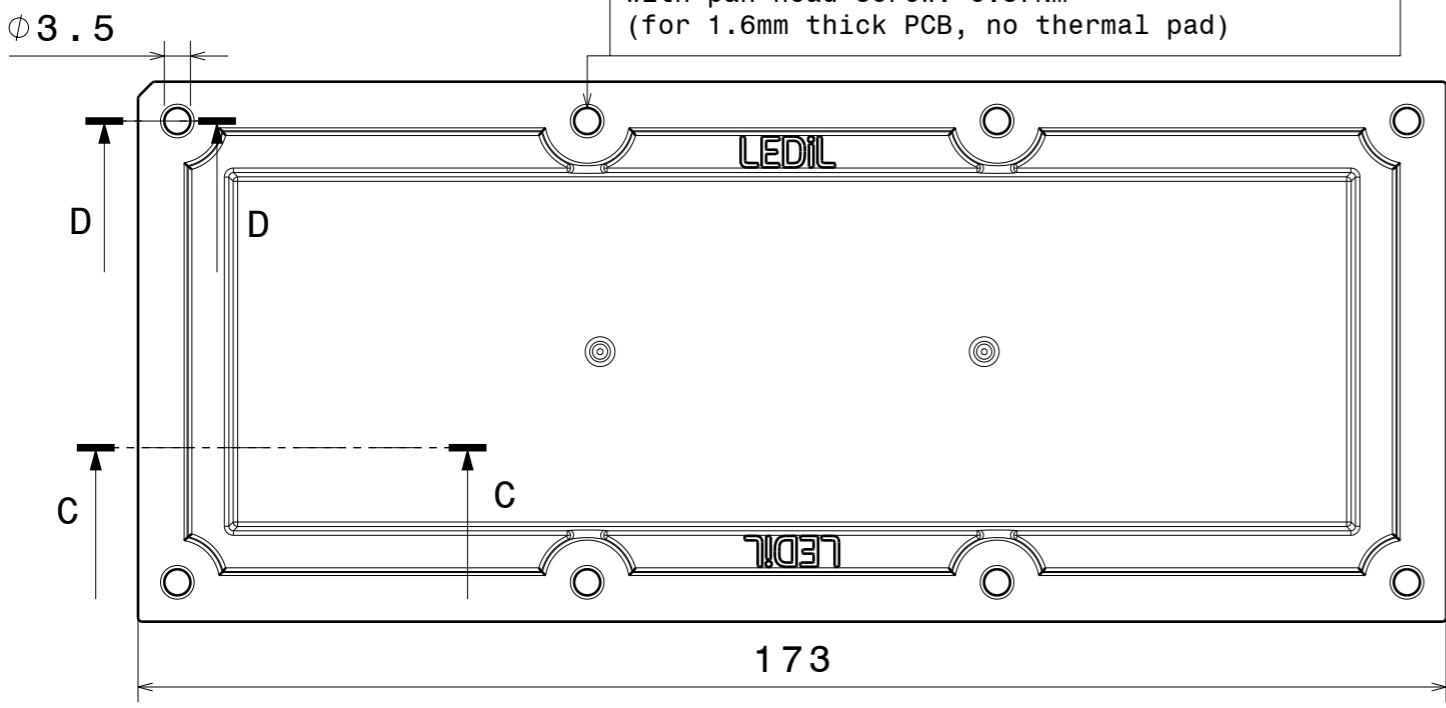

Silicone seal is tested to work in LEDiL test assemblies. Customer is recommended to test the sealing in the end product due many variables, such as heat sink surface and possible chemical traces

INDEX	PART NO	DESCRIPTION	MATERIAL	COLOUR
1	CS14130	HB-IP-2x6-W	PMMA 8N, Silicone seal	

Tolerances if not otherwise shown
According to DIN ISO 2768-1
Linear measures:
Up to 30mm class M, otherwise class C.
According to DIN ISO 2768-2
Form and position: class L

LEDiL
Ledil Oy
Salorankatu 10
FIN 24240 SALO
Finland

THIRD ANGLE PROJECTION:

DRAWING TITLE
CS14130_HB-IP-2x6-W

This drawing is the property of LEDiL Oy. It may not be reproduced, copied or communicated without a written agreement with LEDiL Oy."

SIZE	PART NUMBER
A3	CS14130

SCALE	1:1	WEIGHT		SHEET	1/1
-------	-----	--------	--	-------	-----

Luminaire: LEDiL Oy CS14130_HB-IP-2X6-W_(XT-E)

Lamps: 1 x CREE_XT-E_6x2_(XTEAWT-00-0000-000000HE4)_1253.92lm@250mA_P=8.86265W_I=249.8mA

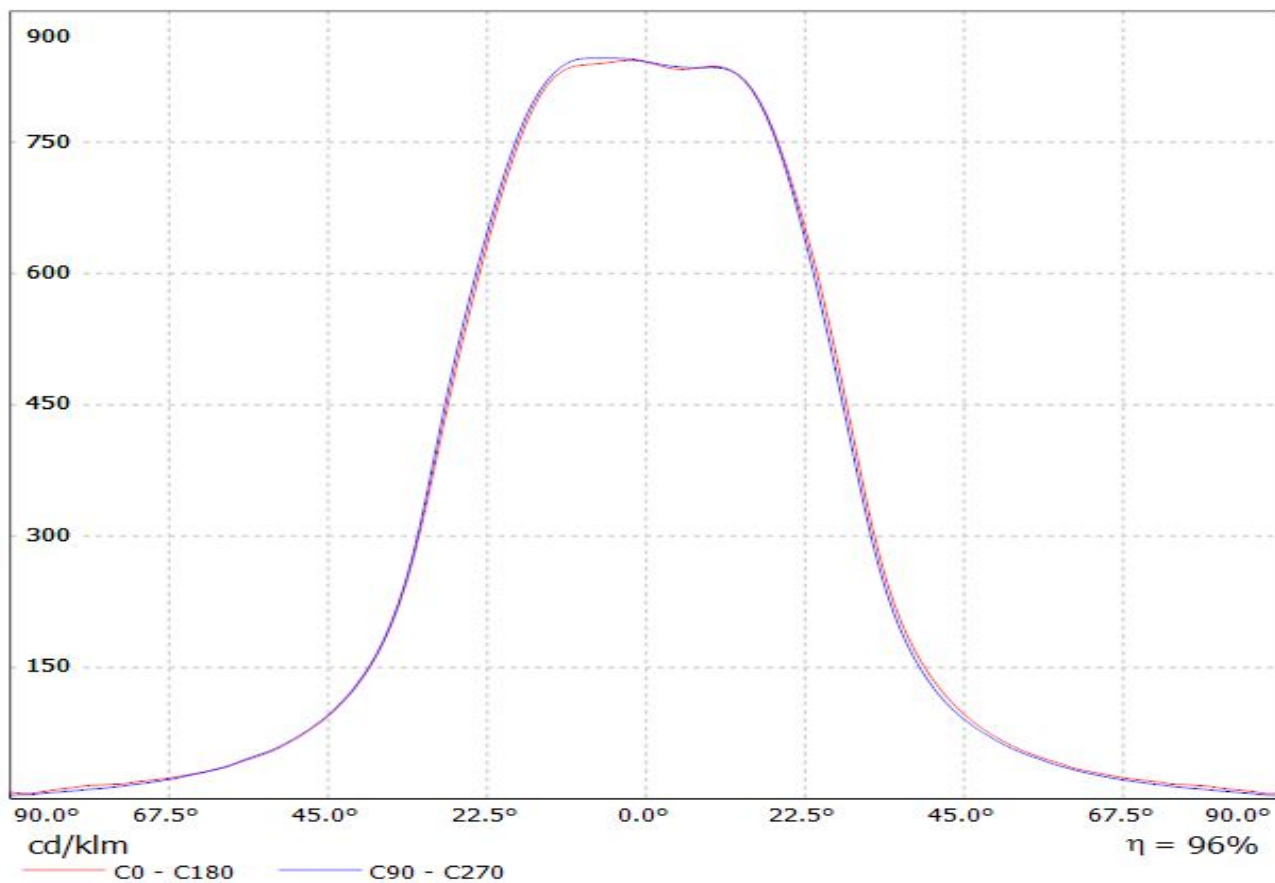

Luminaire: LEDiL Oy CS14130_HB-IP-2X6-W_(XM-L2) Eff.94.0%
Lamps: 1 x CREE_XM-L2_2x6_1197.78lm@250mA_P=8.38555W_I=254.1mA

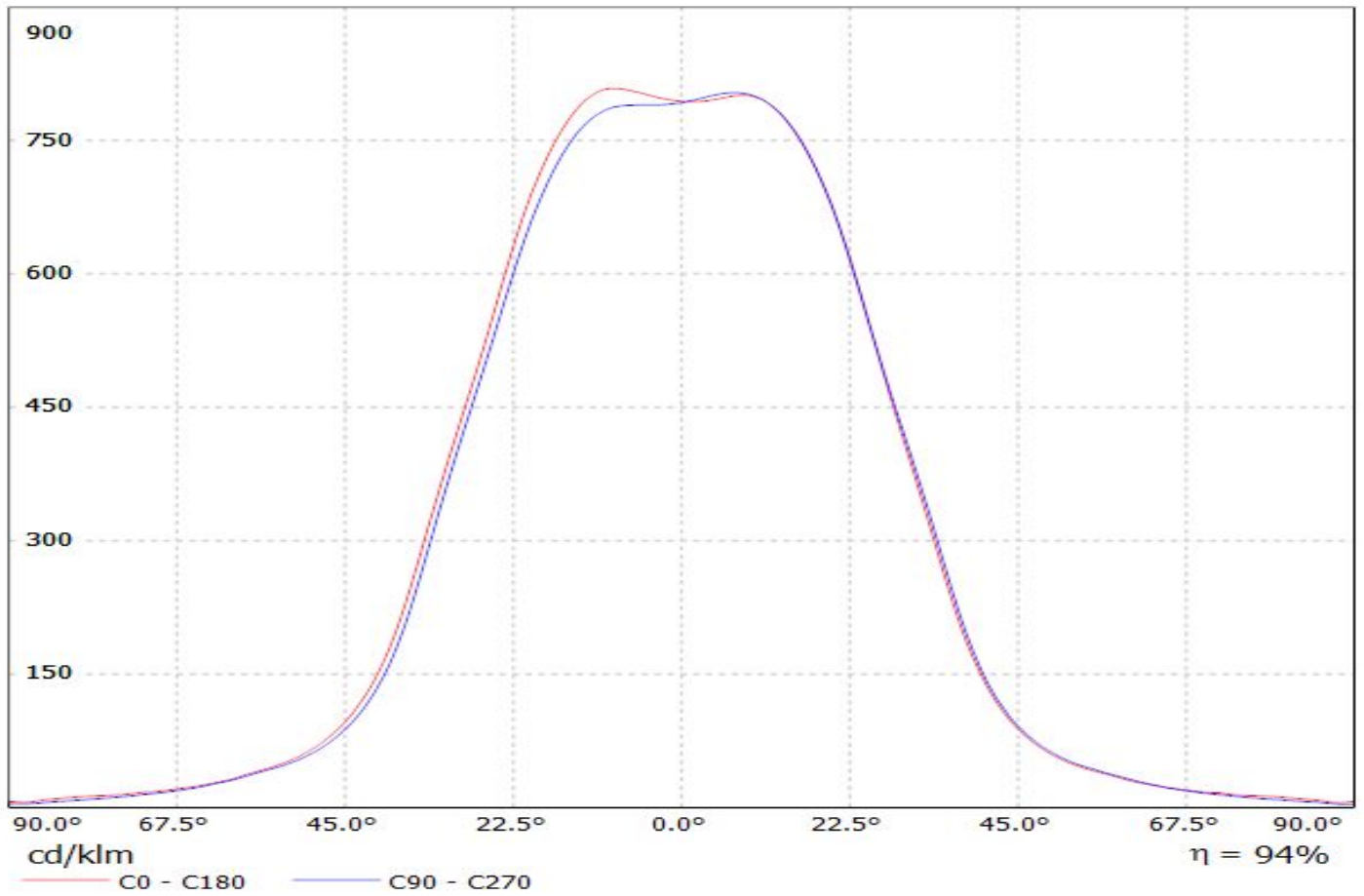

Luminaire: LEDiL Oy CS14130_HB-IP-2X6-W_(XP-G2) Eff.93.2%
Lamps: 1 x CREE_XP-G2_1303lm@250mA_P=8.58363W_I=249.8mA

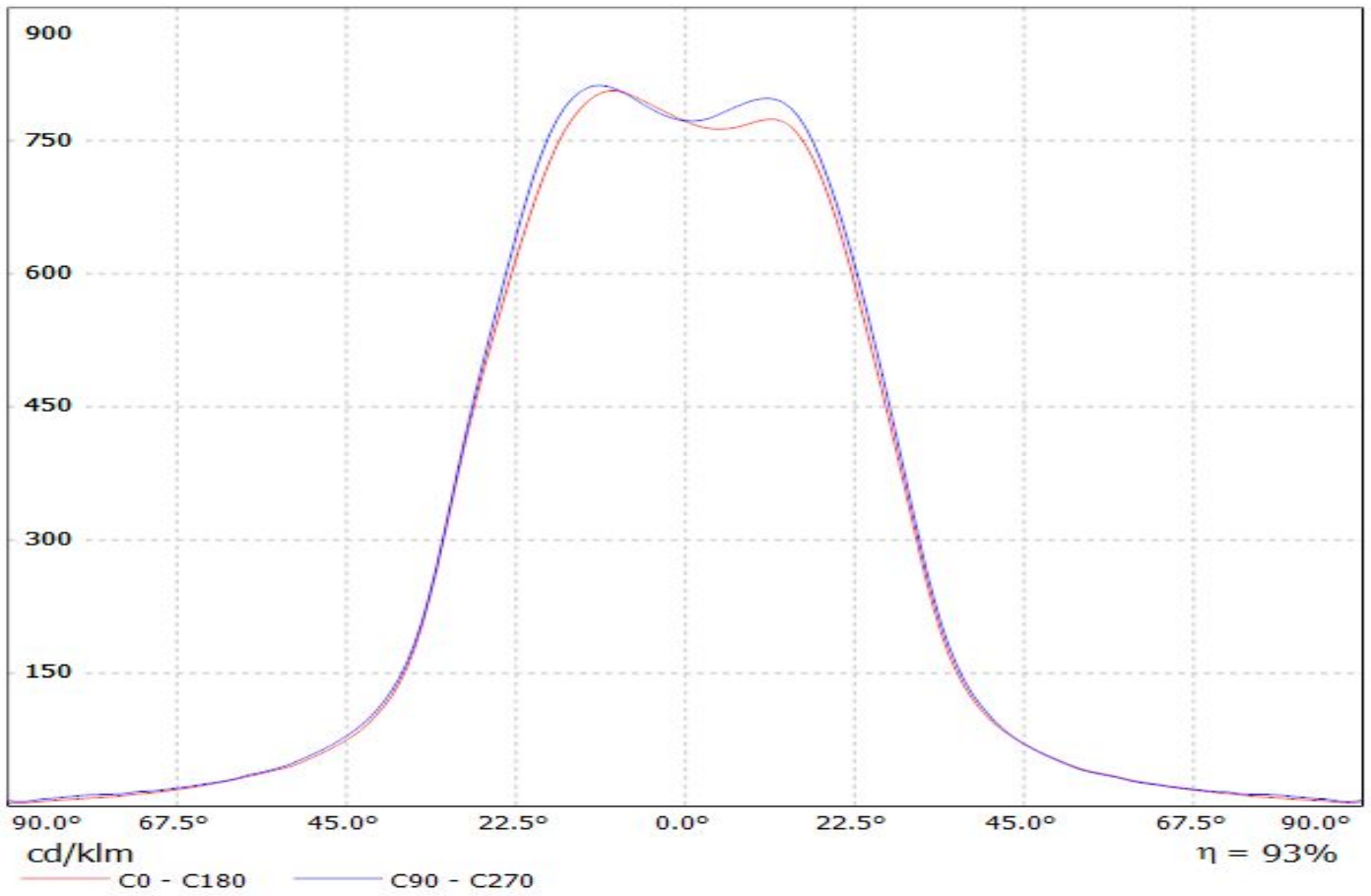

Luminaire: LEDiL Oy CS14130_HB-IP-2X6-W_(XP-G) Eff 94.0%
Lamps: 1 x CREE_XP-G_6x2_799.2lm@250mA_P=8.52542W_I=249.8mA

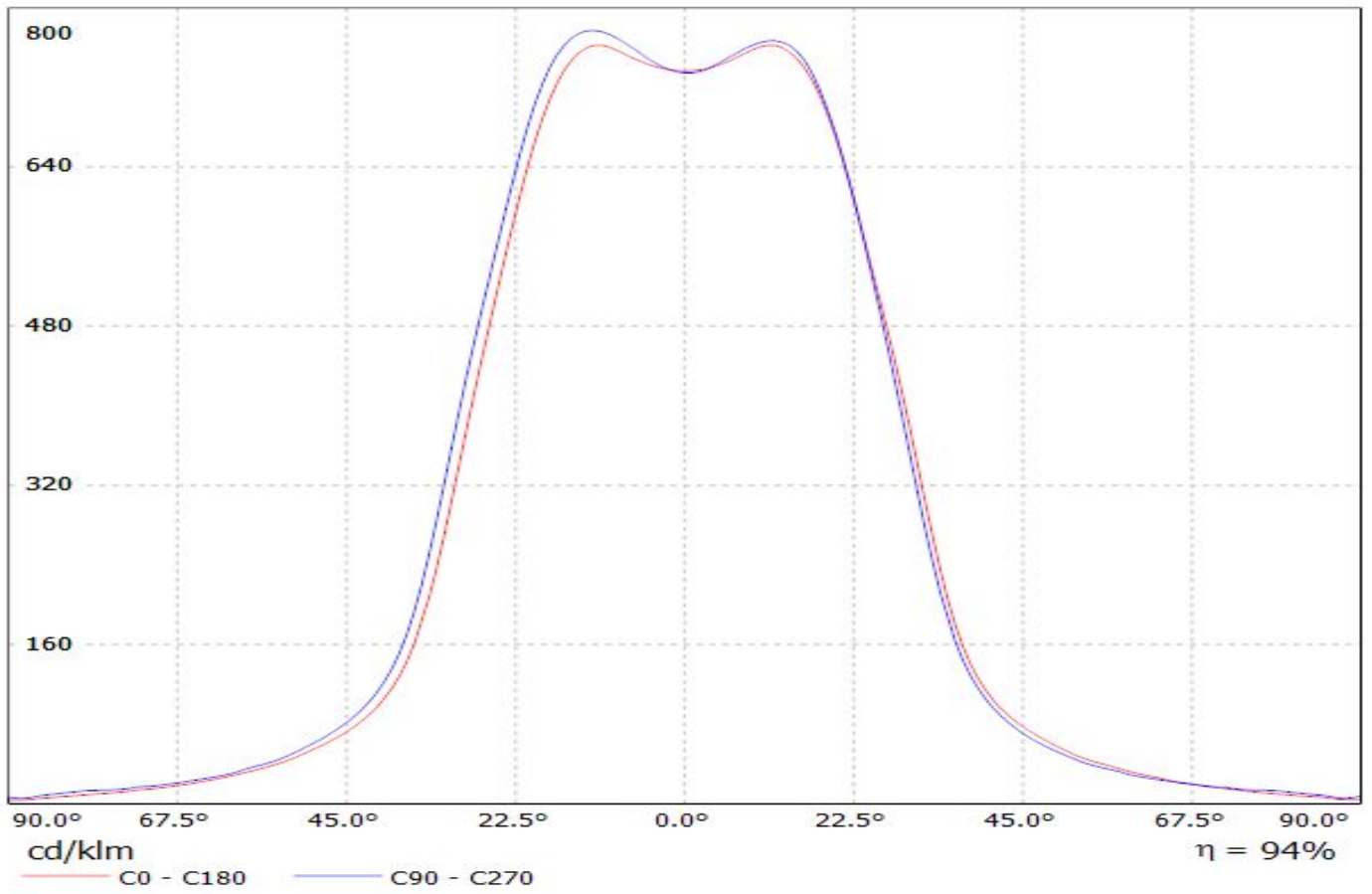

Luminaire: LEDiL Oy CS14130_HB-IP-2X6-W_(XP-L)

Lamps: 1 x CREE_XP-L_2x6_(XPLAWT-0-7A3-U50-0H-0001)_1253.88lm@250mA_P=8.22317W_I=249.8mA

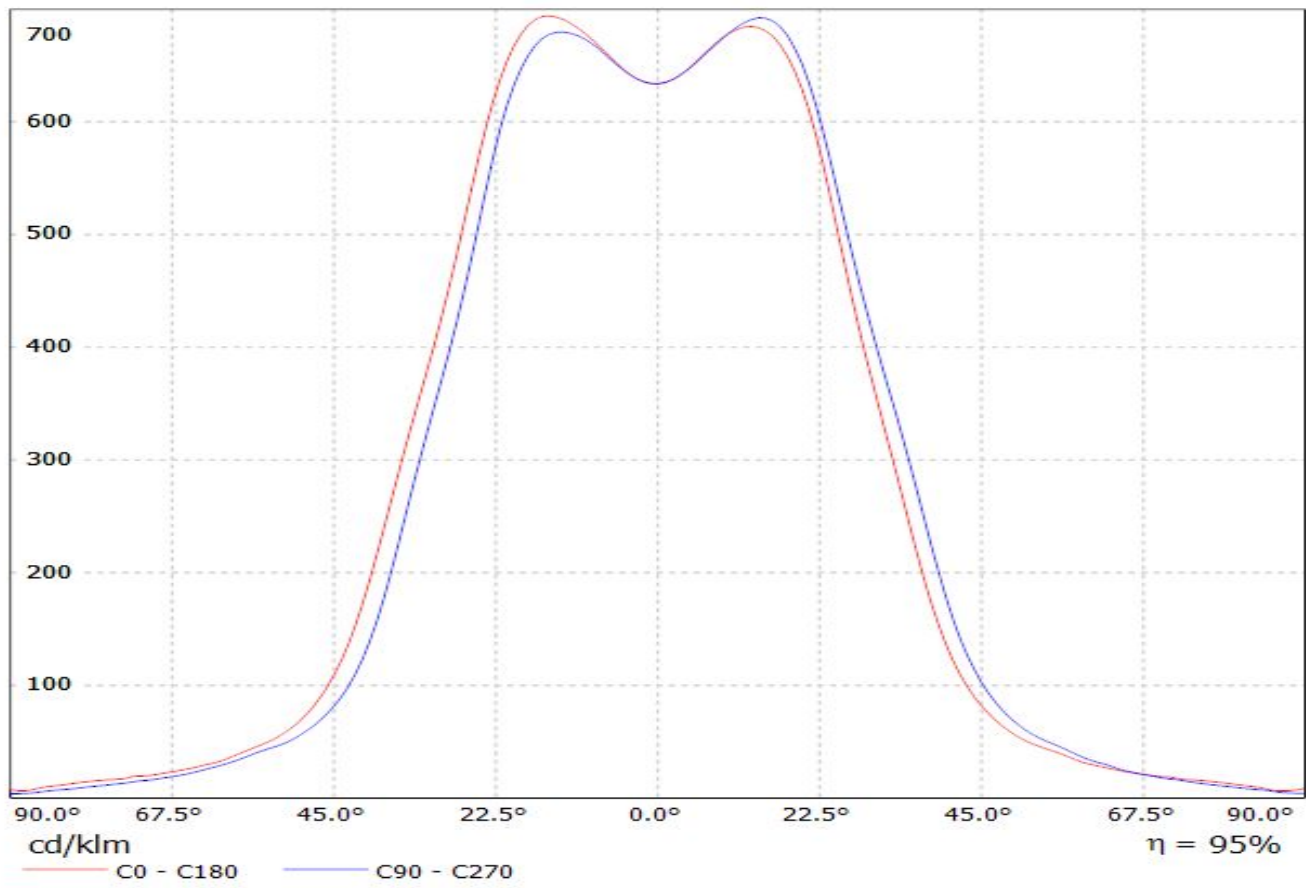

Luminaire: Ledil CS14130_HB-IP-2X6-W_(XP-G3)

Lamps: 1 x Cree_XP-G3_6x2_(XPGDWT-B1-6C1-S3-0-01)_1521.26lm@250mA_P=8.253W_I=0.25A

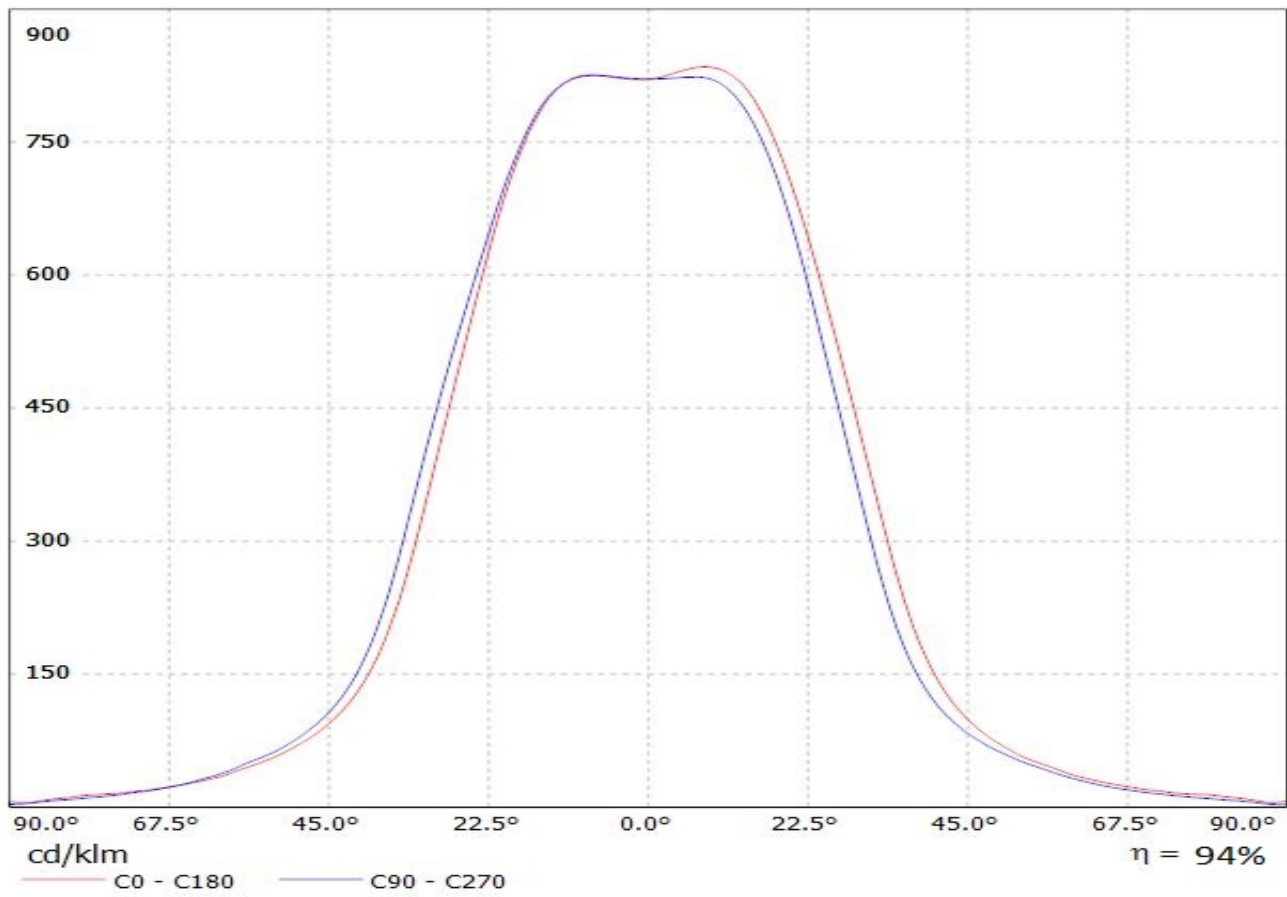

Luminaire: Ledil Oy CS14130_HB-IP-2X6-W-MH-B_SIMULATED
Lamps: 1 x Cree MH-B

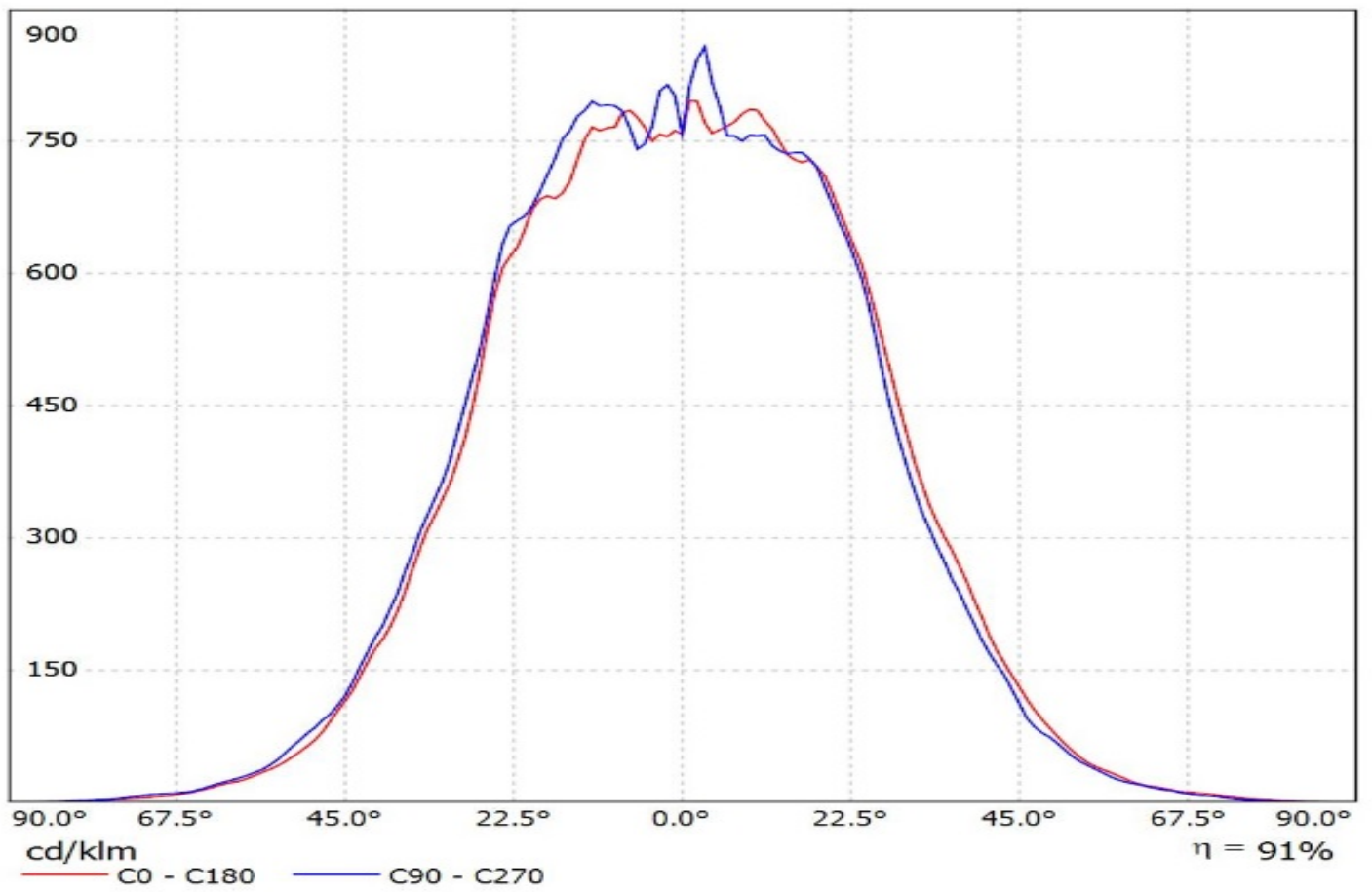

Luminaire: Ledil CS14130_HB-IP-2X6-W_(XP-L2)
Lamps: 1 x Cree_XP-L2_2x6_1659.4lm@250mA_P=8.22525W_I=0.25A

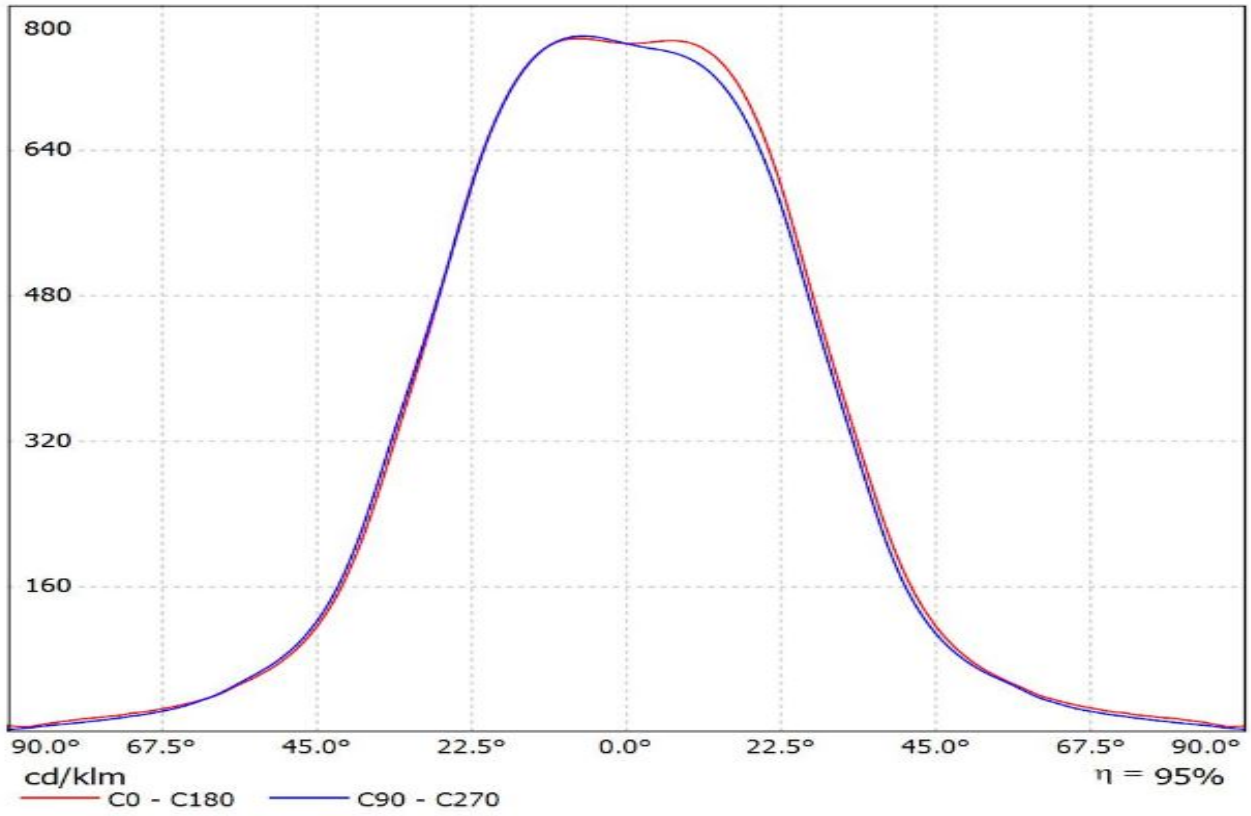

Luminaire: Ledil Oy CS14130_HB-IP-2X6-W_(H35C1)_SIMULATED
Lamps: 1 x LG H35C1

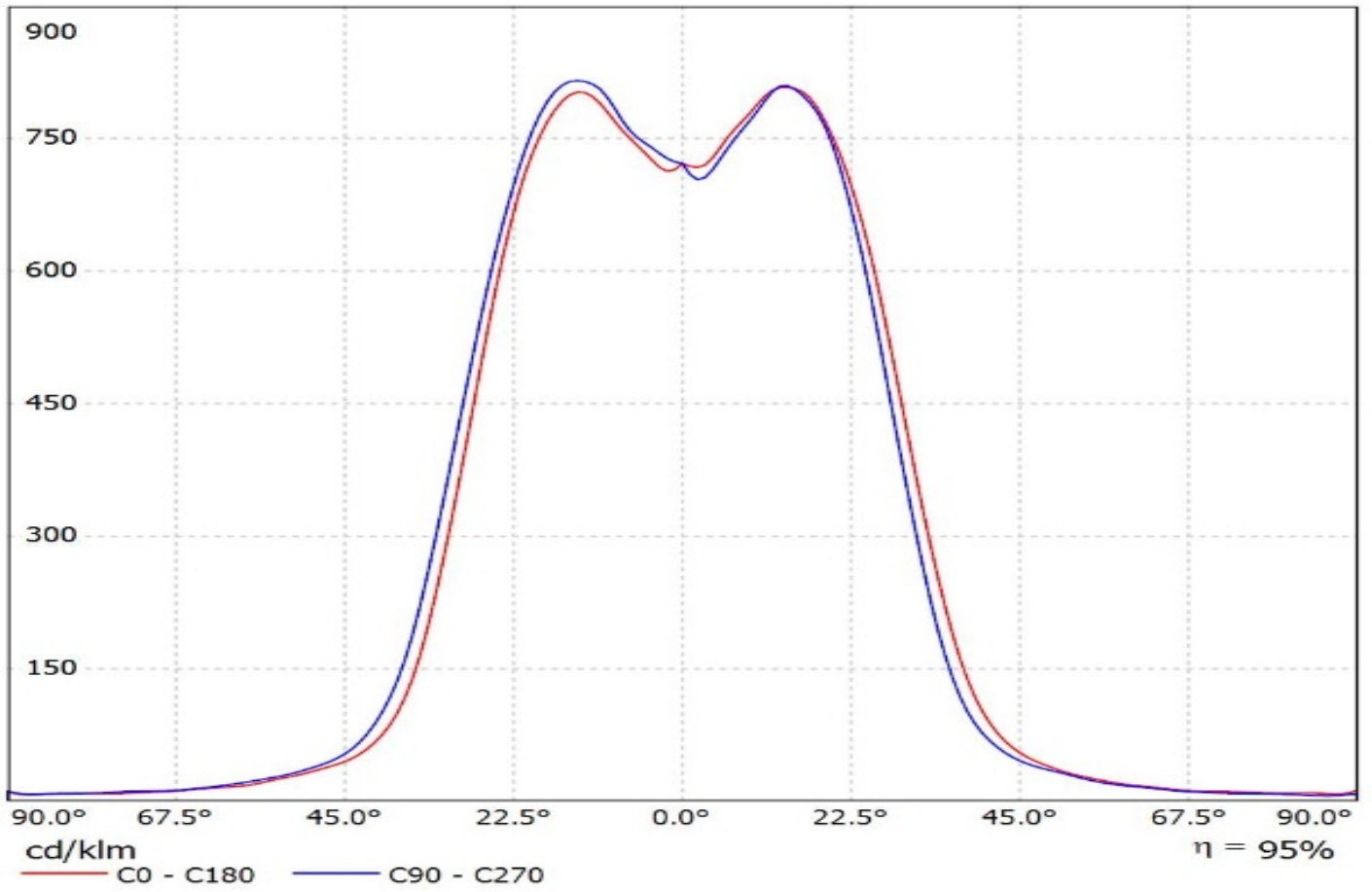

Luminaire: LEDiL Oy CS14130_HB-IP-2X6-W_(LUXEON_T) Eff.94.0%
Lamps: 1 x LUXEON_T_6x2_(LXH8-FW30)_1062.6lm@250mA_P=8.46572W_I=249.8mA

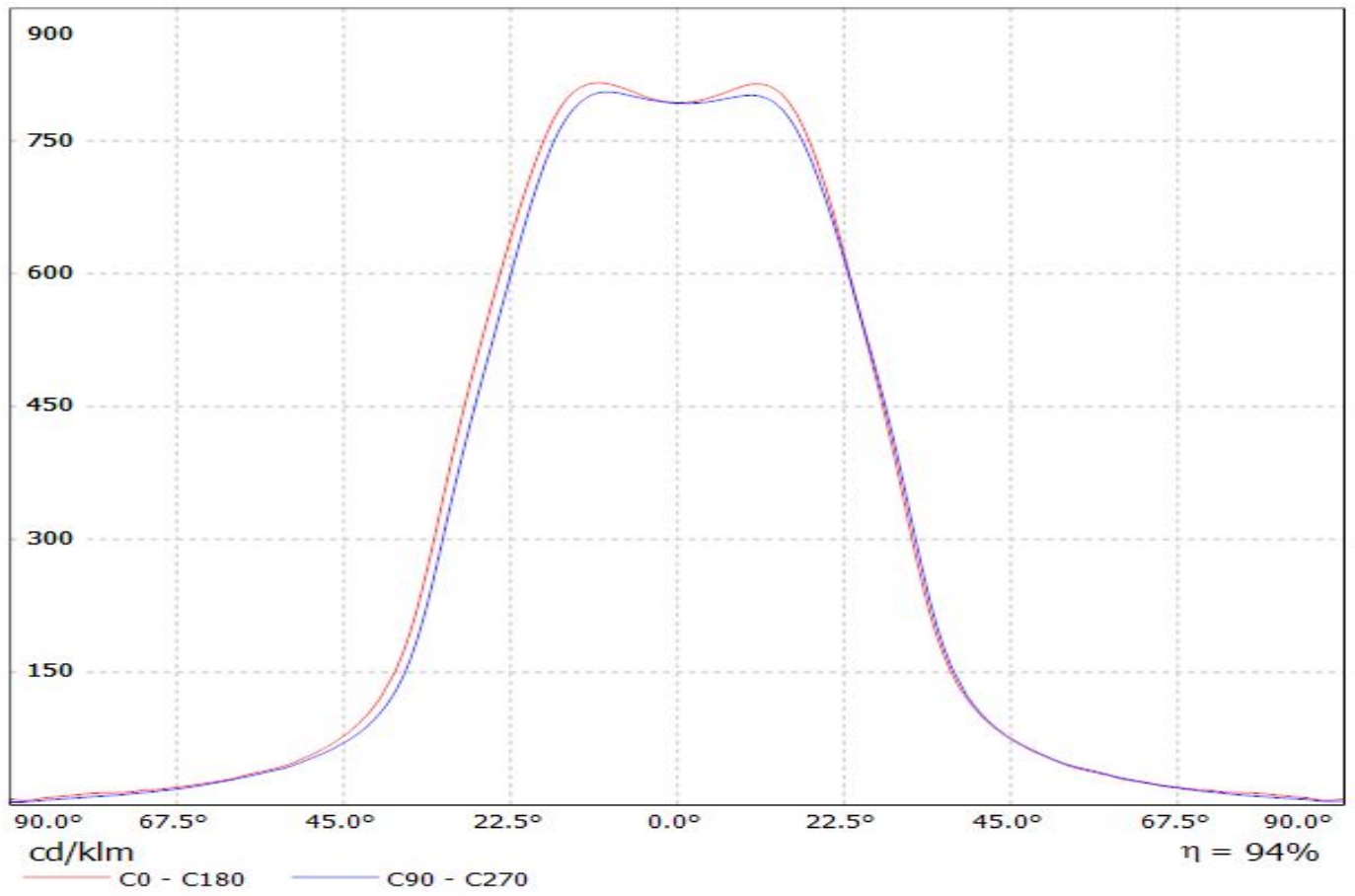

Luminaire: LEDiL Oy CS14130_HB-IP-2X6-W_(REBEL-ES) Eff.94.0%
Lamps: 1 x Luxeon_Rebel-ES_2x6_864.2lm@250mA_P=9.03127W_I=249.8mA

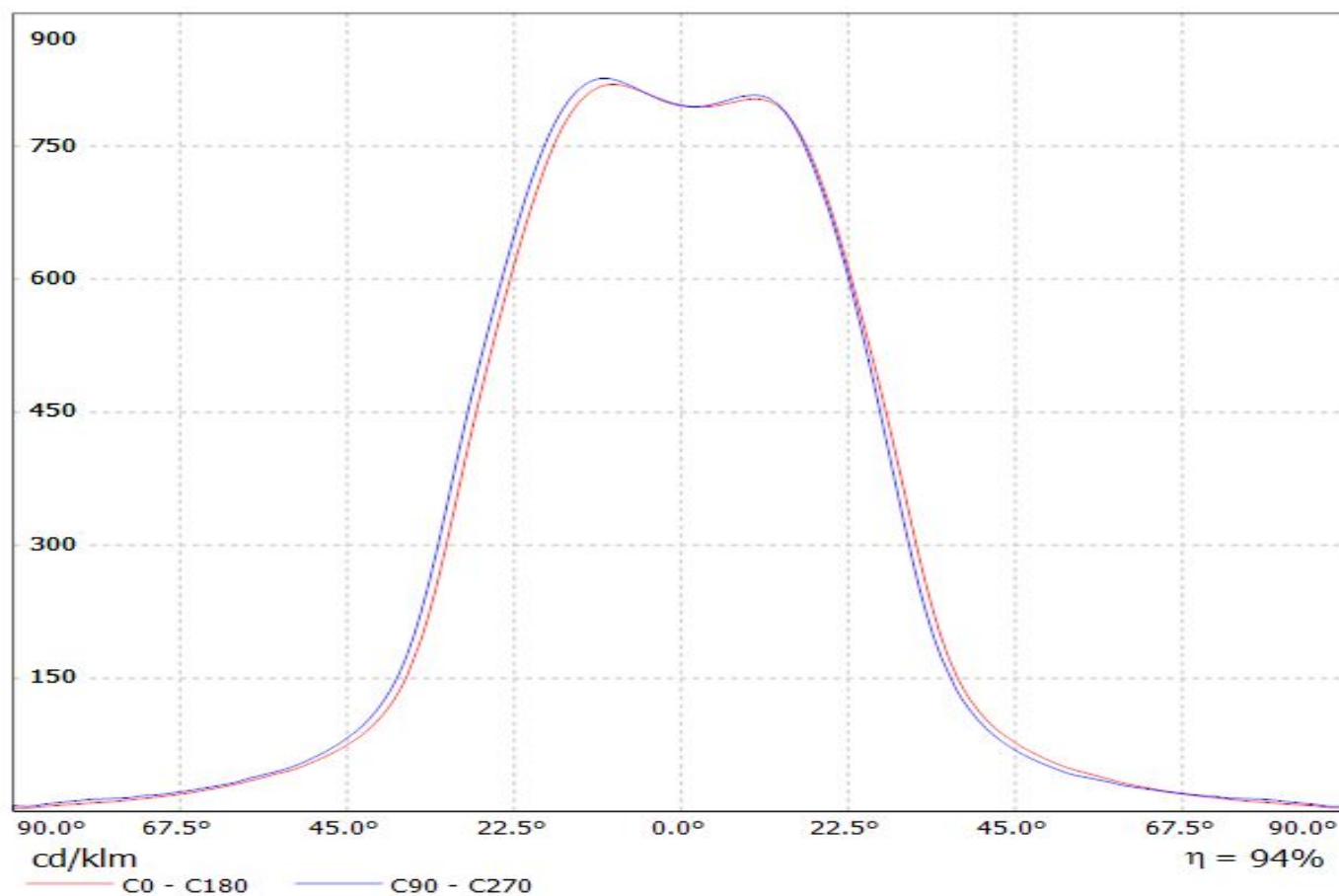

Luminaire: LEDiL Oy CS14130_HB-IP-2X6-W_(LUXEON-R) Eff 94.0%
Lamps: 1 x Luxeon_R_6x2_1154lm@250mA_P=8.29161W_I=249.8mA

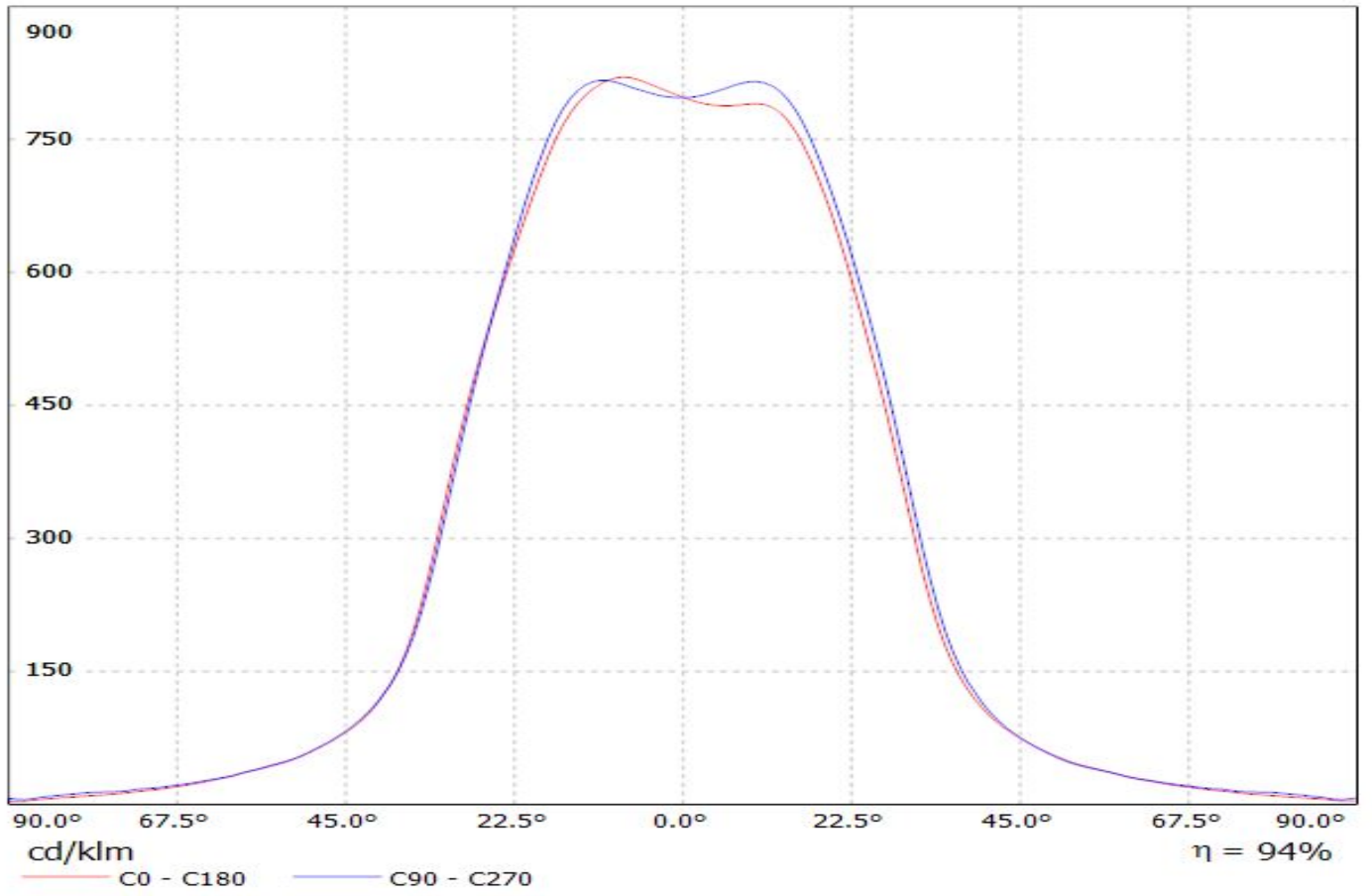

Luminaire: LEDiL Oy CS14130_HB-IP-2X6-W_(LUXEON_Z_ES) Eff.94.0%
Lamps: 1 x LUXEON_Z_ES_990.2lm@250mA_P=8.31159W_I=249.8mA

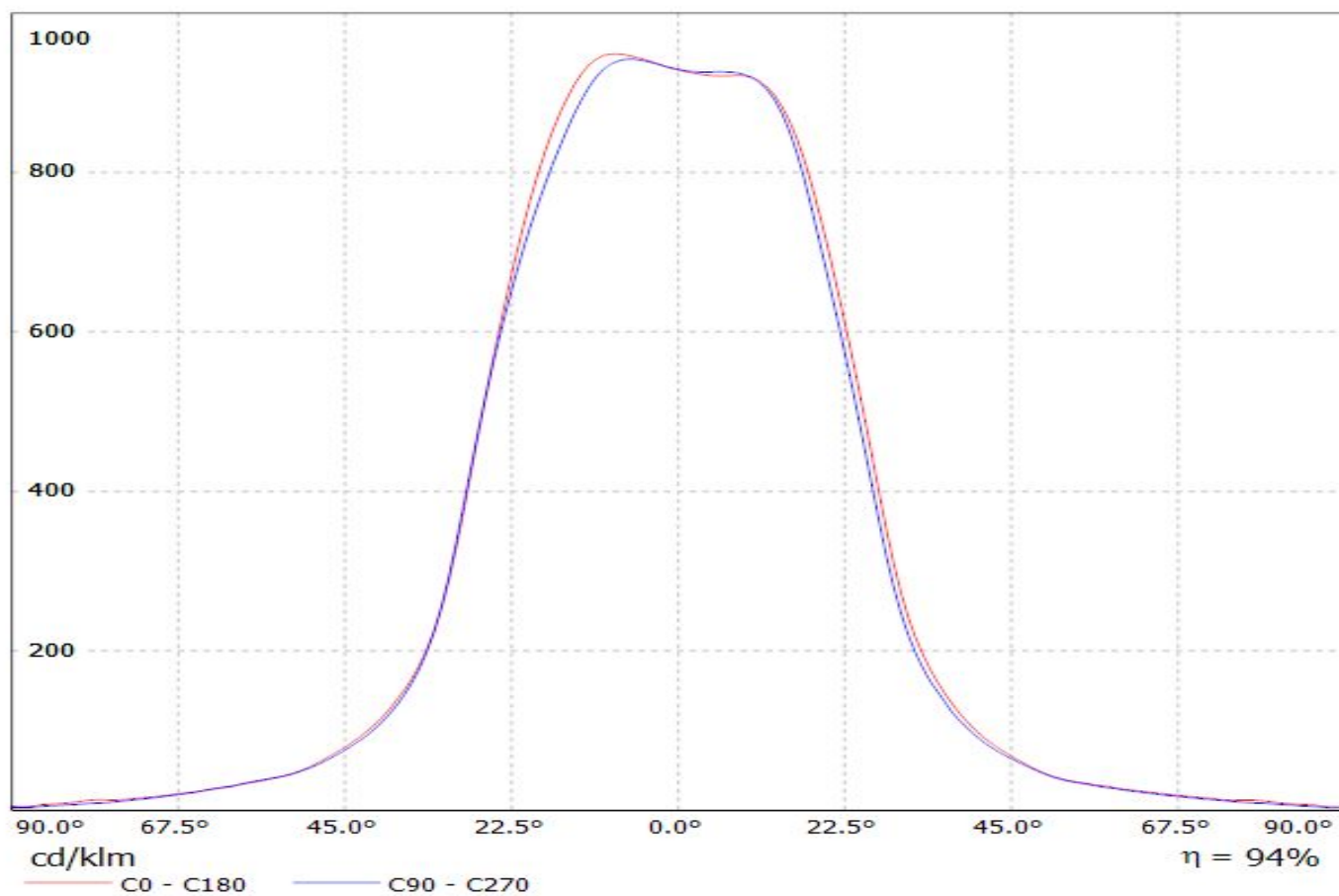

Luminaire: LEDiL Oy CS14130_HB-IP-2X6-W_(Luxeon_TX)
Lamps: 1 x Luxeon_TX_2x6_1301.4lm@250mA_P=8.26138W_I=249.8mA

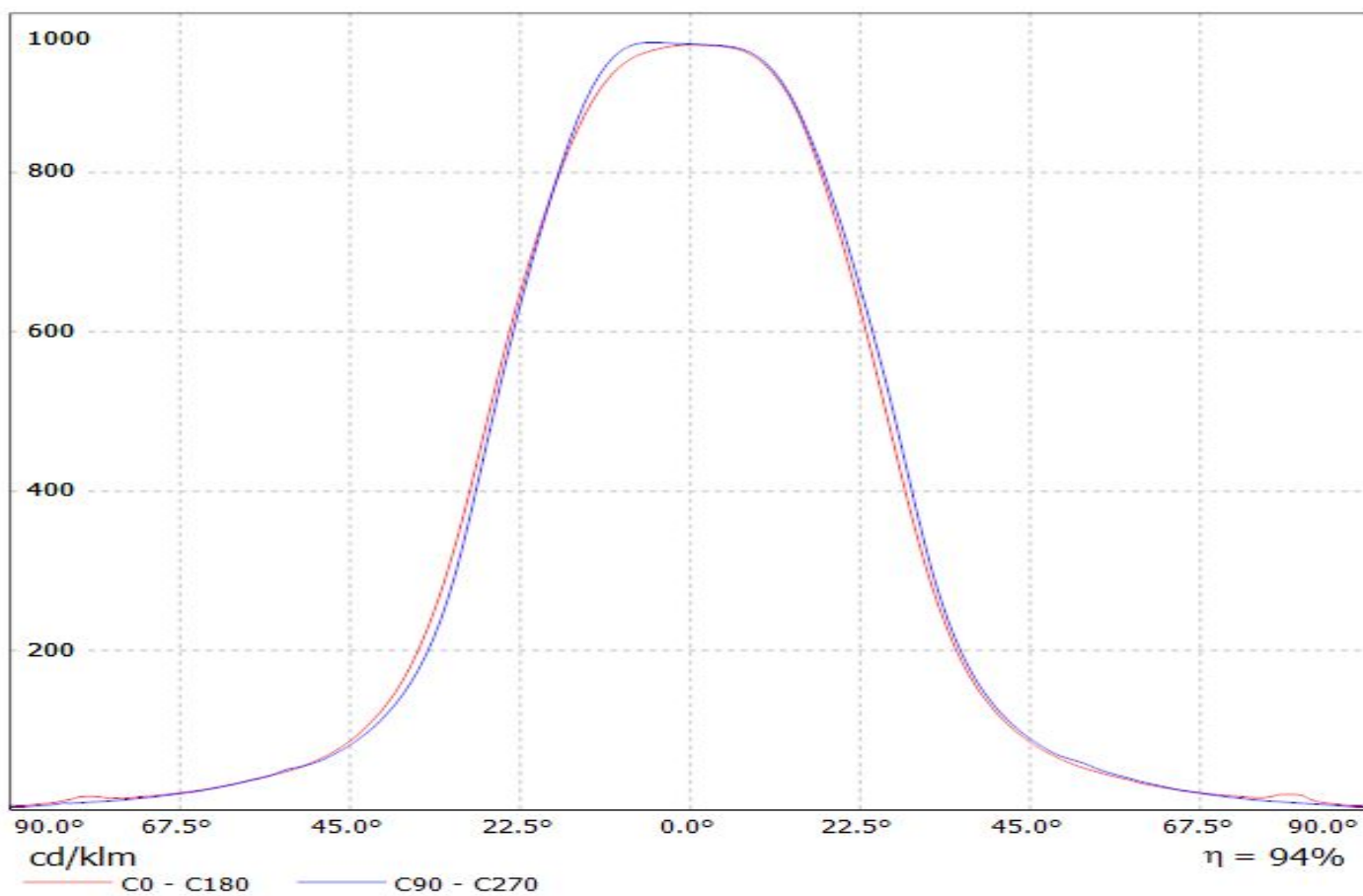

Luminaire: Ledil CS14130_HB-IP-2X6-W_(XR-TX)

Lamps: 1 x Luxeon_XR-TX_1376.41lm@250mA_P=8.3920W_I=0.250A

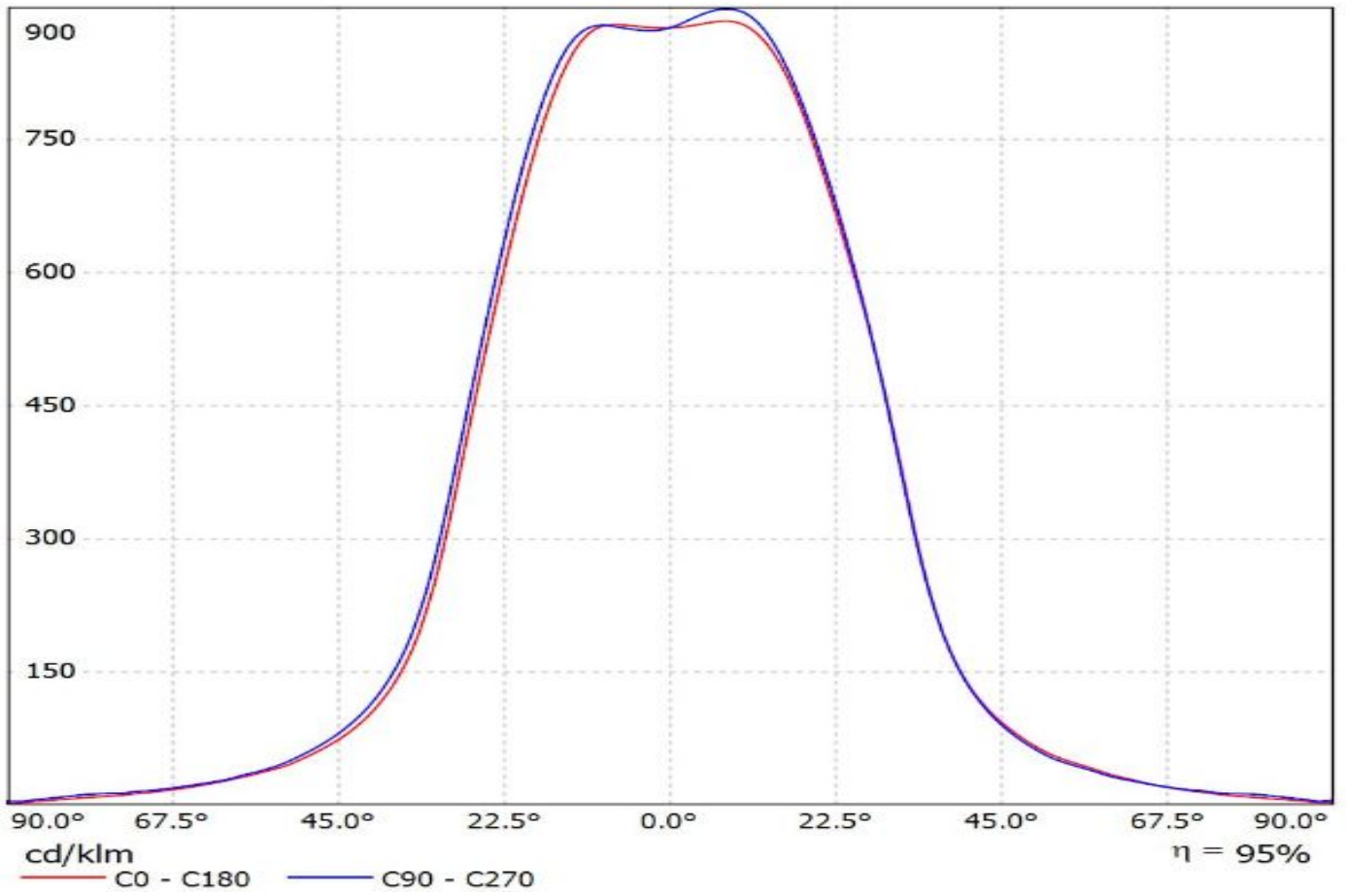

Luminaire: Ledil CS14130_HB-IP-2X6-W_(NVSL219CT)
Lamps: 1 x Nichia_NVSL219CT_2x6_1262.53lm@250mA_P=8.35825W_I=0.25A

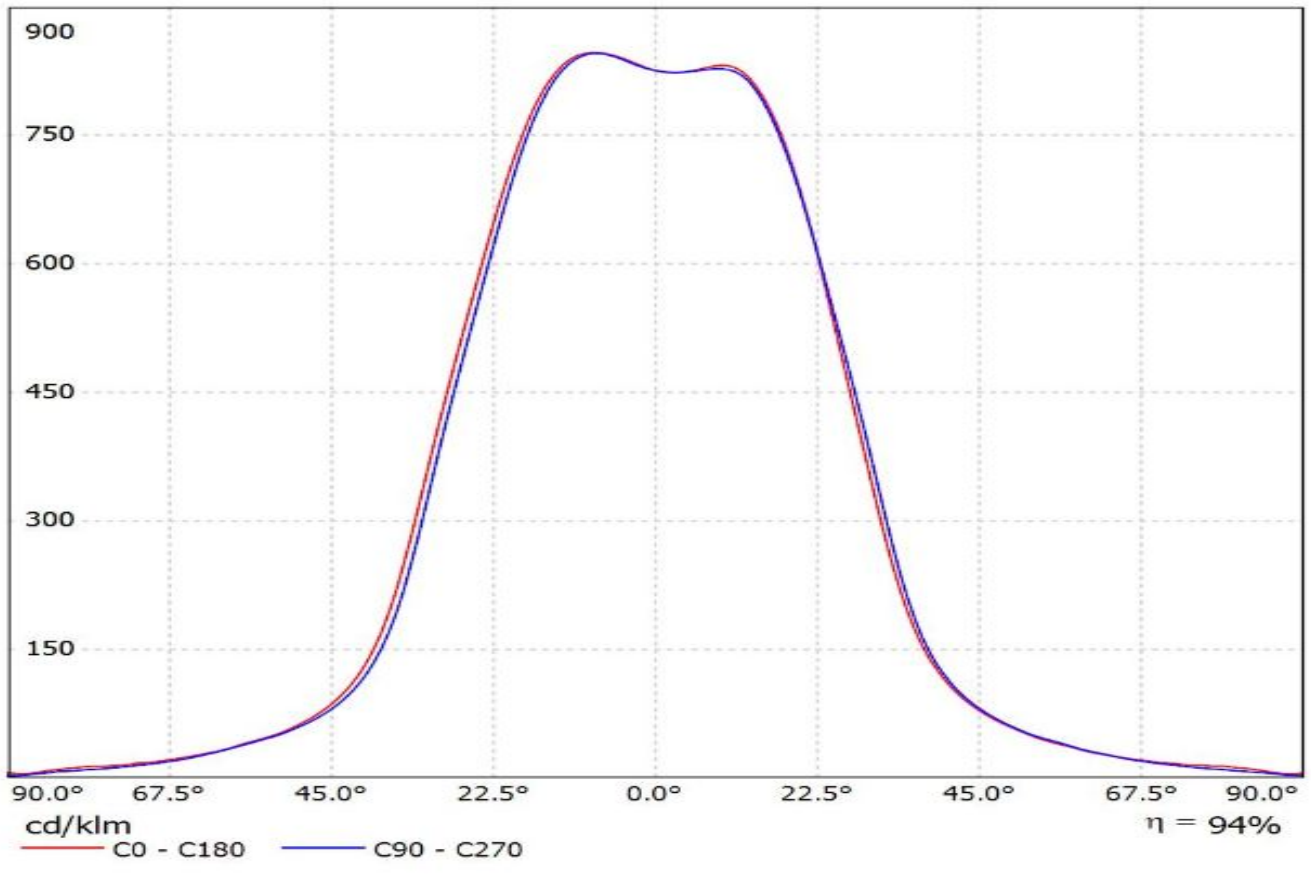

Luminaire: LEDiL Oy CS14130_HB-IP-2X6-W_(Nichia_E21)
Lamps: 1 x Nichia_NVSWE21A_583.232lm@600mA_P=3.51742W_I=0.600A

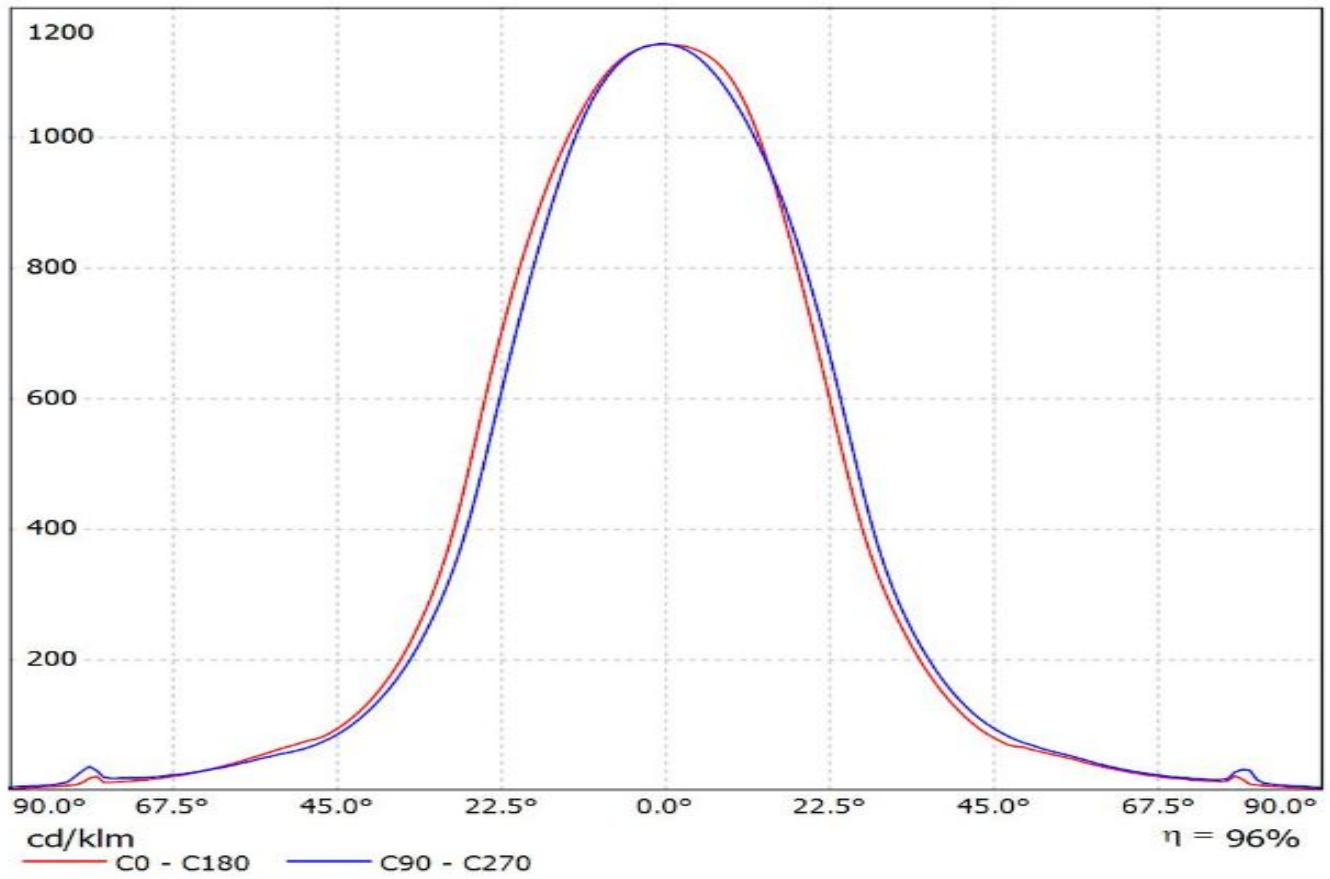

Luminaire: Ledil Oy CS14130_HB-IP-2X6-W-DURIS-S8_SIMULATED
Lamps: 1 x DURIS-S8

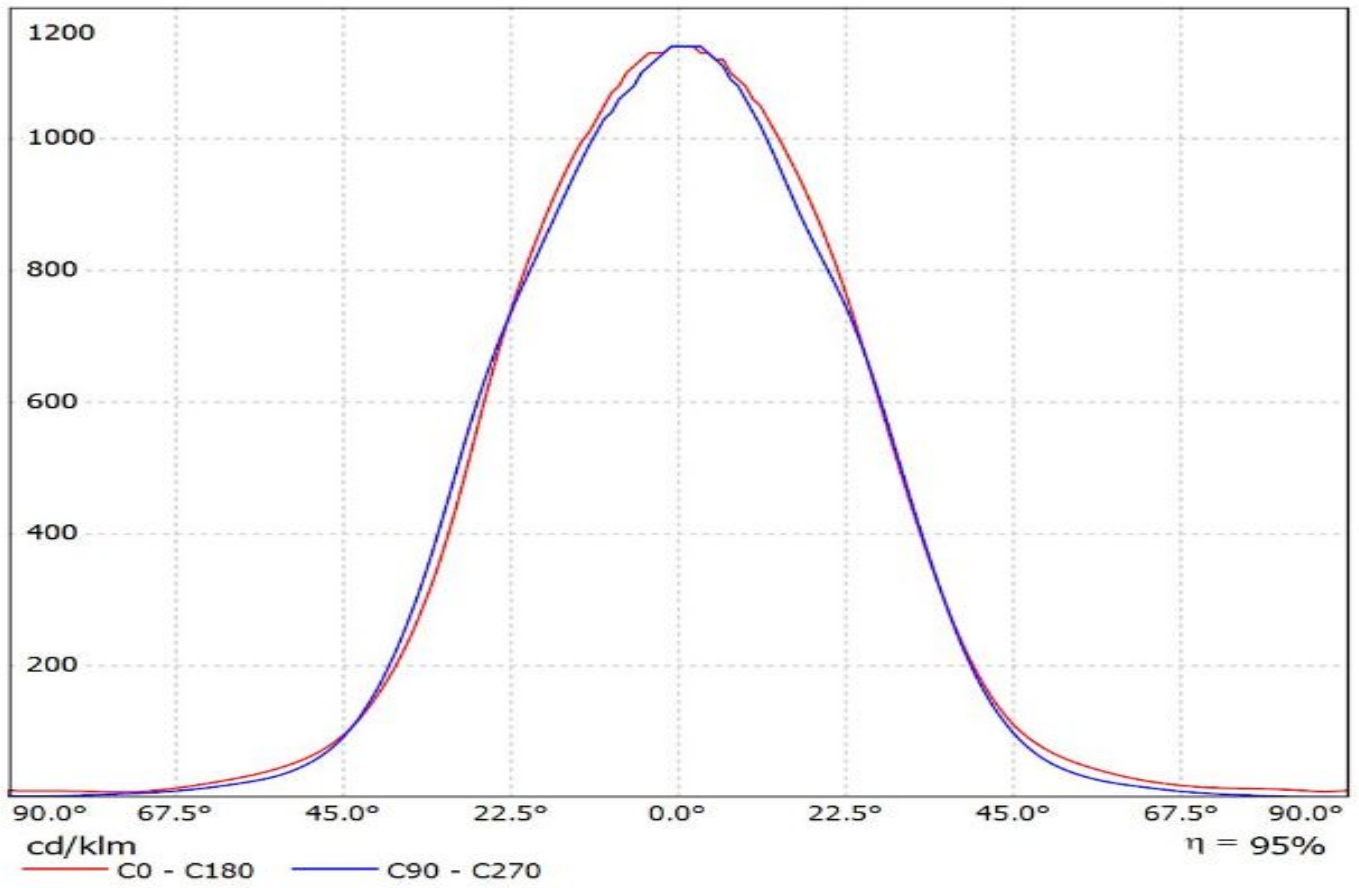

Luminaire: LEDiL Oy CS14130_HB-IP-2X6-W_(Z5M1) Eff.94.0%
Lamps: 1 x SEOUL_Z5M1_2x6_(SZ5-M1-WW-C8)_1177.2lm@250mA_P=8.5619W_I=249.8mA

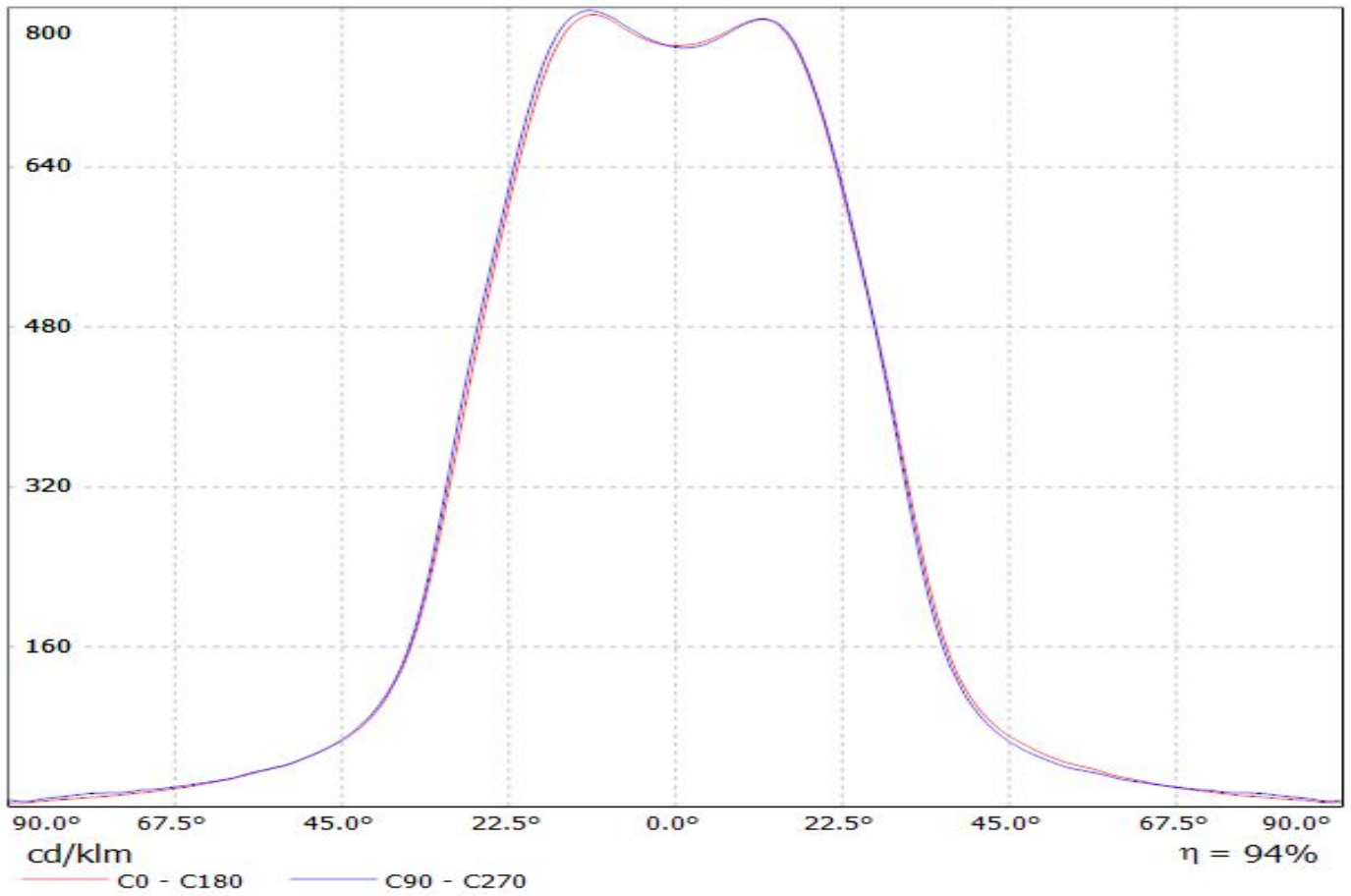

Luminaire: Ledil Oy CS14130_HB-IP-2X6-W_MJT4040_SIMULATED
Lamps: 1 x

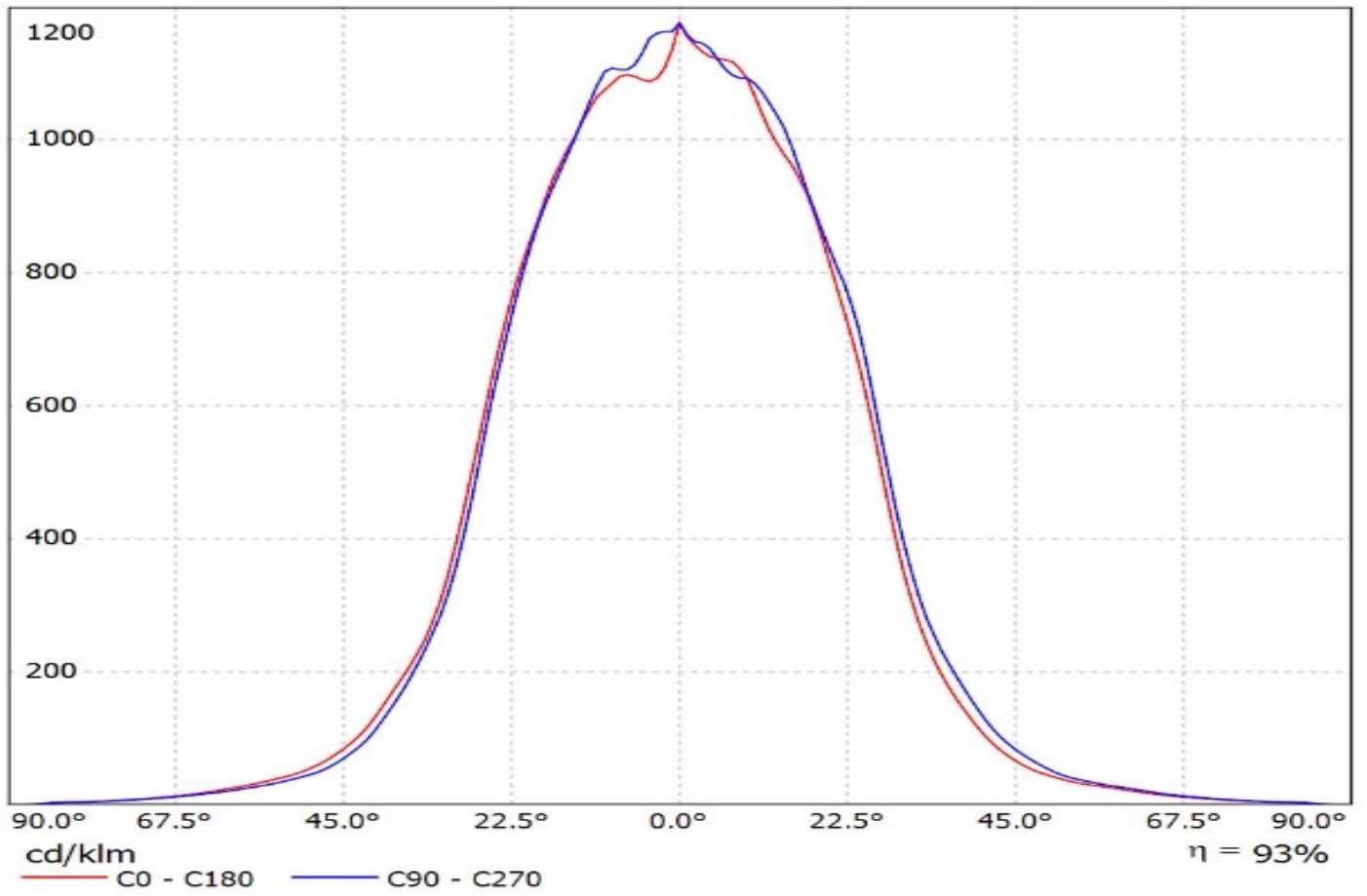

Ledil Oy CS14130HB-IP-2X6-W / LDC (Linear)

Luminaire: Ledil Oy CS14130HB-IP-2X6-W

Lamps: 1 x SEOUL_Z5M

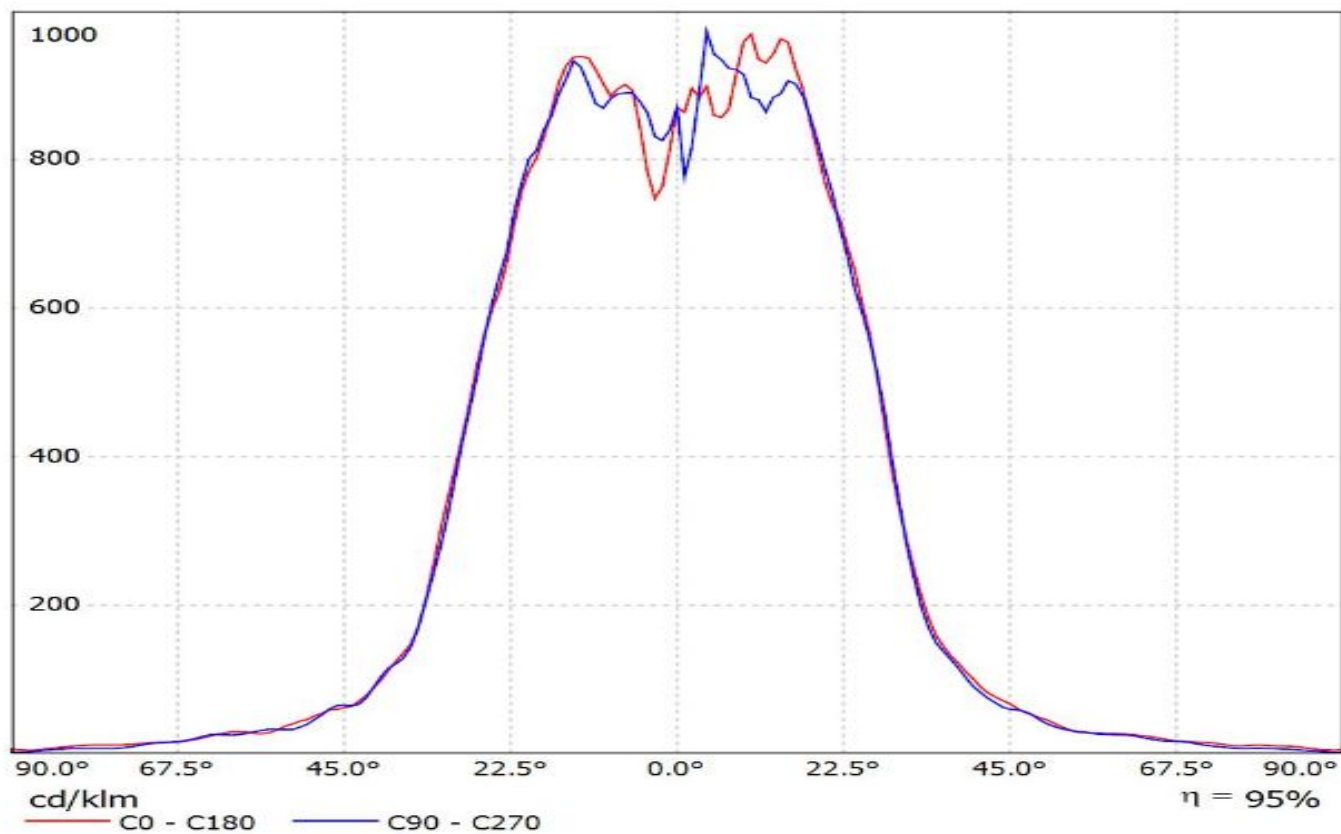

Luminaire: Ledil CS14130_HB-IP-2X6-W_(Z8Y22_PLUS)

Lamps: 1 x Seoul_Z8Y22_PLUS_2X6_(S28-Y22-W0-C7P)1489.65lm@250mA_P=8.30675W_I=0.250A

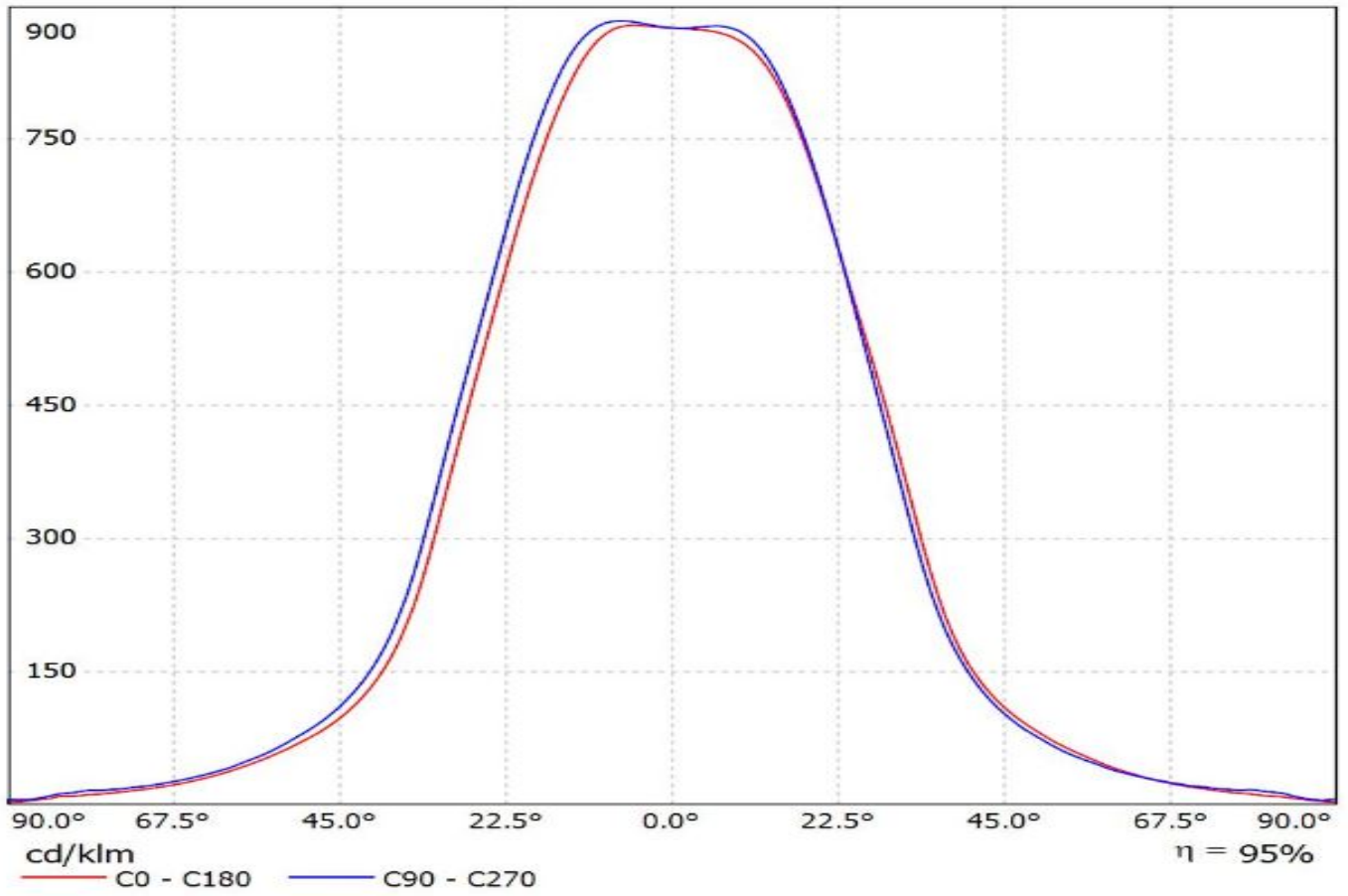

Ledil CS14130_HB-IP-2X6-W_(TL1L4) / LDC (Linear)

Luminaire: Ledil CS14130_HB-IP-2X6-W_(TL1L4)

Lamps: 1 x Toshiba_TL1L4_2x6_(TL1L4-DW0)_1263.19lm@250mA_CCT=6500K_P=8.5W_I=0.25A

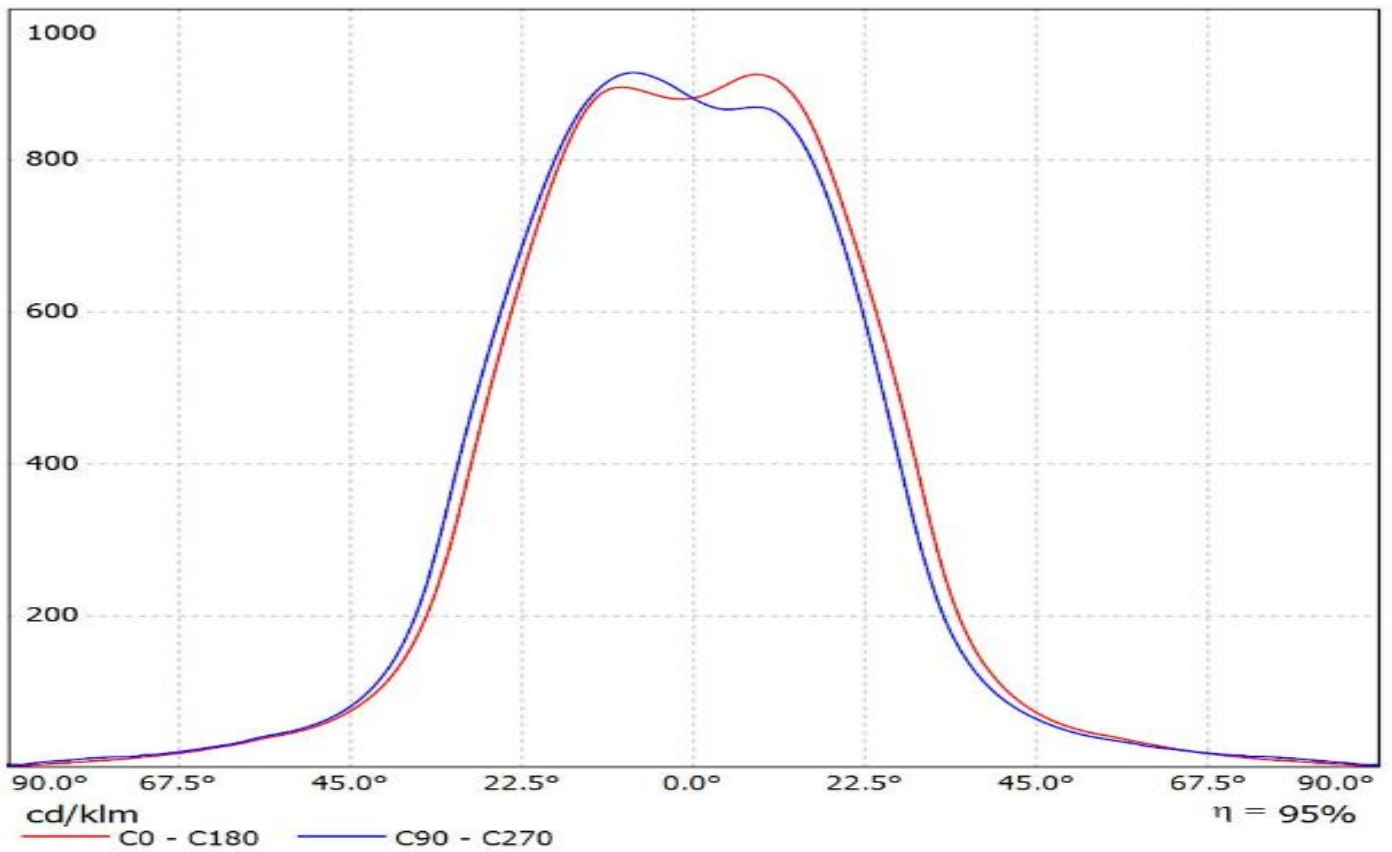

Luminaire: LEDiL Oy CS14130_HB-IP-2X6-W_(XT-E)

Lamps: 1 x CREE_XT-E_6x2_(XTEAWT-00-0000-000000HE4)_1253.92lm@250mA_P=8.86265W_I=249.8mA

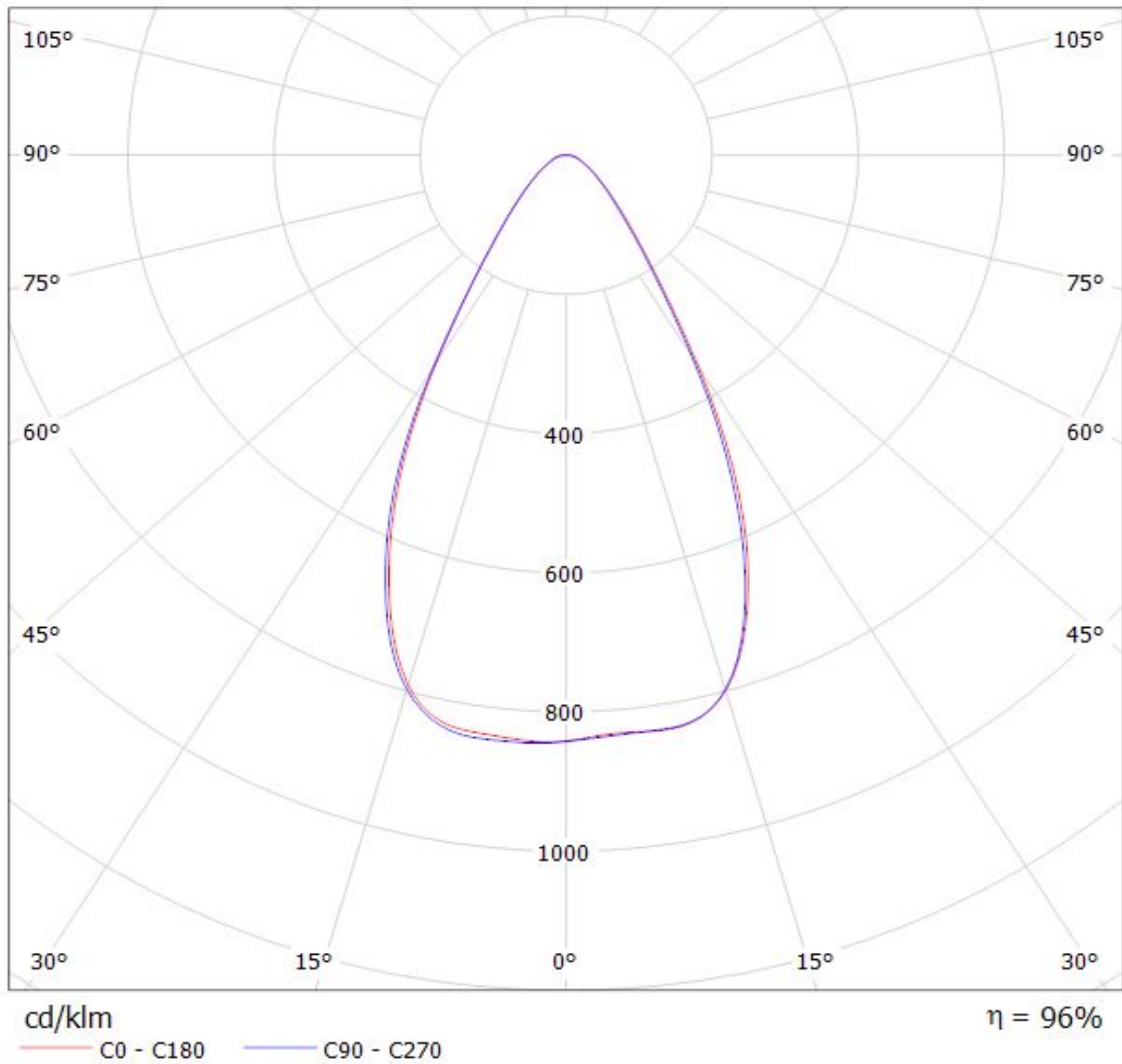

Luminaire: LEDiL Oy CS14130_HB-IP-2X6-W_(XM-L2) Eff.94.0%
Lamps: 1 x CREE_XM-L2_2x6_1197.78lm@250mA_P=8.38555W_I=254.1mA

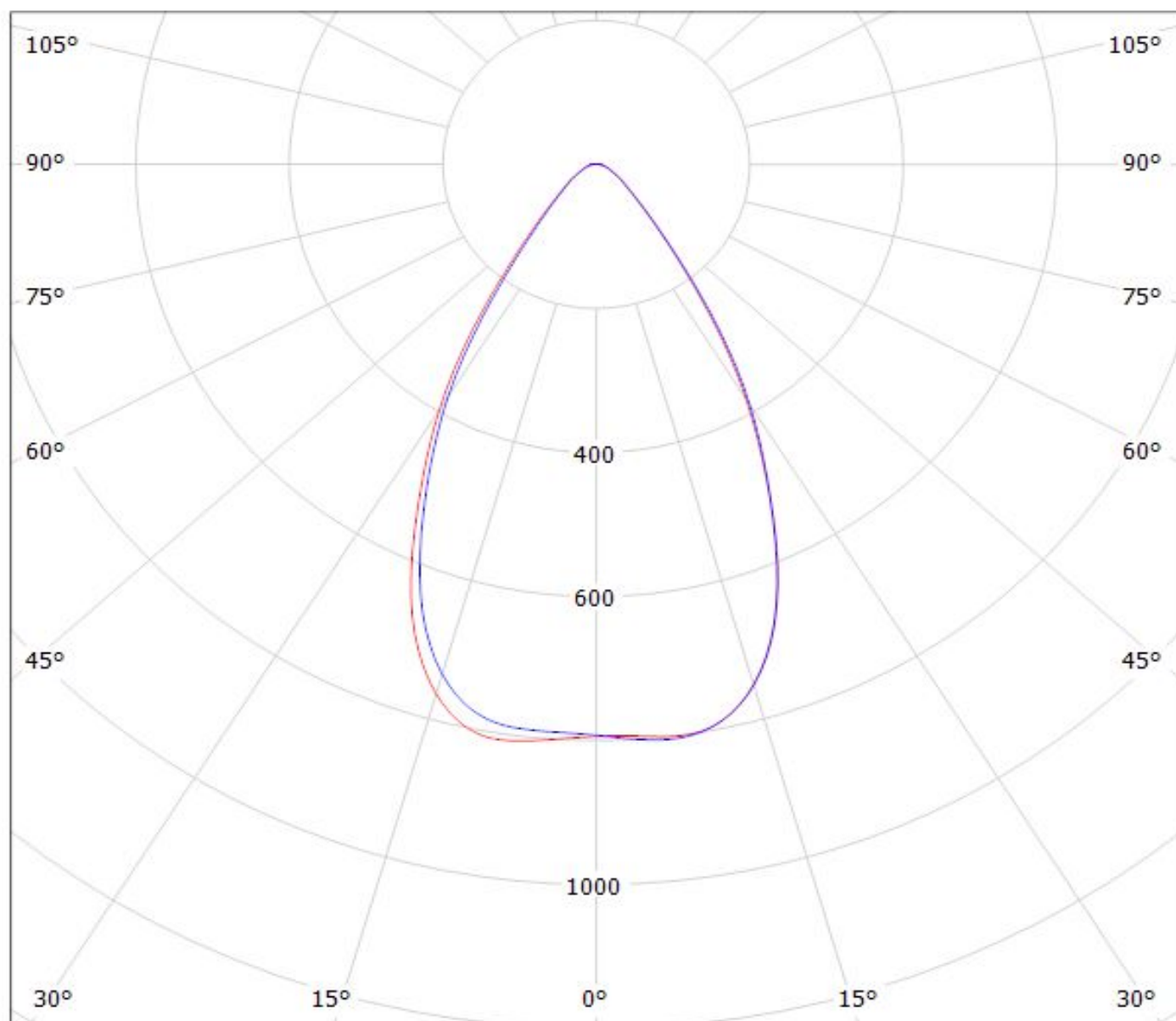

cd/klm

— C0 - C180 — C90 - C270

$\eta = 94\%$

Luminaire: LEDiL Oy CS14130_HB-IP-2X6-W_(XP-G2) Eff.93.2%
Lamps: 1 x CREE_XP-G2_1303lm@250mA_P=8.58363W_I=249.8mA

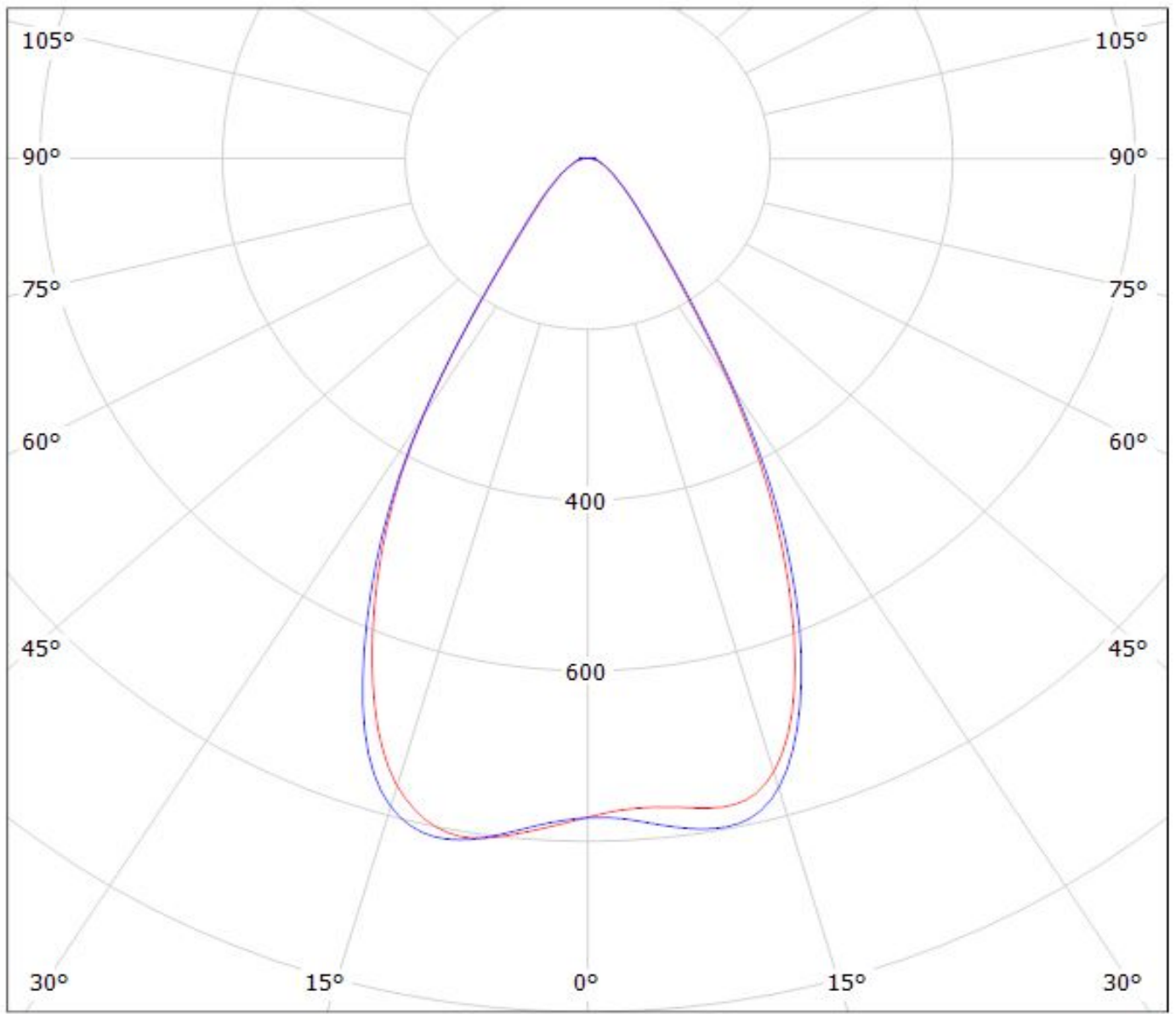

cd/klm
— C0 - C180 — C90 - C270

$\eta = 93\%$

Luminaire: LEDiL Oy CS14130_HB-IP-2X6-W_(XP-G) Eff.94.0%
Lamps: 1 x CREE_XP-G_6x2_799.2lm@250mA_P=8.52542W_I=249.8mA

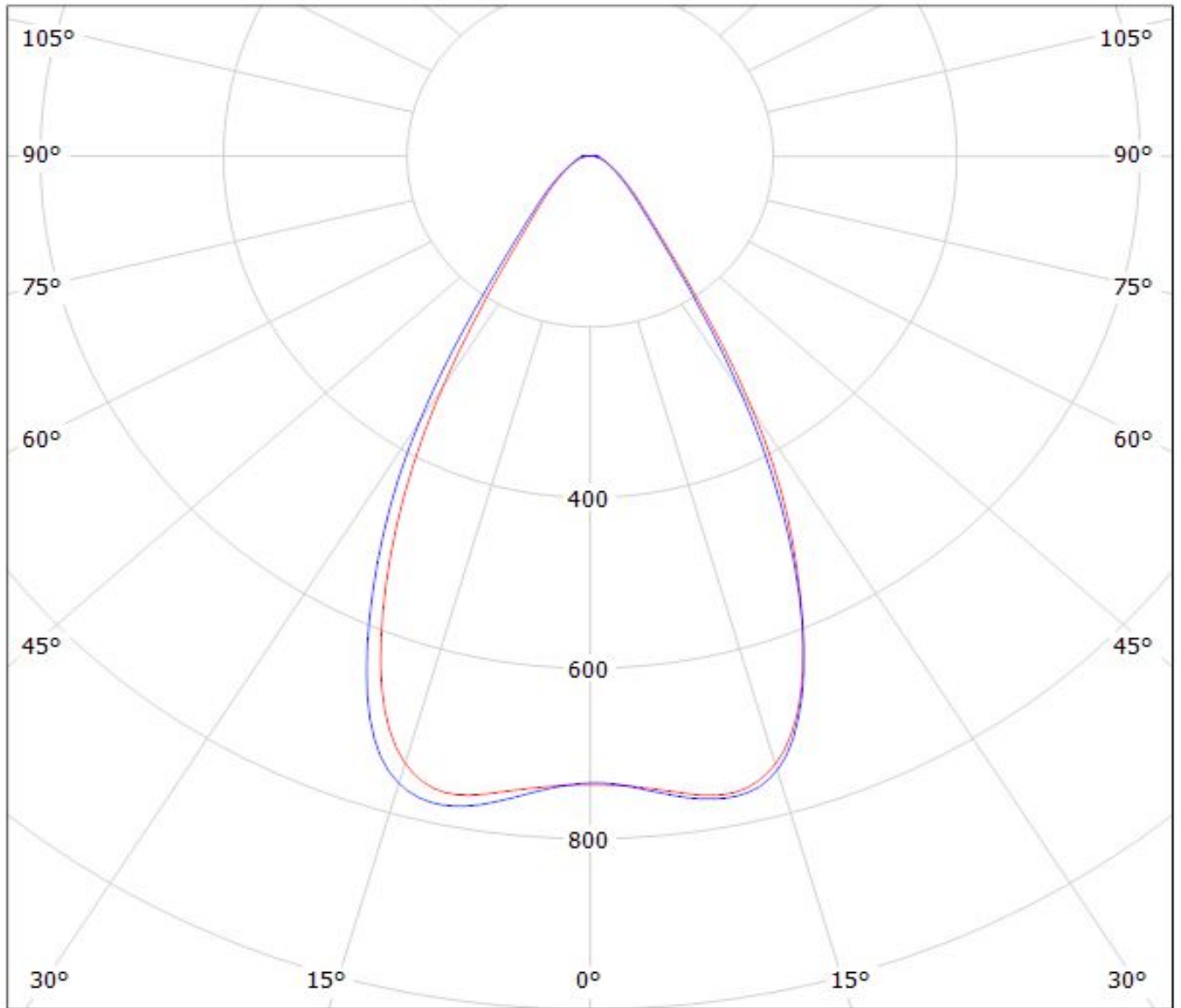

cd/klm

— C0 - C180 — C90 - C270

$\eta = 94\%$

Luminaire: LEDiL Oy CS14130_HB-IP-2X6-W_(XP-L)

Lamps: 1 x CREE_XP-L_2x6_(XPLAWT-0-7A3-U50-0H-0001)_1253.88lm@250mA_P=8.22317W_I=249.8mA

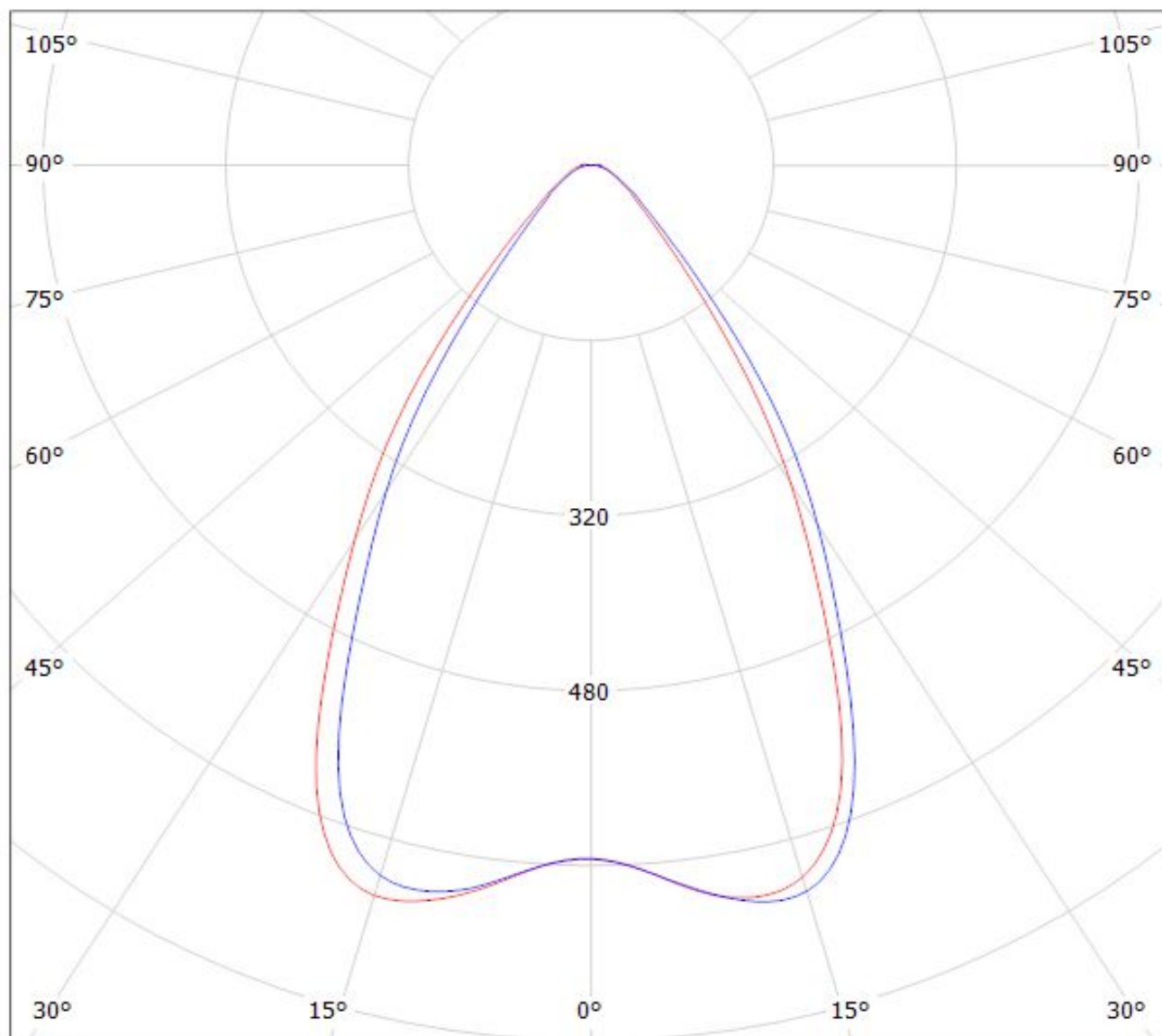

cd/klm

$\eta = 95\%$

— C0 - C180

— C90 - C270

Luminaire: Ledil CS14130_HB-IP-2X6-W_(XP-G3)

Lamps: 1 x Cree_XP-G3_6x2_(XPGDWT-B1-6C1-S3-0-01)_1521.26lm@250mA_P=8.253W_I=0.25A

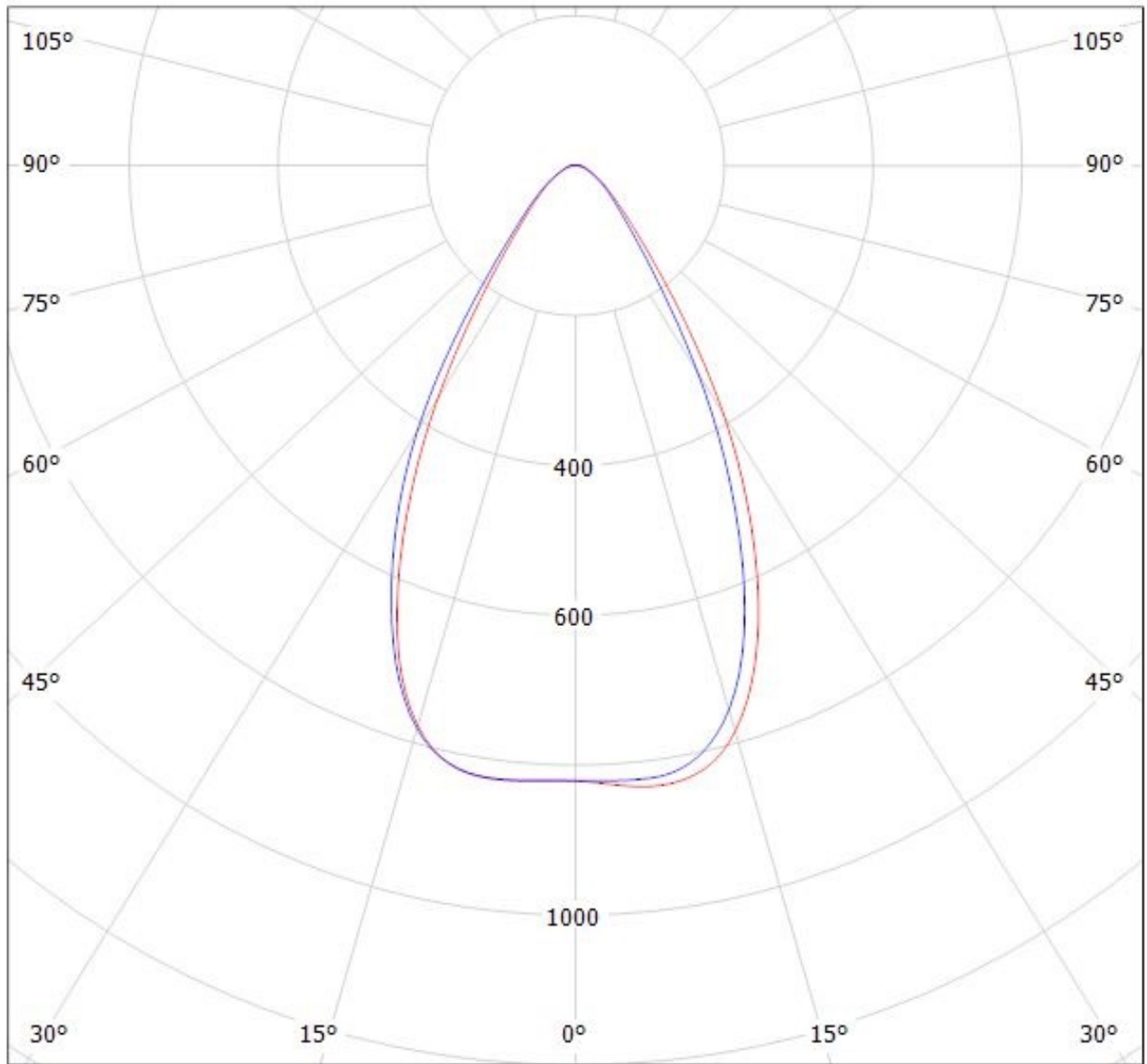

cd/klm

— C0 - C180 — C90 - C270

$\eta = 94\%$

Luminaire: Ledil Oy CS14130_HB-IP-2X6-W-MH-B_SIMULATED
Lamps: 1 x Cree MH-B

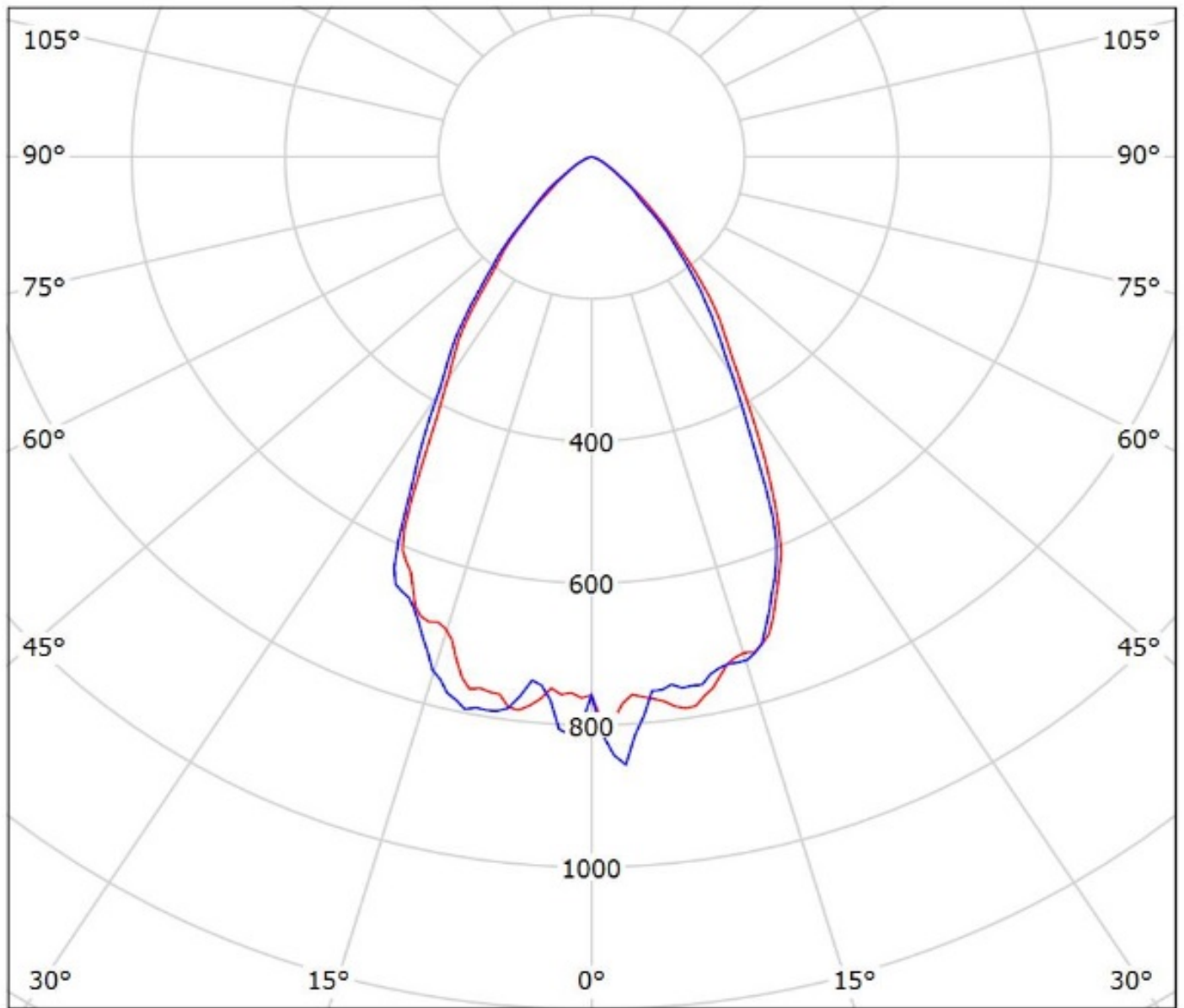

cd/klm
— C0 - C180 — C90 - C270

$\eta = 91\%$

Luminaire: Ledil CS14130_HB-IP-2X6-W_(XP-L2)

Lamps: 1 x Cree_XP-L2_2x6_1659.4lm@250mA_P=8.22525W_η=0.25A

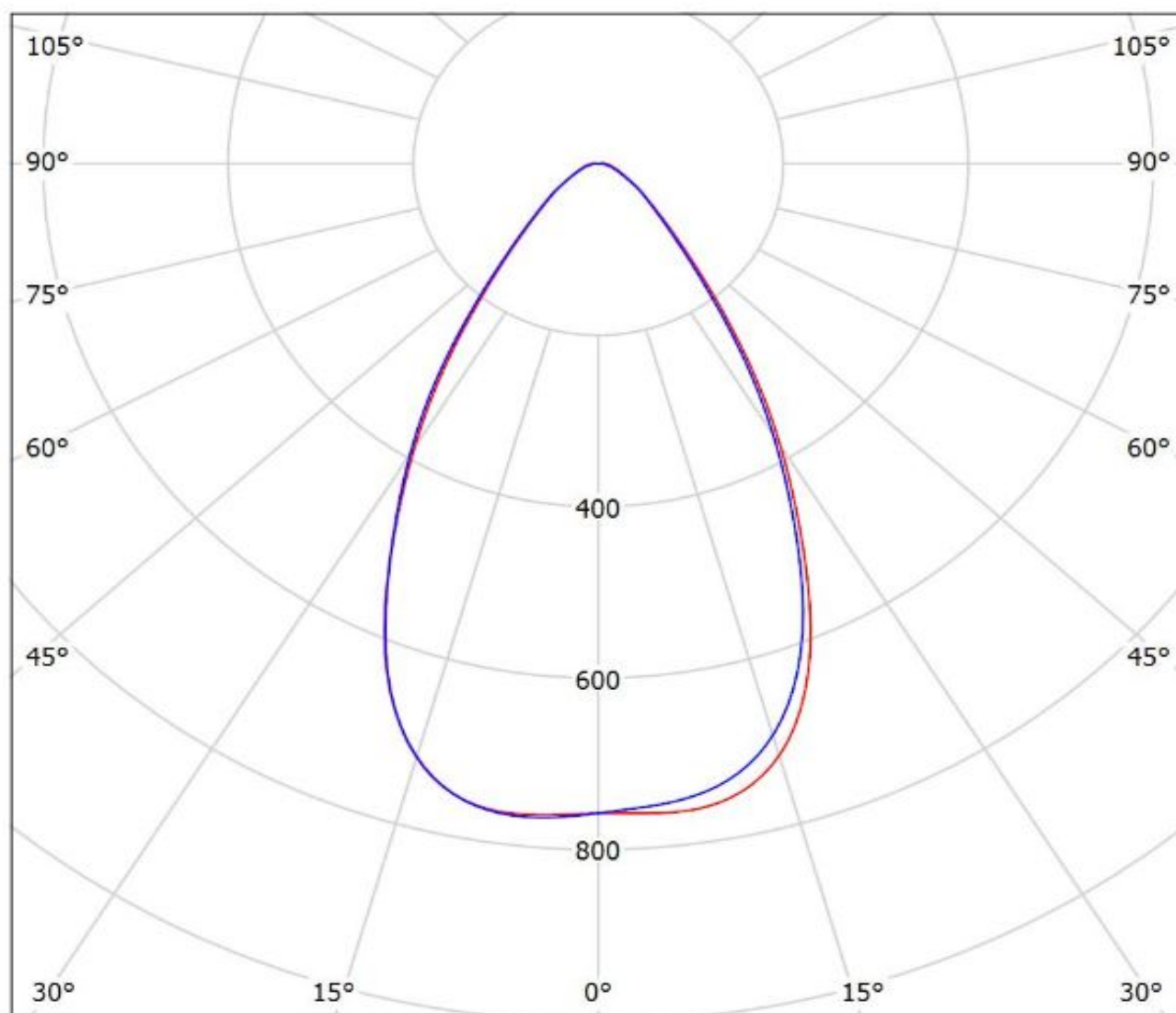

cd/klm

$\eta = 95\%$

— C0 - C180 — C90 - C270

Luminaire: Ledil Oy CS14130_HB-IP-2X6-W_(H35C1)_SIMULATED

Lamps: 1 x LG H35C1

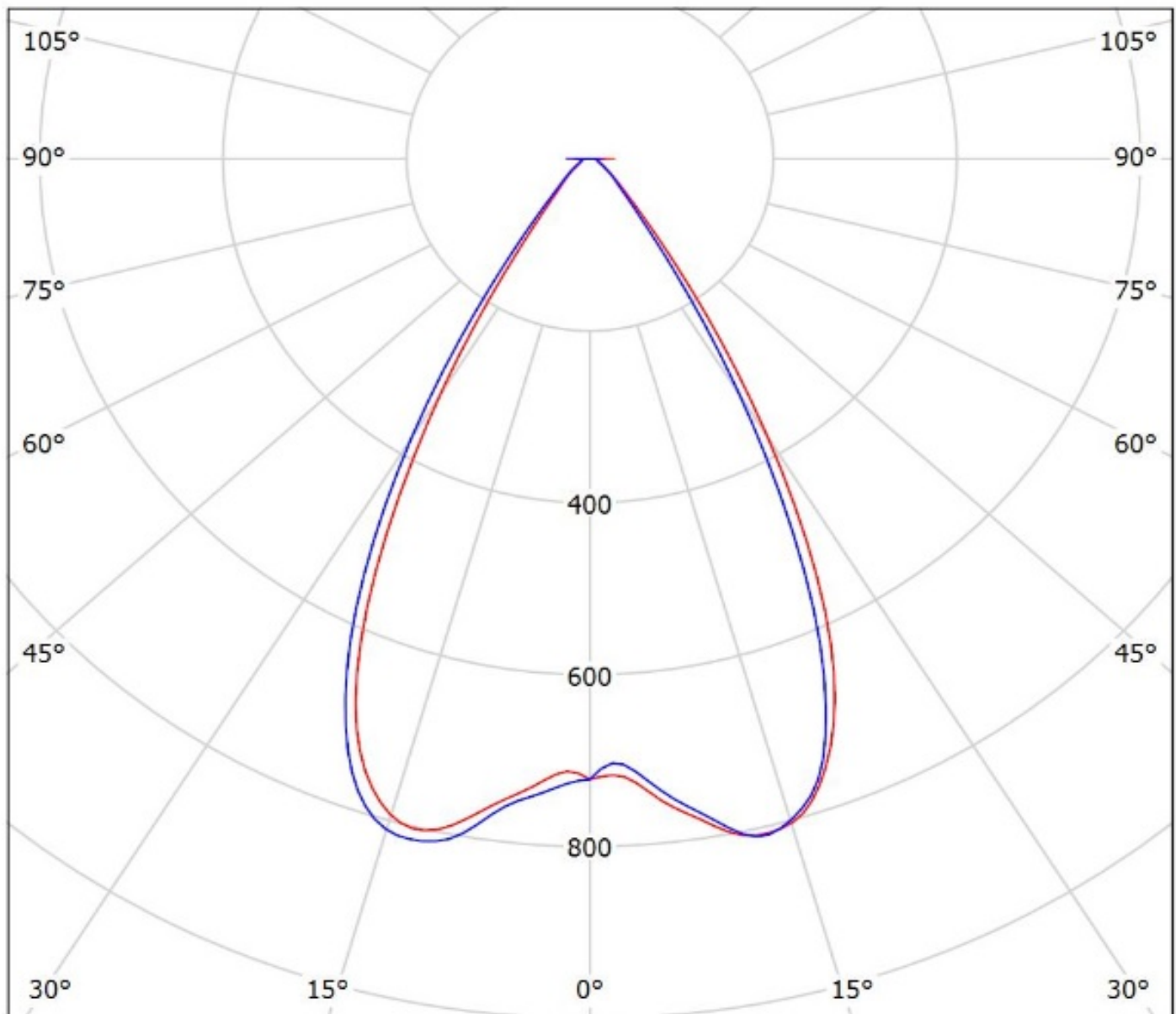

cd/klm

— C0 - C180 — C90 - C270

$\eta = 95\%$

Luminaire: LEDiL Oy CS14130_HB-IP-2X6-W_(LUXEON_T) Eff.94.0%

Lamps: 1 x LUXEON_T_6x2_(LXH8-FW30)_1062.6lm@250mA_P=8.46572W_I=249.8mA

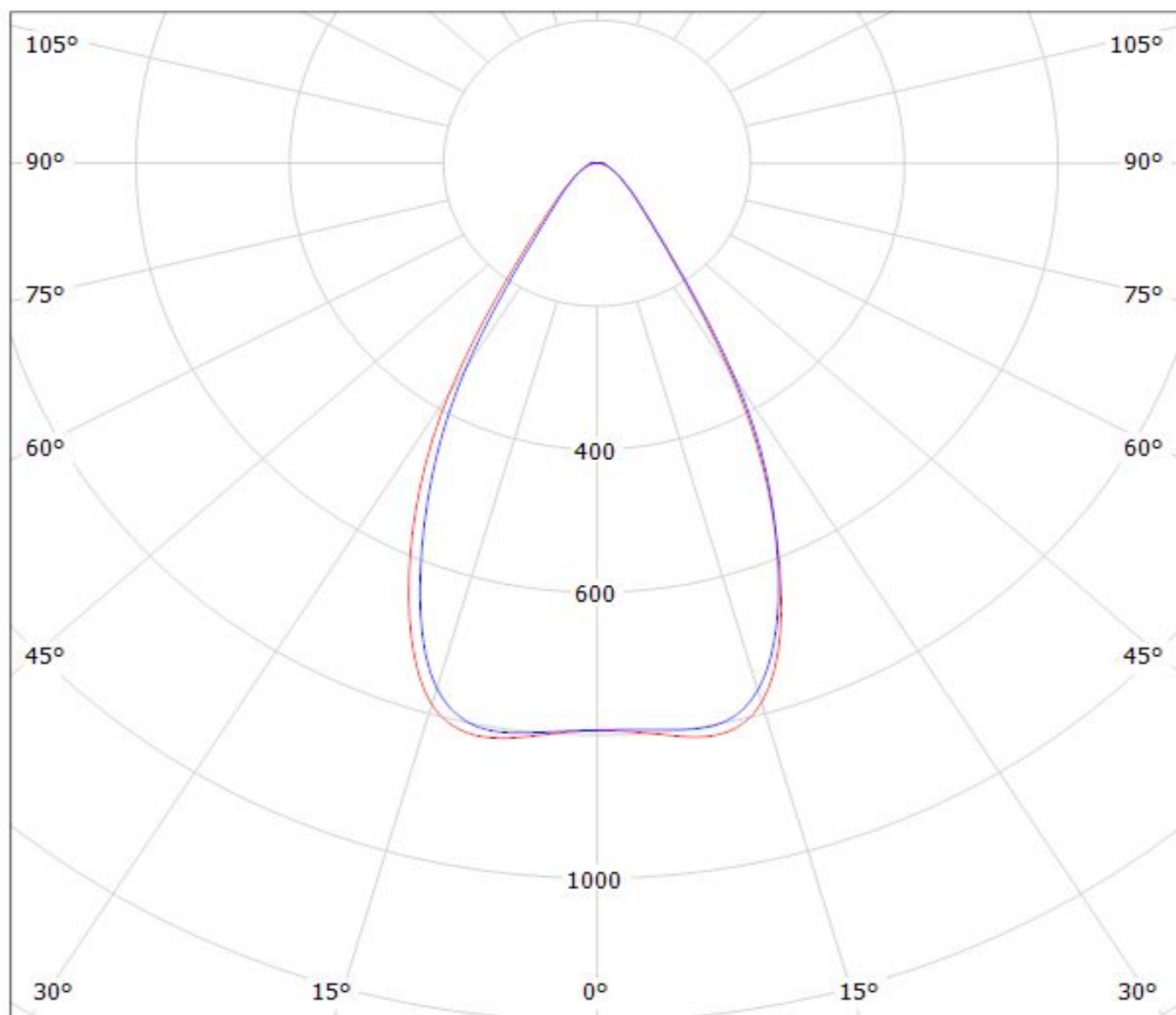

cd/klm

— C0 - C180

— C90 - C270

$\eta = 94\%$

Luminaire: LEDiL Oy CS14130_HB-IP-2X6-W_(REBEL-ES) Eff.94.0%
Lamps: 1 x Luxeon_Rebel-ES_2x6_864.2lm@250mA_P=9.03127W_I=249.8mA

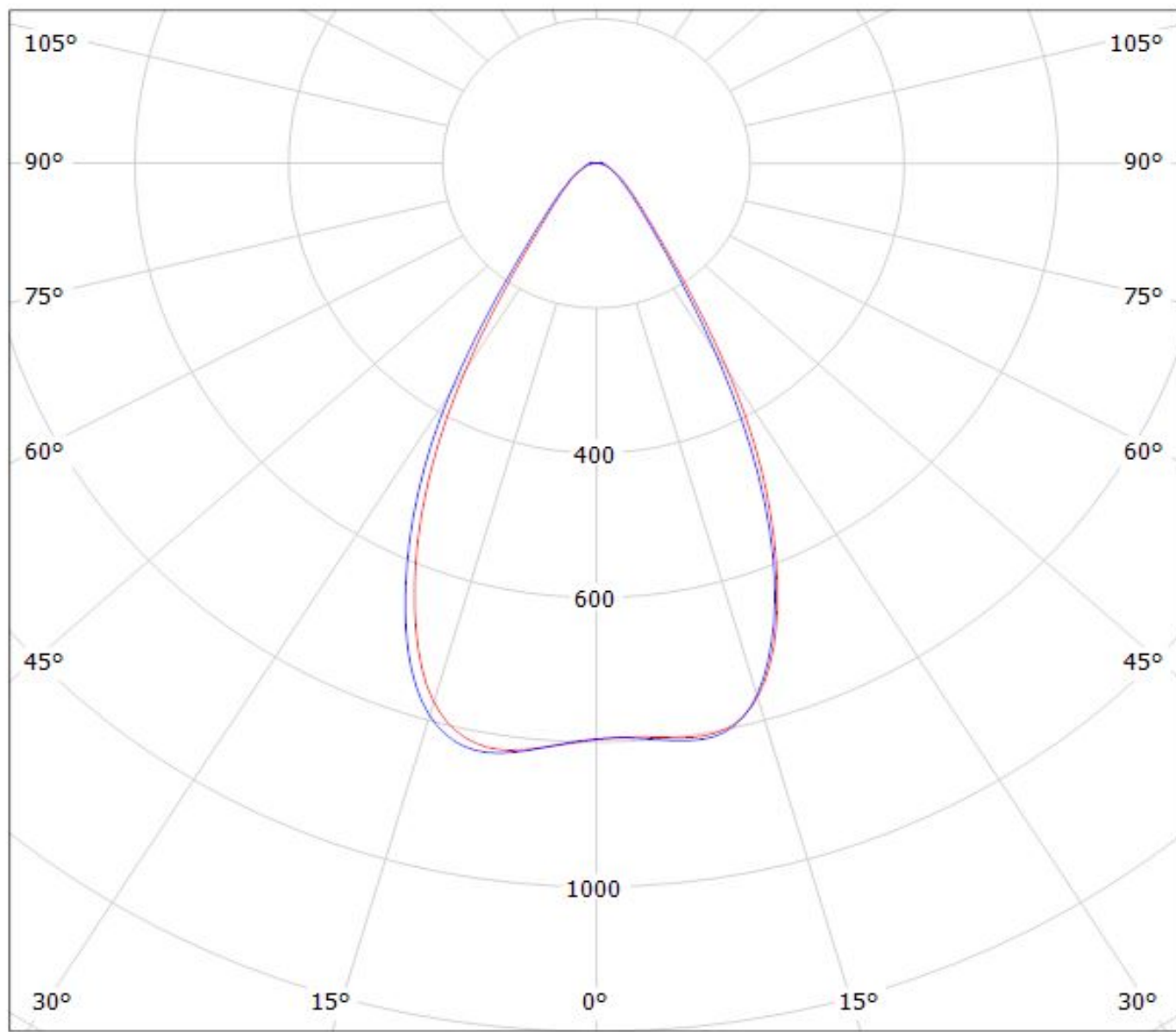

cd/klm

— C0 - C180 — C90 - C270

$\eta = 94\%$

Luminaire: LEDiL Oy CS14130_HB-IP-2X6-W_(LUXEON-R) Eff.94.0%
Lamps: 1 x Luxeon_R_6x2_1154lm@250mA_P=8.29161W_I=249.8mA

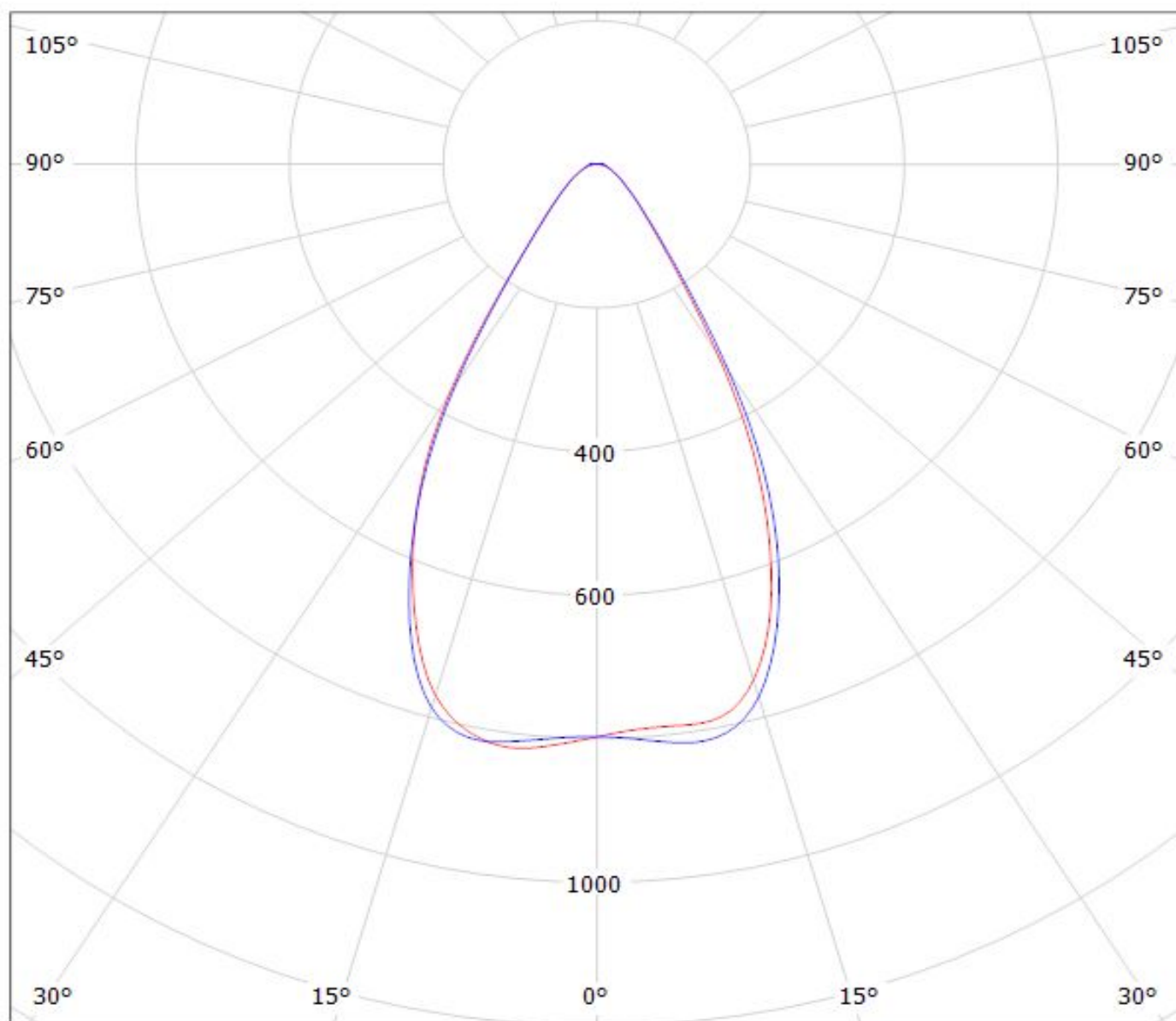

cd/klm

— C0 - C180

— C90 - C270

$\eta = 94\%$

Luminaire: LEDiL Oy CS14130_HB-IP-2X6-W_(LUXEON_Z_ES) Eff.94.0%
Lamps: 1 x LUXEON_Z_ES_990.2lm@250mA_P=8.31159W_I=249.8mA

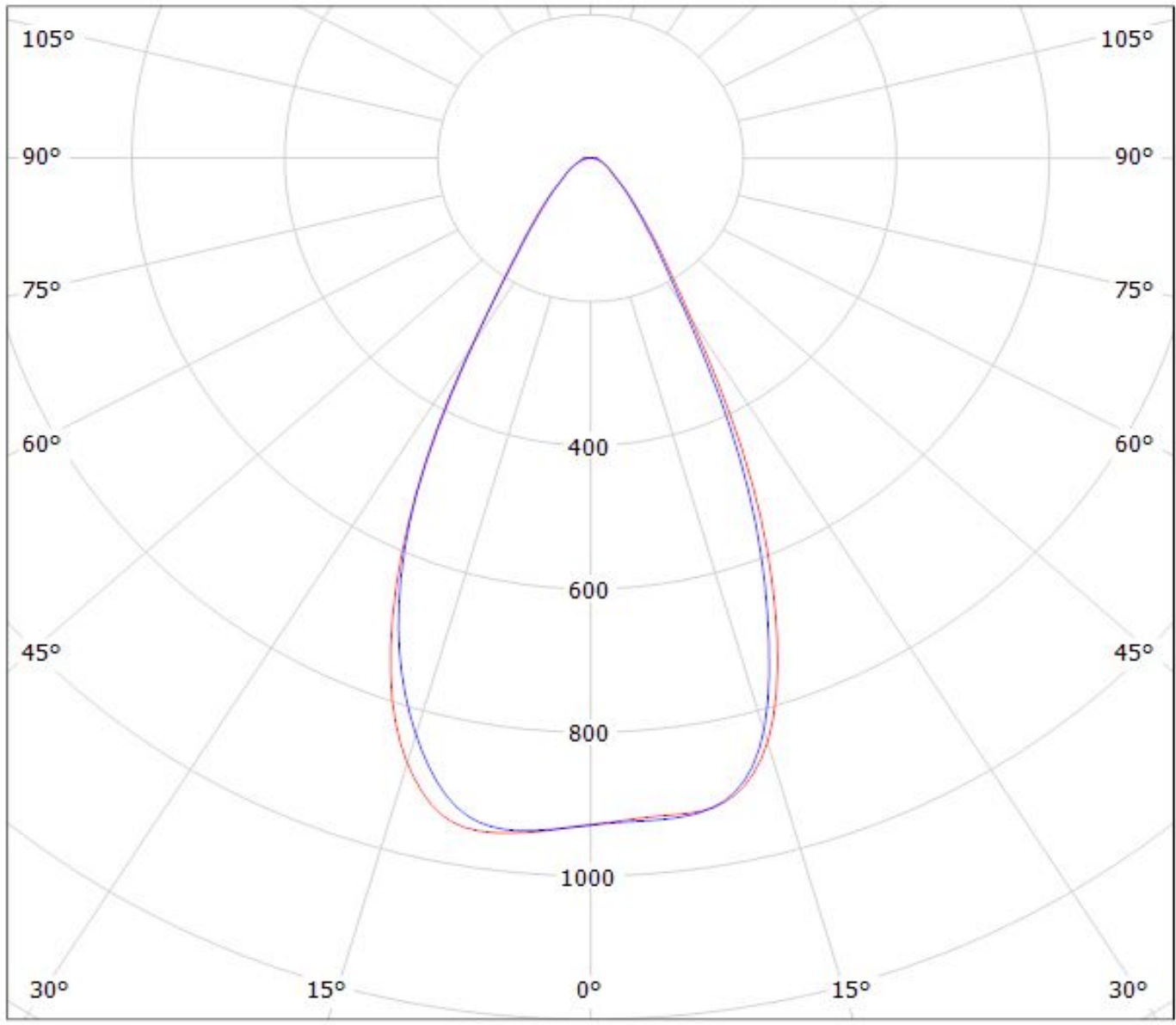

cd/klm

— C0 - C180 — C90 - C270

$\eta = 94\%$

Luminaire: LEDiL Oy CS14130_HB-IP-2X6-W_(Luxeon_TX)
Lamps: 1 x Luxeon_TX_2x6_1301.4lm@250mA_P=8.26138W_I=249.8mA

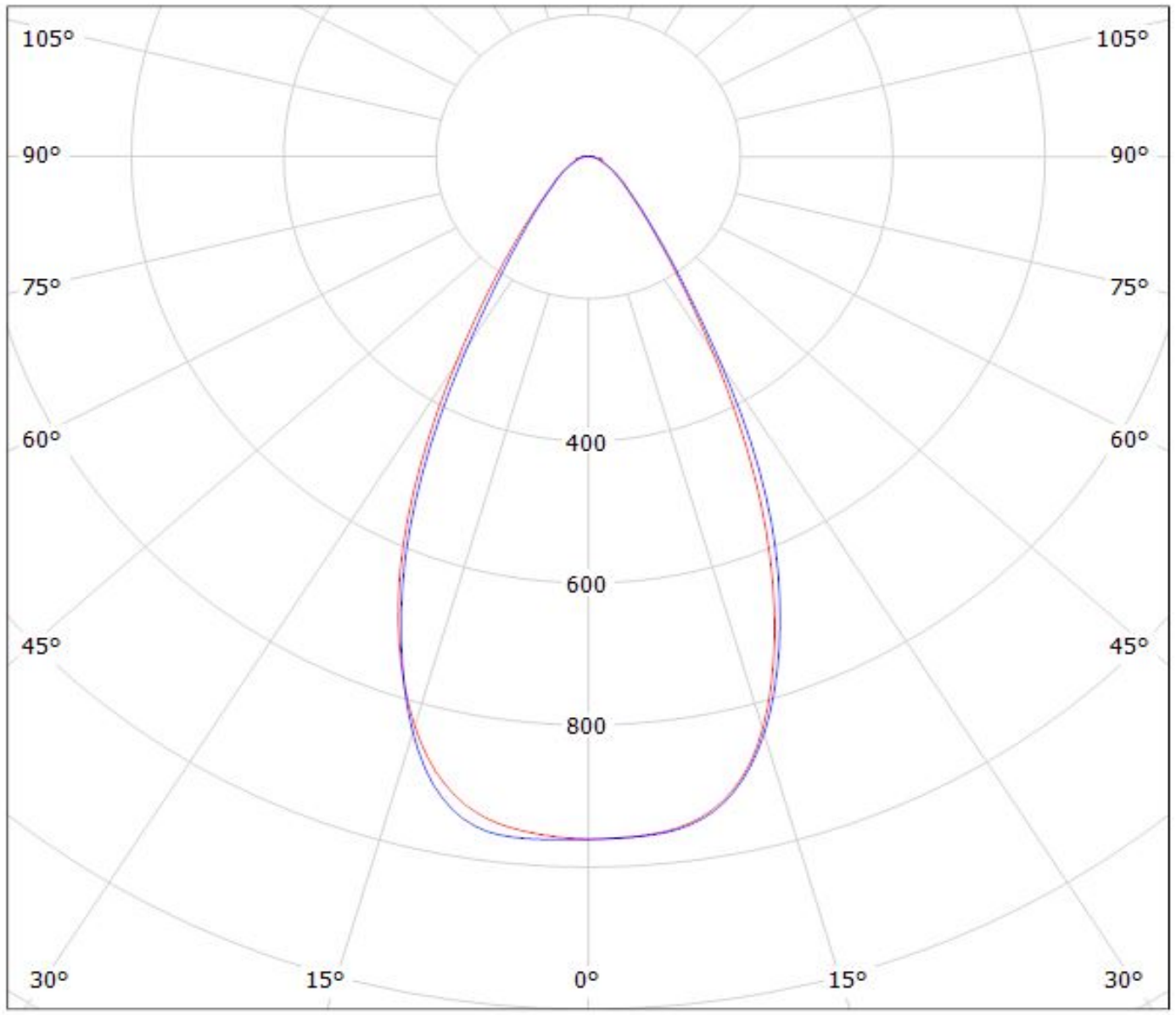

cd/klm

— C0 - C180

— C90 - C270

$\eta = 94\%$

Luminaire: Ledil CS14130_HB-IP-2X6-W_(XR-TX)

Lamps: 1 x Luxeon_XR-TX_1376.41lm@250mA_P=8.3920W_I=0.250A

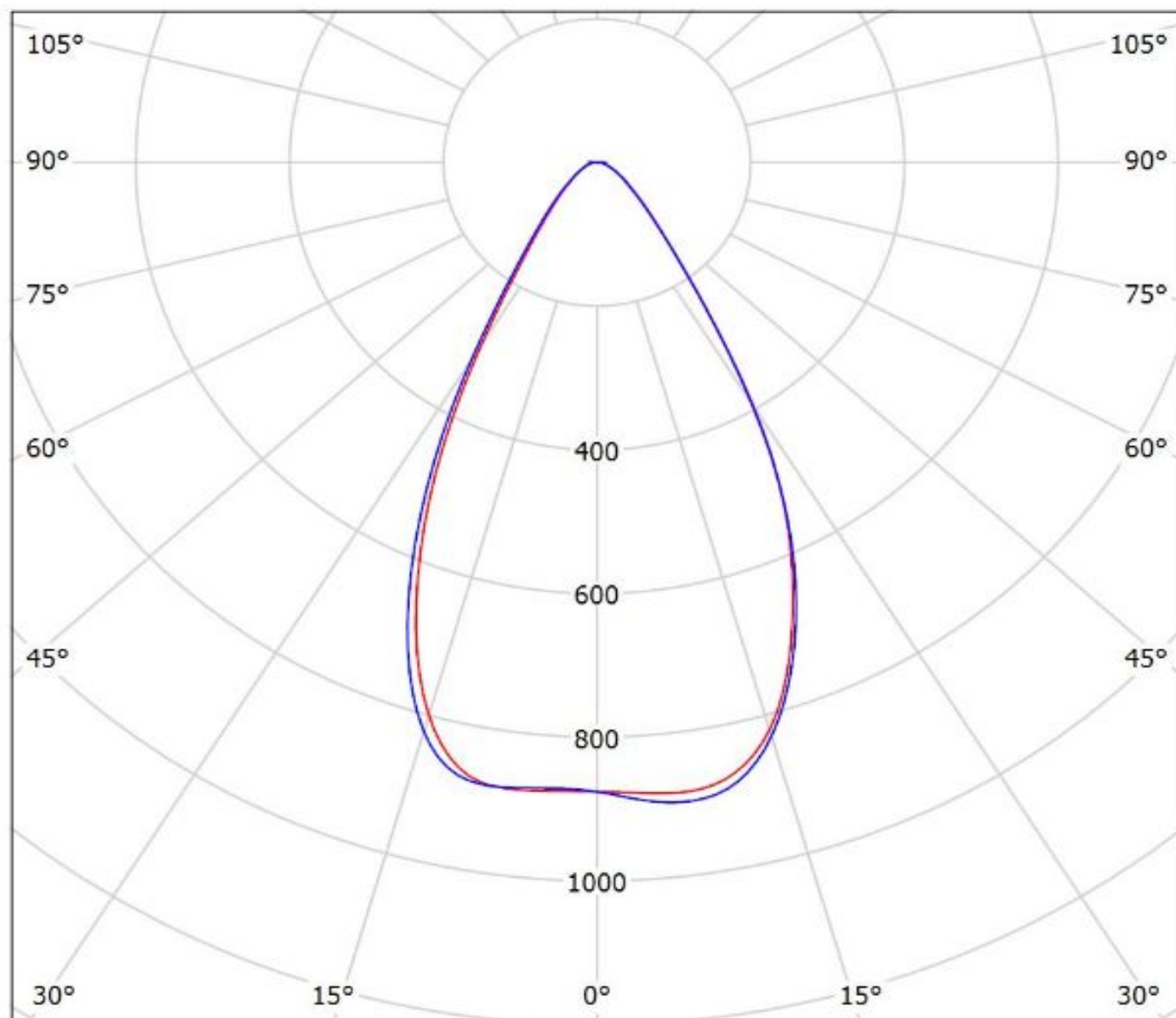

cd/klm

— C0 - C180

— C90 - C270

$\eta = 95\%$

Luminaire: Ledil CS14130_HB-IP-2X6-W_(NVSL219CT)

Lamps: 1 x Nichia_NVSL219CT_2x6_1262.53lm@250mA_P=8.35825W_I=0.25A

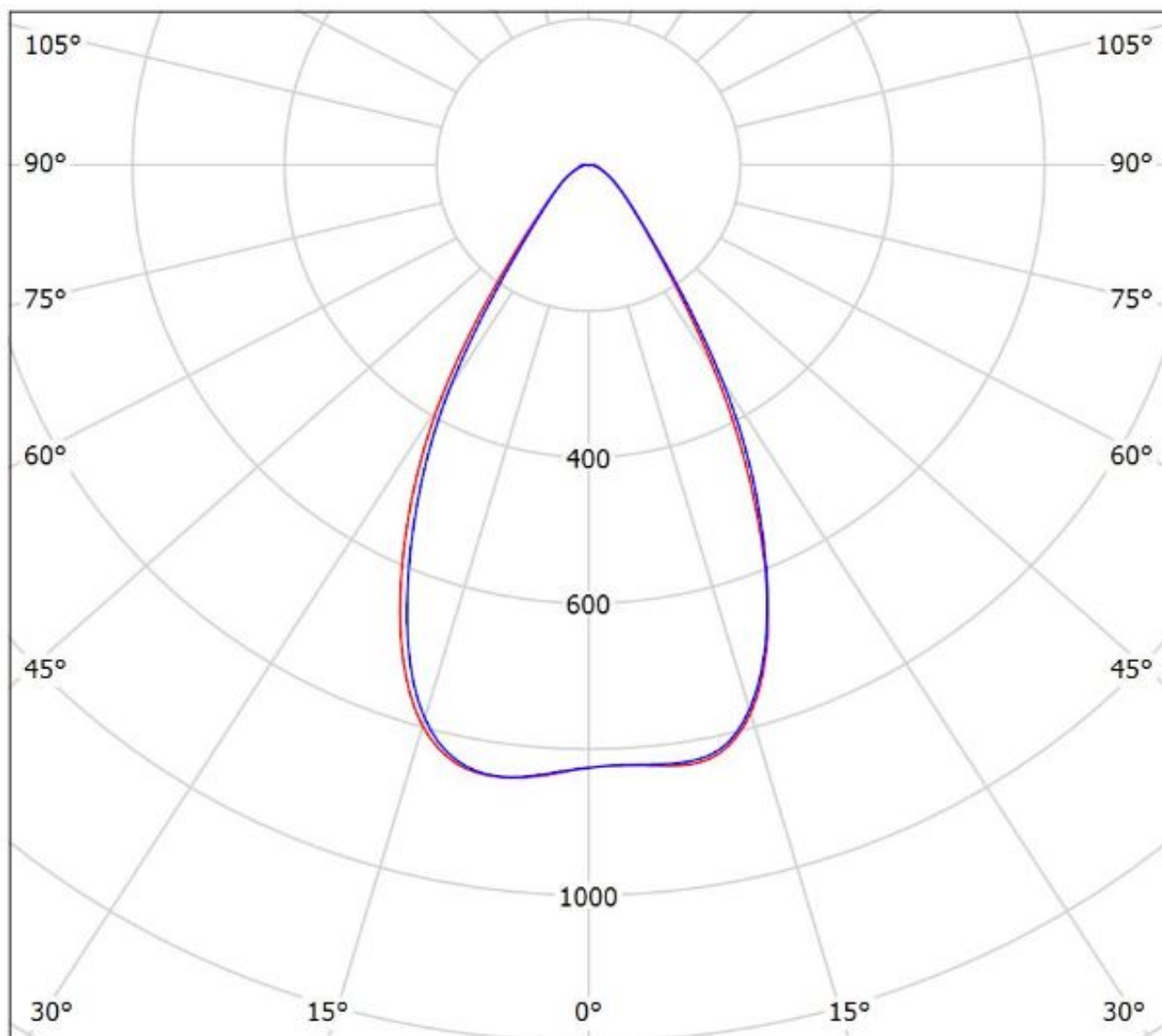

cd/klm

— C0 - C180

— C90 - C270

$\eta = 94\%$

Luminaire: LEDiL Oy CS14130_HB-IP-2X6-W_(Nichia_E21)

Lamps: 1 x Nichia_NVSW21A_583.232lm@600mA_P=3.51742W_I=0.600A

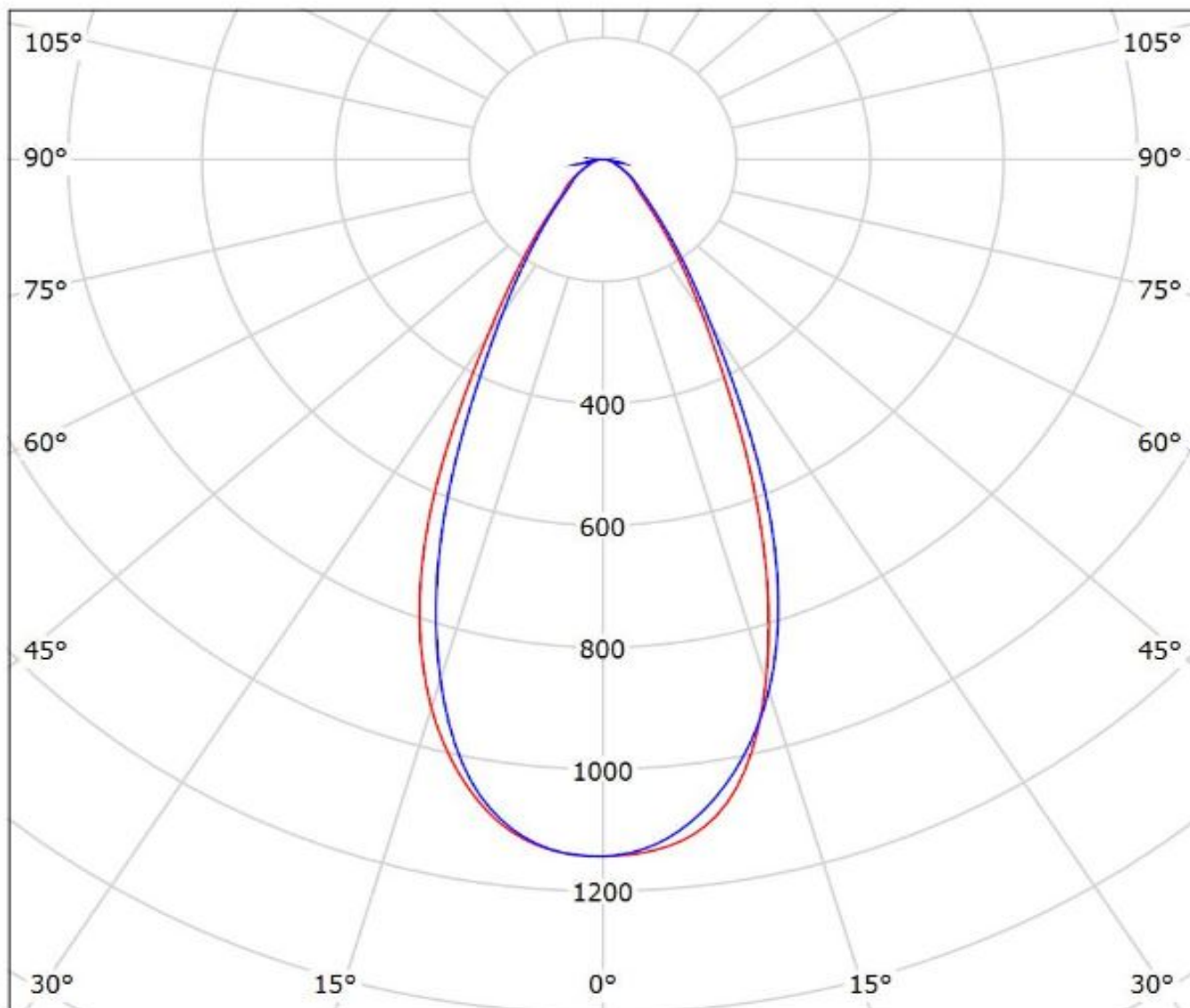

cd/klm

— C0 - C180 — C90 - C270

$\eta = 96\%$

Luminaire: Ledil Oy CS14130_HB-IP-2X6-W-DURIS-S8_SIMULATED
Lamps: 1 x DURIS-S8

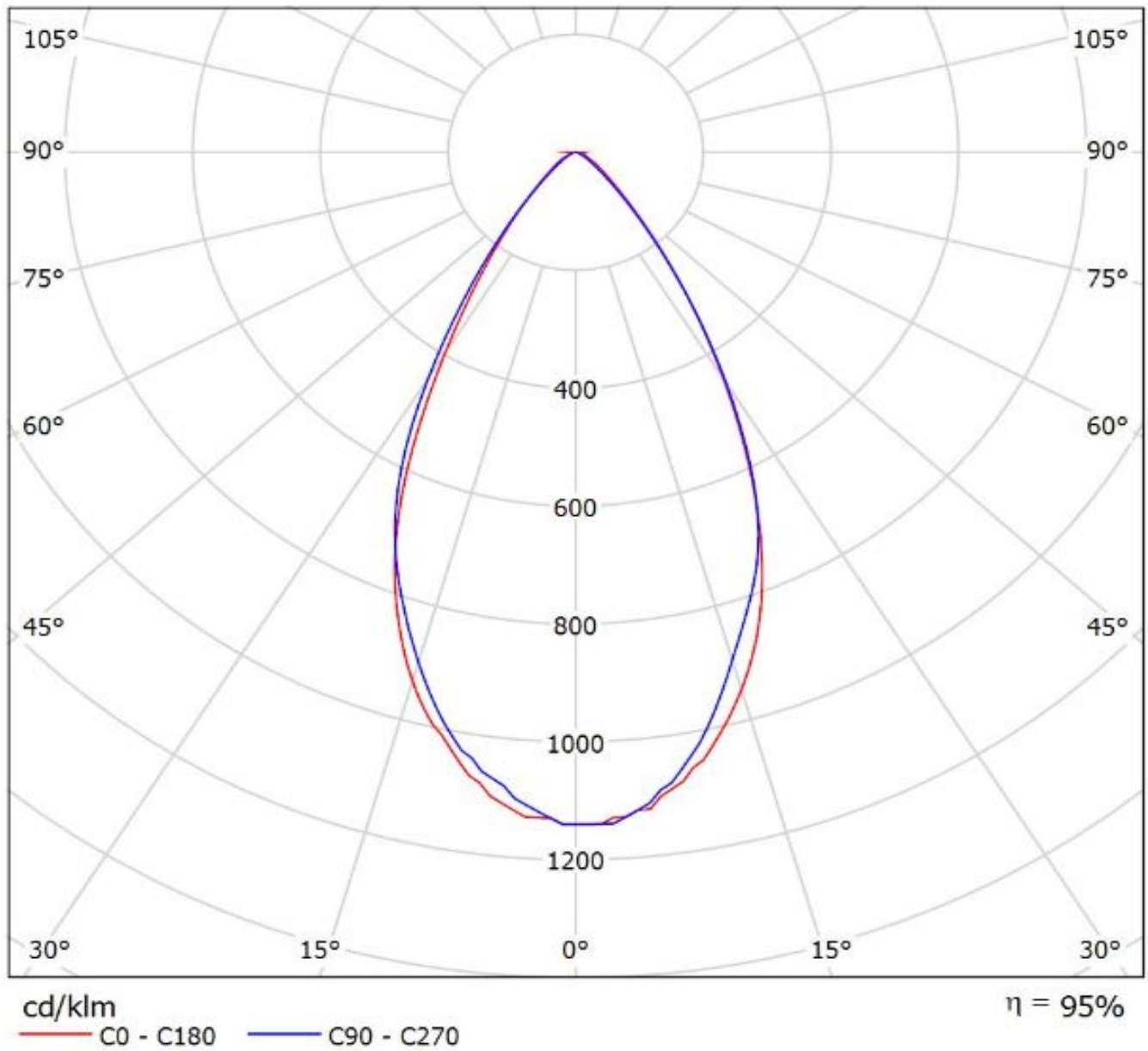

Luminaire: LEDiL Oy CS14130_HB-IP-2X6-W_(Z5M1) Eff.94.0%

Lamps: 1 x SEOUL_Z5M1_2x6_(SZ5-M1-WW-C8)_1177.2lm@250mA_P=8.5619W_I=249.8mA

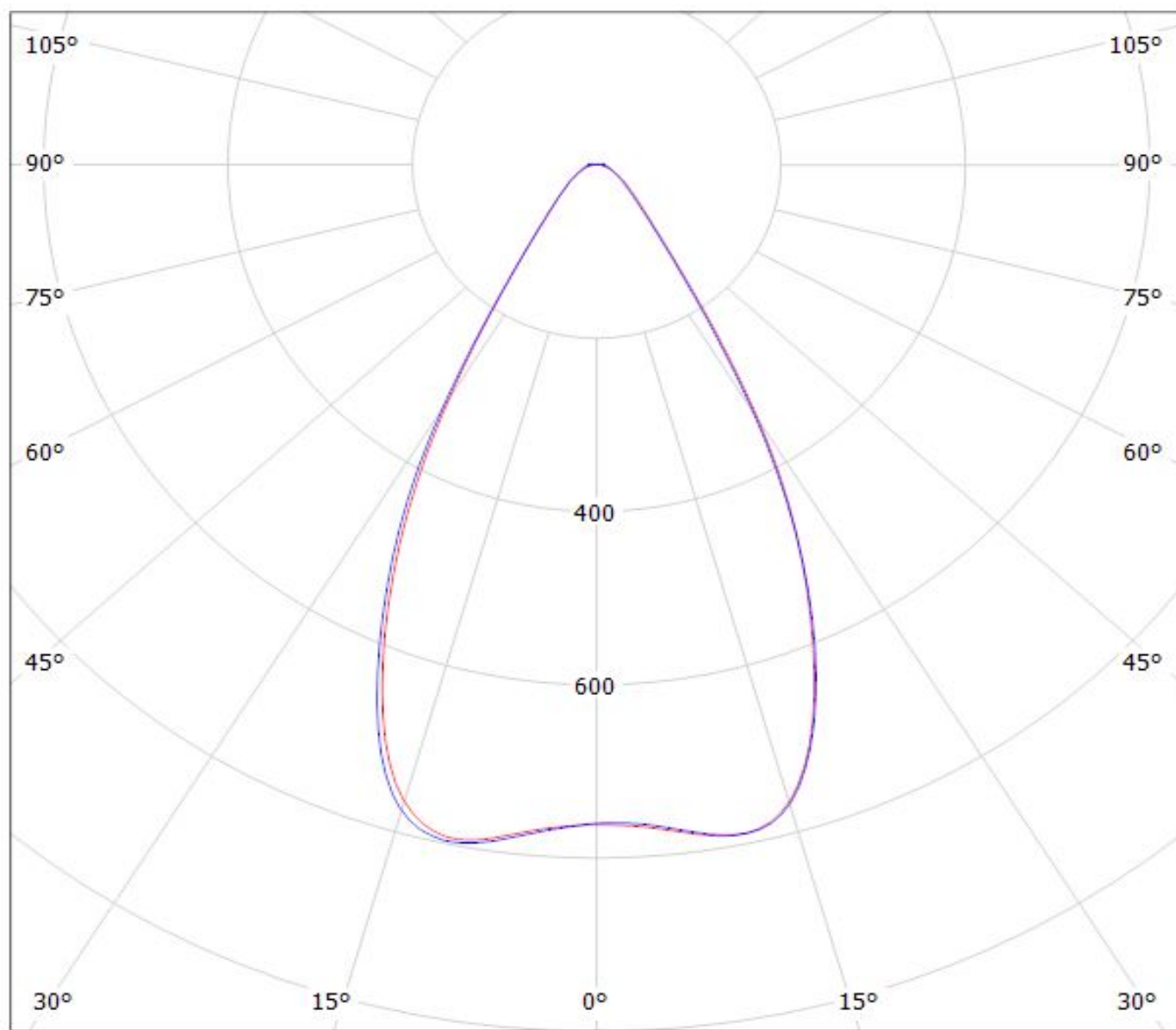

cd/klm

— C0 - C180

— C90 - C270

$\eta = 94\%$

Luminaire: Ledil Oy CS14130_HB-IP-2X6-W_MJT4040_SIMULATED

Lamps: 1 x

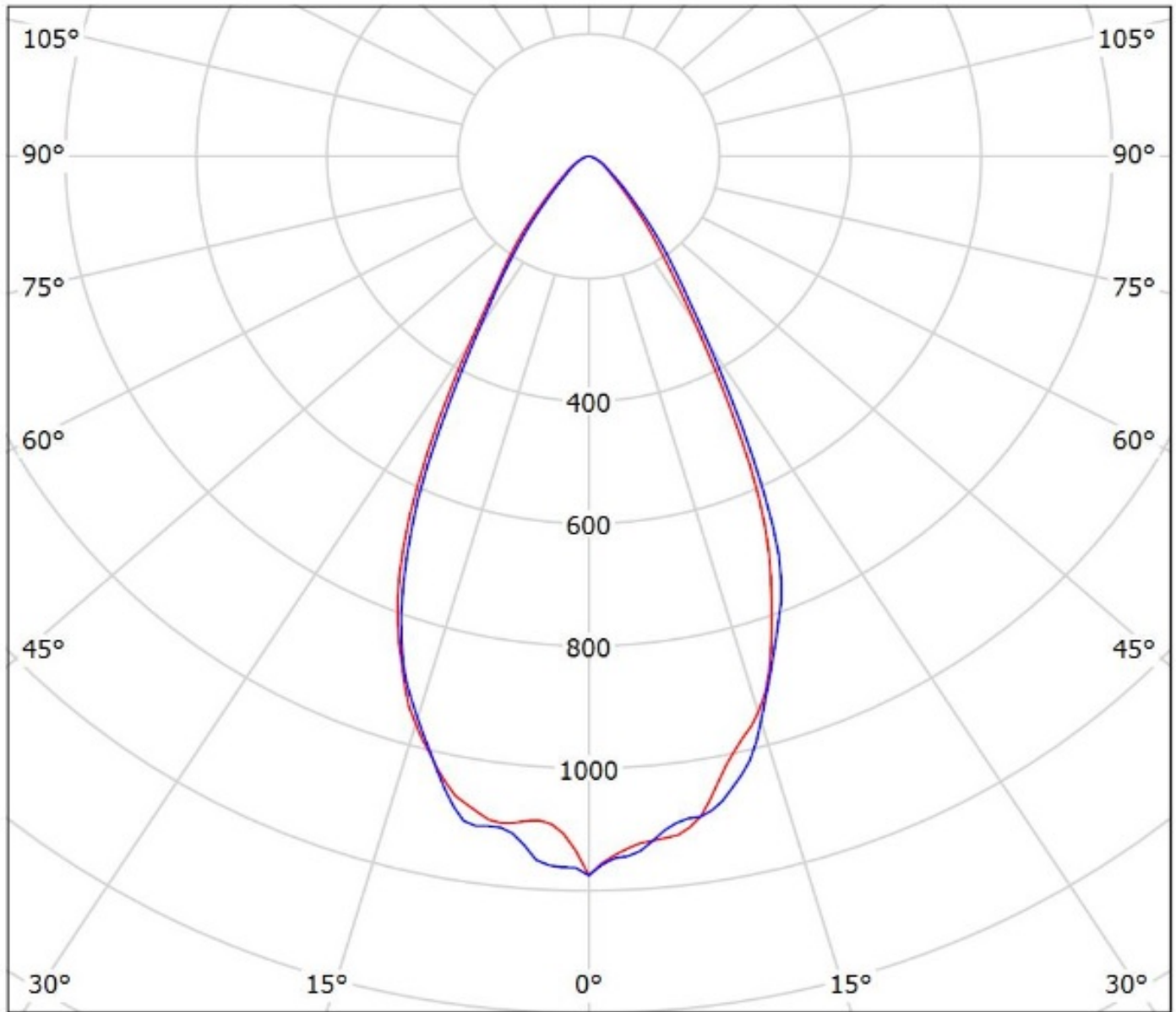

cd/klm

— C0 - C180 — C90 - C270

$\eta = 93\%$

Ledil Oy CS14130HB-IP-2X6-W / LDC (Polar)

Luminaire: Ledil Oy CS14130HB-IP-2X6-W
Lamps: 1 x SEOUL_Z5M

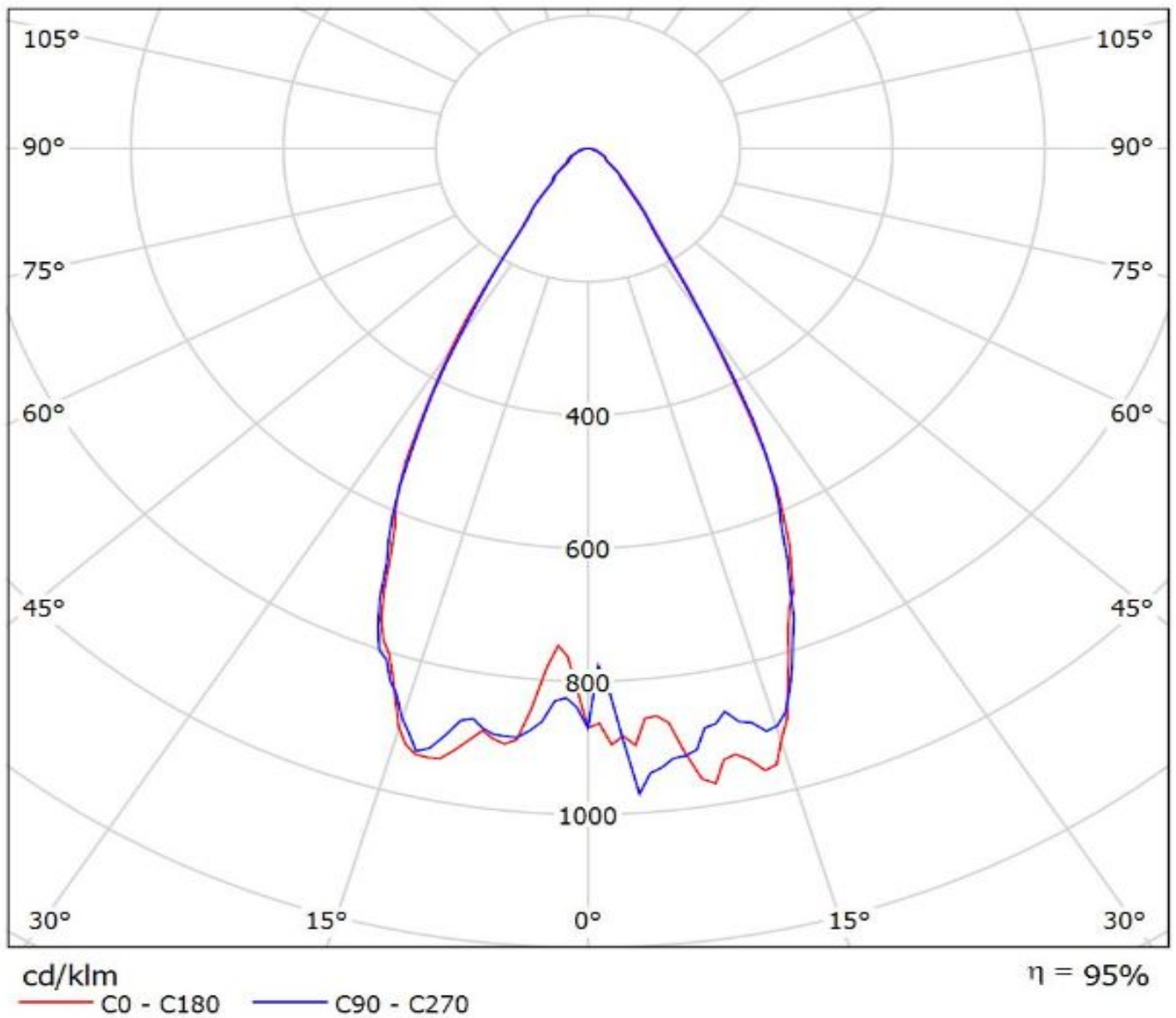

Luminaire: Ledil CS14130_HB-IP-2X6-W_(Z8Y22_PLUS)

Lamps: 1 x Seoul_Z8Y22_PLUS_2X6_(SZ8-Y22-W0-C7P)1489.65lm@250mA_P=8.30675W_I=0.250A

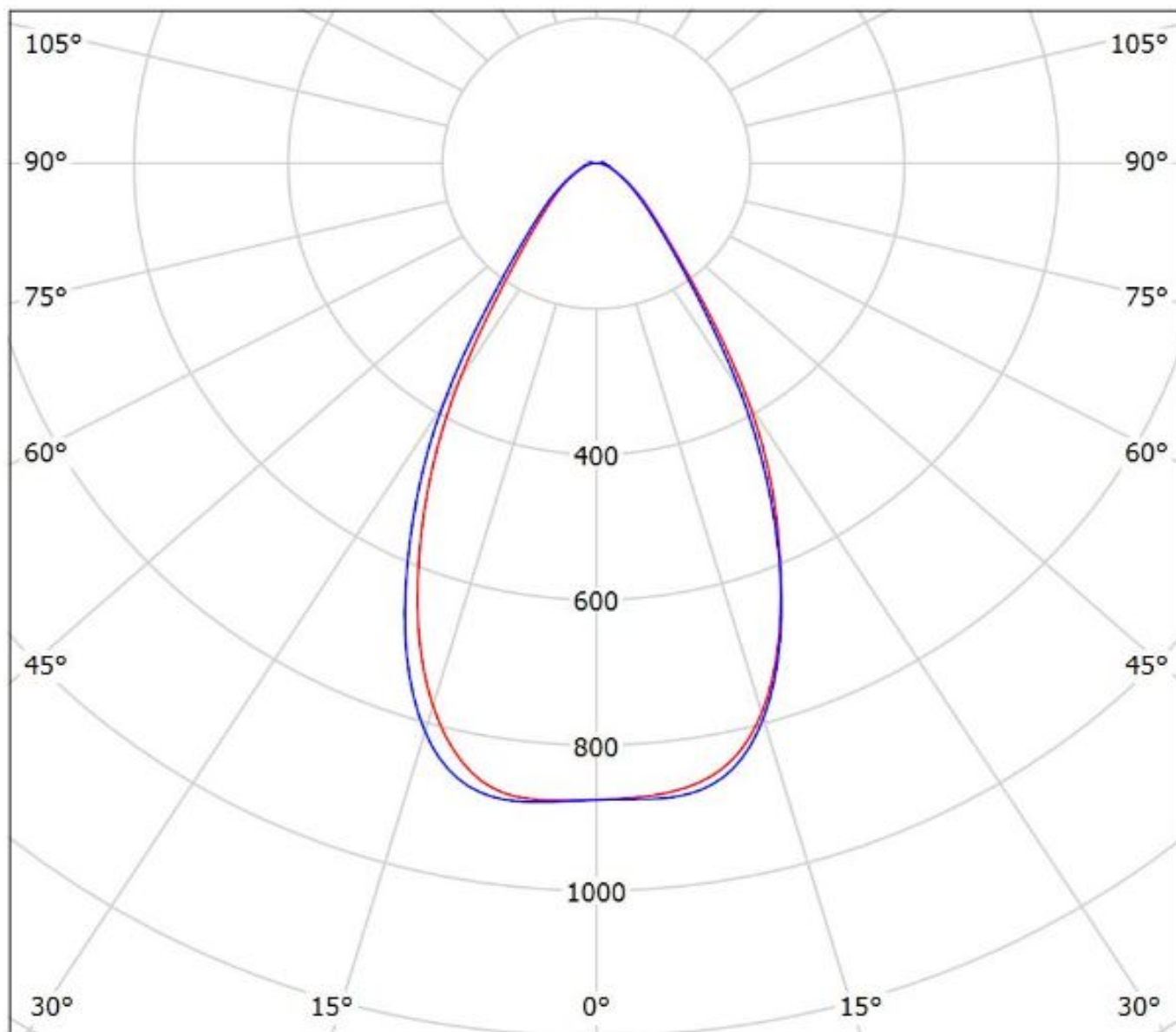

cd/klm

— C0 - C180

— C90 - C270

$\eta = 95\%$

Ledil CS14130_HB-IP-2X6-W_(TL1L4) / LDC (Polar)

Luminaire: Ledil CS14130_HB-IP-2X6-W_(TL1L4)

Lamps: 1 x Toshiba_TL1L4_2x6_(TL1L4-DW0)_1263.19lm@250mA_CCT=6500K_P=8.5W_I=0.25A

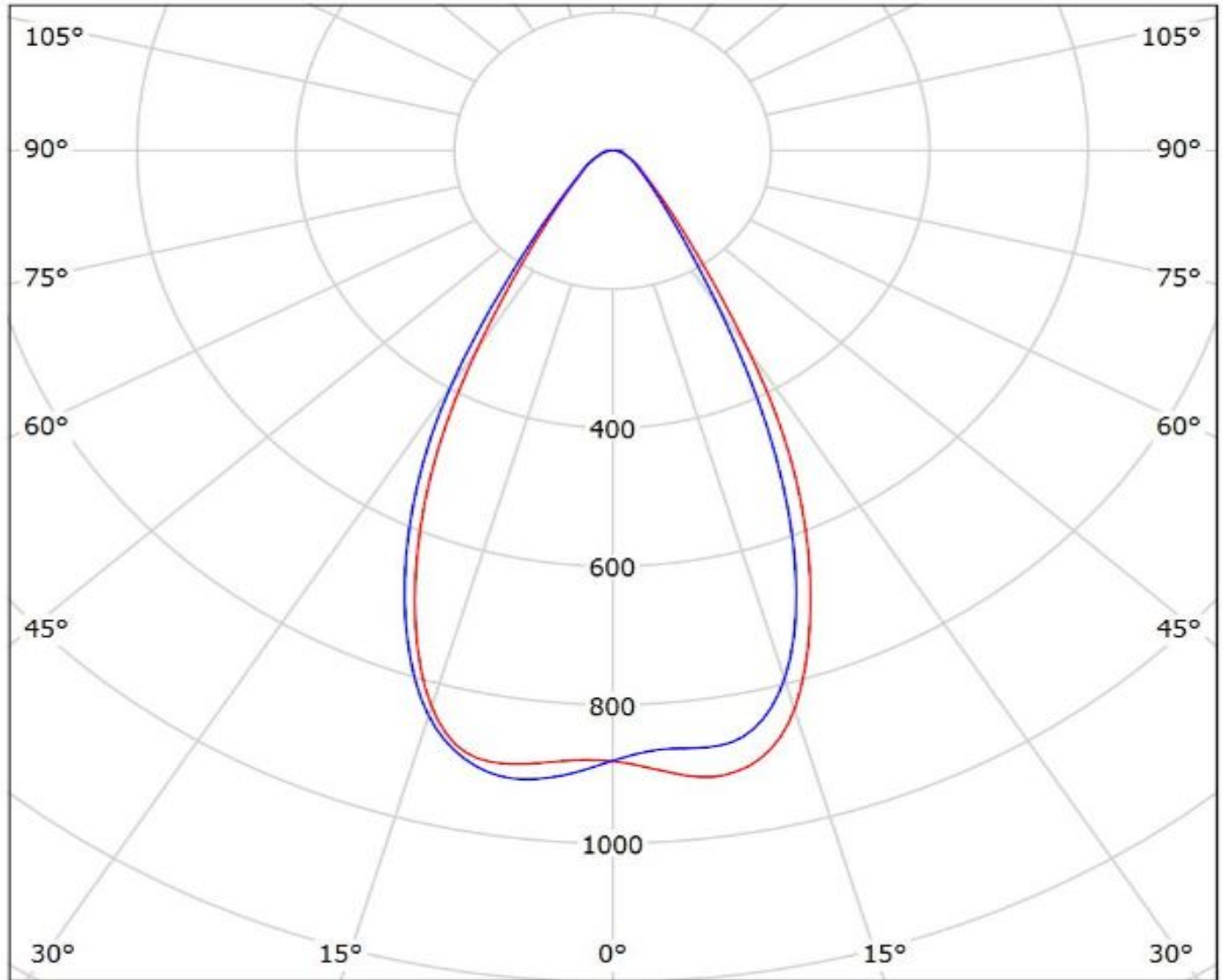

cd/klm

— C0 - C180 — C90 - C270

$\eta = 95\%$

NOTE: The typical divergence will be changed by different color, chip size and chip position tolerance. The typical total divergence is the full angle measured where the luminous intensity is half of the peak value.