

## SPECIFICATION

Part No.	:	<b>MA411.A.LBI.001</b>
Product Name	:	MA411 Storm 3in1 Screw mount Antenna LTE MIMO + GPS/GLONASS/BeiDou
Features		2* LTE MIMO Antennas 698 to 960MHz/1710 to 2170MHz/ 2490 to 2690MHz/3300 to 3600 MHz Worldwide 4G Bands including 3G and 2G 1* GPS-GLONASS-BEIDOU Antenna Screw-Mount [Permanent Mount] Aerodynamic, Super Low-profile Vandal Resistant Housing IP67 Enclosure Dims: 216.24*93.25*30.95mm 0.3M low loss cable with Fakra connectors as standard Custom Cables and Connectors Available Product conforms to the EMC directive 2014/30/EU. <b>RoHS Compliant</b>



## 1. Introduction

The Storm MA411 antenna is a low profile, heavy-duty, fully IP67 waterproof external M2M antenna for use in worldwide telematics applications which require best in class LTE and GNSS performance. You will never be out of touch with this extremely robust antenna.

At only 31mm high, the Storm is the world's lowest profile global telematics antenna solution. It delivers powerful worldwide 4G LTE MIMO antenna technology while also covering the 3G and 2G bands, plus BeiDou-GPS-GLONASS for next generation location accuracy.

Typical applications

- Automotive and Heavy Equipment Vehicle Tracking and Telematics
- Remote Asset and Pipeline Monitoring
- HD Video over LTE
- First Responder and Emergency Services

LTE 4G applications demand high speed data uplink and downlink. High efficiency and high gain MIMO antennas are necessary to achieve the required signal to noise ratio and throughput required to solve these challenges. Taoglas also takes care to have high isolation between the two MIMO antennas to prevent self-interference. Low loss cables are used to keep efficiency high over long cable lengths. The MA411 does not require a ground plane. In contrast, smaller MIMO antennas with poorer quality thinner cables will have much reduced efficiency and isolation, which would lead to a large drop in system throughput or drops, and may indeed not make a system connection at all.

The BeiDou-GPS-Glonass active antenna has been carefully designed to work well on BeiDou, GPS and Glonass bands, leading to higher location accuracy and stability of tracking in urban environments.

Cable length and connector types are customizable. Contact your regional Taoglas sales office for support. Conformity is declared under the following standard:

Conformity is declared under the following standard: **EN55022 Class B**

This is to declare that the product listed above conform to the EMC directive 2014/30/EU.

## 2. Specification

BeiDou-GPS-GLONASS				
Center Frequency	BeiDou:1561.098±2.046MHz GPS:1575.42±1.023MHz GLONASS:1602±5MHz			
Passive Antenna Gain	BeiDou: 1dBi @Zenith GPS: 1dBi Typ. @Zenith GLONASS: 4dBi Typ. @Zenith			
Passive Antenna efficiency	BeiDou: 55% GPS: 55% GLONASS: 58%			
VSWR	2:1 Max			
Impedance	50Ω			
Axial Ratio	BeiDou: <5.5 GPS: <3.2 GLONASS: <10.6			
Polarization	RHCP			
Cable	0.3 meter RG174 standard, fully customizable			
Connector	Fakra (Jack) standard connector, fully customizable			
LNA and Filter Electrical Properties				
Center Frequency	BeiDou: 1561.098±2.046MHz GPS:1575.42±1.023MHz GLONASS:1602±5MHz			
SAW Filter Rejection	1651~1700MHz & 1549~1500MHz 25dB Min			
Pout 1dB gain	-6dBm Min. -2 dBm Typ.			
Compression point				
Output Impedance	50 Ohm			
VSWR	< 2:1			
Return Loss	10 dB Min.			
LNA Gain ,Power consumption and Noise Figure@GPS	Voltage	LNA Gain(Typ)	Power Consumption(mA) Typ	Noise Figure(Typ)
	Min 1.8V	20dB	5mA	2.7dB
	Typ 3.0V	28dB	10mA	2.4dB
	Max 5.5V	31dB	23mA	2.6dB
Total specification(Through Antenna, LNA)				
Frequency	1561.098±2.046MHz	1575.42±1.023MHz	1602±5MHz	
Gain@3V	1561MHz:29±3dBi	1575.42MHz:29±3dBi	1602MHz:32±3dBi	
Output Impedance	50Ω			

### 4G/3G/2G MIMO1 Antenna

Frequency (MHz)		LTE700	GSM850	GSM900	DCS	PCS	UMTS1	LTE2600	LTE3500
		698~803	824~894	880~960	1710~1880	1850~1990	1920~2170	2490~2690	3300~3600
Efficiency (%)									
On the 50*50cm ground plane	30cm	62.06	41.76	49.16	44.93	59.56	59.39	55.42	37.39
	1M	59.27	39.88	46.95	40.98	54.46	54.71	50.55	33.33
	2M	55.31	36.93	42.81	36.86	48.53	48.56	43.53	27.99
	3M	51.62	34.20	39.76	32.65	42.73	42.47	36.84	23.59
	5M	44.25	28.85	33.36	25.50	32.98	32.90	28.22	16.96
In free space	30cm	65.08	48.08	55.44	49.41	57.62	59.92	54.98	38.19
	1M	62.15	45.91	52.95	45.06	52.69	55.18	50.14	34.83
	2M	58.00	42.54	48.29	40.62	46.96	48.99	43.17	29.65
	3M	54.13	39.46	44.80	35.92	41.31	42.84	36.53	24.66
	5M	46.39	33.24	37.60	28.10	31.89	33.19	27.99	19.14
Average Gain(dBi)									
On the 50*50cm ground plane	30cm	-2.22	-3.98	-3.20	-3.55	-2.27	-2.27	-2.57	-4.36
	1M	-2.42	-4.18	-3.40	-3.95	-2.66	-2.63	-2.97	-4.86
	2M	-2.72	-4.51	-3.80	-4.40	-3.16	-3.14	-3.62	-5.61
	3M	-3.02	-4.84	-4.13	-4.94	-3.72	-3.73	-4.35	-6.36
	5M	-3.70	-5.58	-4.88	-6.00	-4.84	-4.84	-5.50	-7.79
In free space	30cm	-2.02	-3.19	-2.60	-3.11	-2.42	-2.23	-2.62	-4.25
	1M	-2.22	-3.39	-2.80	-3.51	-2.81	-2.59	-3.02	-4.65
	2M	-2.52	-3.72	-3.20	-3.97	-3.31	-3.10	-3.67	-5.35
	3M	-2.82	-4.05	-3.52	-4.50	-3.86	-3.69	-4.39	-6.15
	5M	-3.50	-4.79	-4.28	-5.57	-4.98	-4.80	-5.55	-7.25
Peak Gain(dBi)									
On the 50*50cm ground plane	30cm	5.37	3.66	4.35	6.24	7.04	7.11	7.91	6.46
	1M	5.17	3.46	4.15	5.84	6.64	6.81	7.51	5.96
	2M	4.87	3.06	3.75	5.34	6.14	6.31	6.91	5.16
	3M	4.57	2.76	3.45	4.84	5.64	5.71	6.21	4.46
	5M	3.87	2.06	2.65	3.74	4.44	4.61	5.11	4.82
In free space	30cm	3.54	4.07	4.13	4.67	6.57	6.69	8.11	6.27
	1M	3.34	3.87	3.93	4.27	6.17	6.35	7.71	5.87
	2M	3.04	3.47	3.53	3.77	5.67	5.79	7.11	5.17
	3M	2.74	3.17	3.23	3.27	5.07	5.19	6.41	4.37
	5M	2.04	2.37	2.43	2.17	3.97	4.09	5.31	3.27

### 4G/3G/2G MIMO2 Antenna

Frequency (MHz)		LTE700	GSM850	GSM900	DCS	PCS	UMTS1	LTE2600	LTE3500
		698~803	824~894	880~960	1710~1880	1850~1990	1920~2170	2490~2690	3300~3600
Efficiency (%)									
On the 50*50cm ground plane	30cm	64.02	46.23	45.95	66.28	61.93	55.94	67.23	32.20
	1M	61.13	44.15	43.91	60.45	56.58	51.48	61.32	28.70
	2M	57.05	40.91	40.05	54.37	50.43	45.69	52.80	24.24
	3M	53.25	37.91	37.20	48.10	44.46	39.97	44.69	20.32
	5M	45.57	31.95	31.19	37.61	34.31	30.95	34.23	14.73
In free space	30cm	55.35	40.93	43.23	62.98	59.12	53.24	67.13	31.79
	1M	52.86	39.09	41.29	57.44	54.01	49.00	61.23	28.99
	2M	49.33	36.19	37.65	51.67	48.14	43.49	52.73	24.68
	3M	46.04	33.55	34.96	45.71	42.45	38.04	44.63	20.53
	5M	39.41	28.29	29.34	35.75	32.75	29.46	34.18	15.93
Average Gain(dBi)									
On the 50*50cm ground plane	30cm	-2.17	-3.38	-3.48	-1.84	-2.17	-2.57	-1.73	-5.25
	1M	-2.37	-3.58	-3.68	-2.24	-2.56	-2.93	-2.13	-5.75
	2M	-2.67	-3.91	-4.08	-2.69	-3.06	-3.44	-2.78	-6.50
	3M	-2.97	-4.23	-4.41	-3.23	-3.62	-4.03	-3.50	-7.25
	5M	-3.64	-4.98	-5.17	-4.29	-4.74	-5.14	-4.66	-8.68
In free space	30cm	-2.87	-3.93	-3.71	-2.04	-2.39	-2.80	-1.73	-5.28
	1M	-3.07	-4.13	-3.91	-2.44	-2.78	-3.16	-2.13	-5.68
	2M	-3.37	-4.46	-4.31	-2.90	-3.28	-3.67	-2.78	-6.38
	3M	-3.67	-4.79	-4.63	-3.43	-3.84	-4.26	-3.51	-7.18
	5M	-4.35	-5.53	-5.39	-4.50	-4.96	-5.37	-4.67	-8.28
Peak Gain(dBi)									
On the 50*50cm ground plane	30cm	6.51	4.09	3.82	7.93	8.06	7.89	8.16	5.48
	1M	6.31	3.89	3.62	7.53	7.66	7.49	7.76	4.98
	2M	6.01	3.59	3.22	7.03	7.16	6.99	7.16	4.28
	3M	5.71	3.19	2.92	6.53	6.66	6.49	6.46	3.48
	5M	5.01	2.49	2.22	5.43	5.46	5.29	5.36	2.18
In free space	30cm	5.21	2.85	3.16	7.48	7.48	7.29	8.13	5.37
	1M	5.01	2.65	2.96	7.08	7.08	6.89	7.73	4.97
	2M	4.71	2.25	2.56	6.58	6.58	6.39	7.13	4.27
	3M	4.41	1.95	2.26	6.08	6.08	5.88	6.43	3.47
	5M	3.71	1.15	1.46	4.98	4.98	4.69	5.33	2.37

### ELECTRICAL

Impedance	50Ω
Polarization	Linear
VSWR	< 3.5
Cable	0.3meter CFD-200 standard, fully customizable
Connector	Fakra(Jack) standard , fully customizable

**MECHANICAL**

Antenna Dimensions	216.24*93.25*30.95mm
Casing	ABS+PC
Base and thread	Nickel Plated Aluminum
Weight (antenna)	415g
Ingress Protection Rating	IP67
Maximum Assembly Torque	39.2 N-m

**ENVIRONMENTAL**

Operation Temperature	-40°C to 85°C
Storage Temperature	-40°C to 90°C
Humidity	Non-condensing 65°C 95% RH

LTE BANDS				
Band Number	LTE/LTE- Advanced /WCDMA/HSPA.HSPA+			
	Uplink	Downlink	MIMO 1	MIMO 2
1	UL: 1920 to 1980	DL: 2110 to 2170	✓	✓
2	UL: 1850 to 1910	DL: 1930 to 1990	✓	✓
3	UL: 1710 to 1785	DL: 1805 to 1880	✓	✓
4	UL: 1710 to 1755	DL: 2110 to 2155	✓	✓
5	UL: 824 to 849	DL: 869 to 894	✓	✓
7	UL: 2500 to 2570	DL:2620 to 2690	✓	✓
8	UL: 880 to 915	DL: 925 to 960	✓	✓
9	UL: 1749.9 to 1784.9	DL: 1844.9 to 1879.9	✓	✓
11	UL: 1427.9 to 1447.9	DL: 1475.9 to 1495.9	✗	✗
12	UL: 699 to 716	DL: 729 to 746	✓	✓
13	UL: 777 to 787	DL: 746 to 756	✓	✓
14	UL: 788 to 798	DL: 758 to 768	✓	✓
17	UL: 704 to 716	DL: 734 to 746 (LTE only)	✓	✓
18	UL: 815 to 830	DL: 860 to 875 (LET only)	✓	✓
19	UL: 830 to 845	DL: 875 to 890	✓	✓
20	UL: 832 to 862	DL: 791 to 821	✓	✓
21	UL: 1447.9 to 1462.9	DL: 1495.9 to 1510.9	✗	✗
22	UL: 3410 to 3490	DL: 3510 to 3590	✓	✗
23	UL:2000 to 2020	DL: 2180 to 2200 (LTE only)	✓	✓
24	UL:1625.5 to 1660.5	DL: 1525 to 1559 (LTE only)	✗	✗
25	UL: 1850 to 1915	DL: 1930 to 1995	✓	✓
26	UL: 814 to 849	DL: 859 to 894	✓	✓
27	UL: 807 to 824	DL: 852 to 869 (LTE only)	✓	✓
28	UL: 703 to 748	DL: 758 to 803 (LTE only)	✓	✓
29	UL: -	DL: 717 to 728 (LTE only)	✓	✓
30	UL: 2305 to 2315	DL: 2350 to 2360 (LTE only)	✓	✓
31	UL: 452.5 to 457.5	DL: 462.5 to 467.5 (LTE only)	✗	✗
32	UL: -	DL: 1452 - 1496	✗	✗
35		1850 to 1910	✓	✓
38		2570 to 2620	✓	✓
39		1880 to 1920	✓	✓
40		2300 to 2400	✓	✓
41		2496 to 2690	✓	✓
42		3400 to 3600	✓	✗
43		3600 to 3800	✓	✓



### 3. Antenna Characteristics

#### 3.1 BeiDou-GPS-GLONASS Antenna

##### 3.1.1 Block Diagram

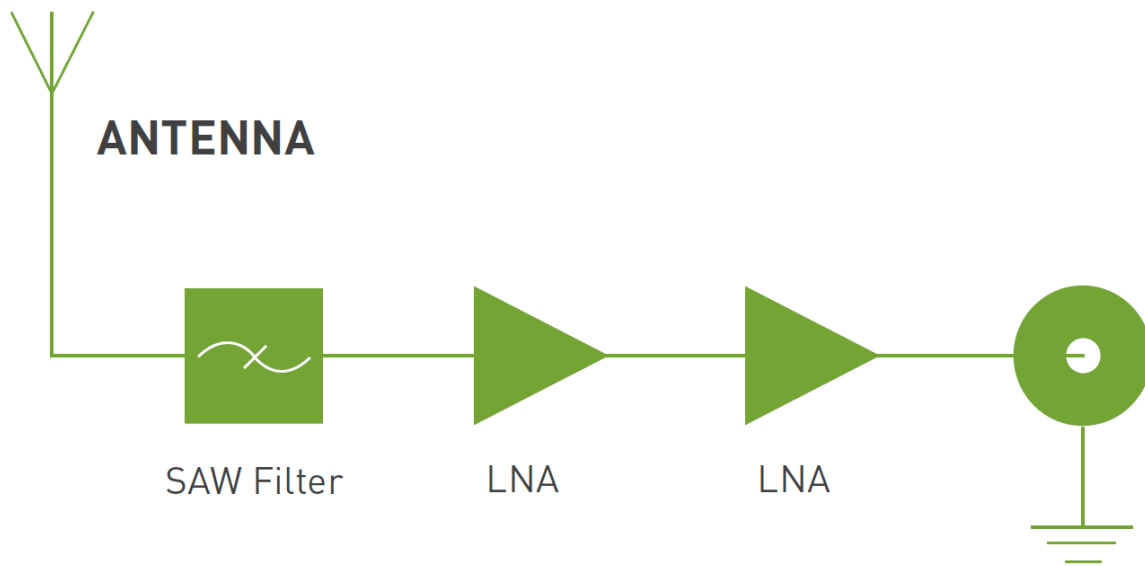

### 3.1.2 Test Setup

XZ-Plane



YZ-Plane

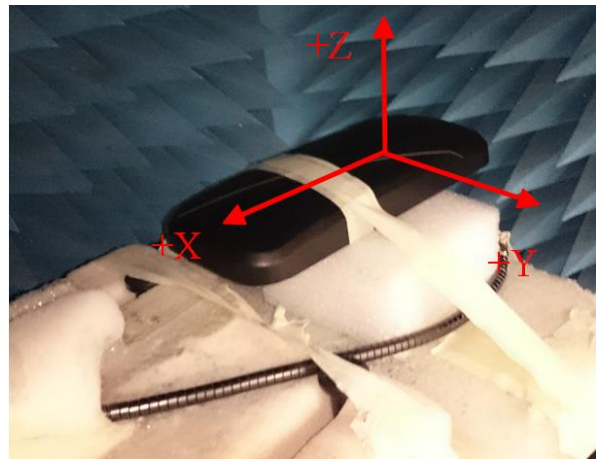

### 3.1.3 BeiDou-GPS-GLONASS Return Loss

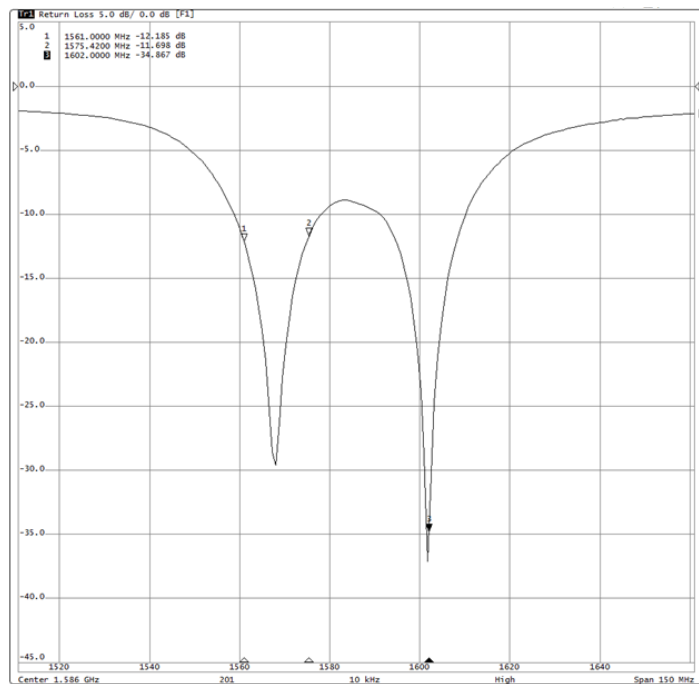

Return Loss : -12.185 dB @ 1561MHz

Return Loss : -11.698 dB @ 1575.42MHz

Return Loss : -34.867 dB @ 1602MHz

### 3.1.4 BeiDou-GPS-GLONASS Smith Chart

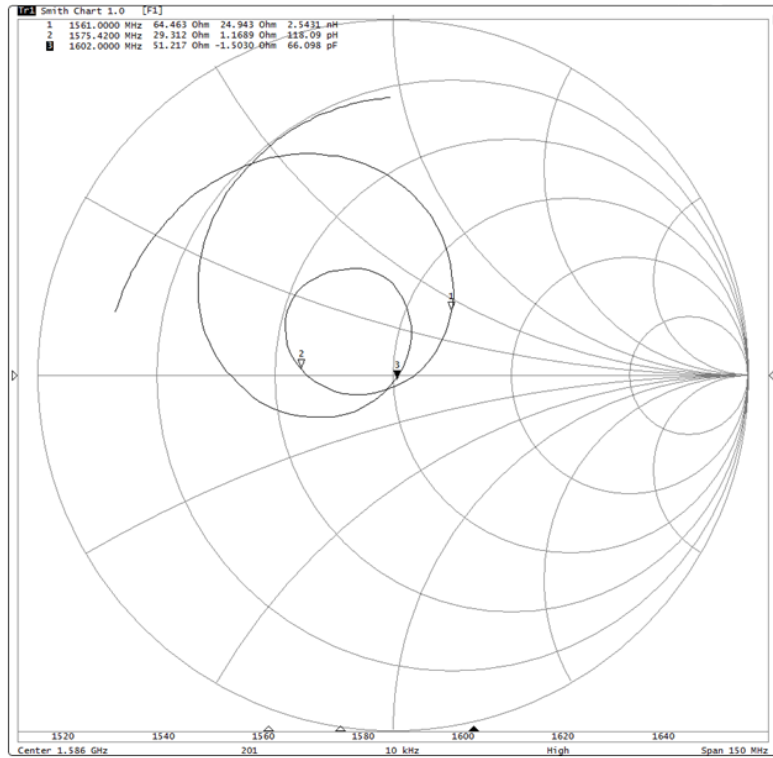

Impedance :  $64.46 + j24.94$  Ohm@ 1561MHz

Impedance :  $29.31 + j01.16$  Ohm@ 1575.42MHz

Impedance :  $51.24 - j01.50$  Ohm@ 1602MHz

### 3.1.5 BeiDou-GPS-GLONASS Radiation Pattern

Radiation pattern @ 1561MHz

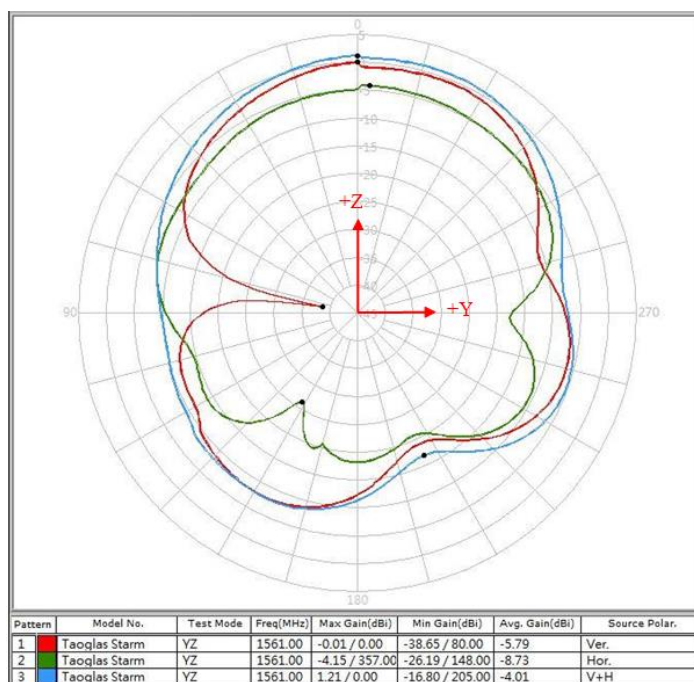
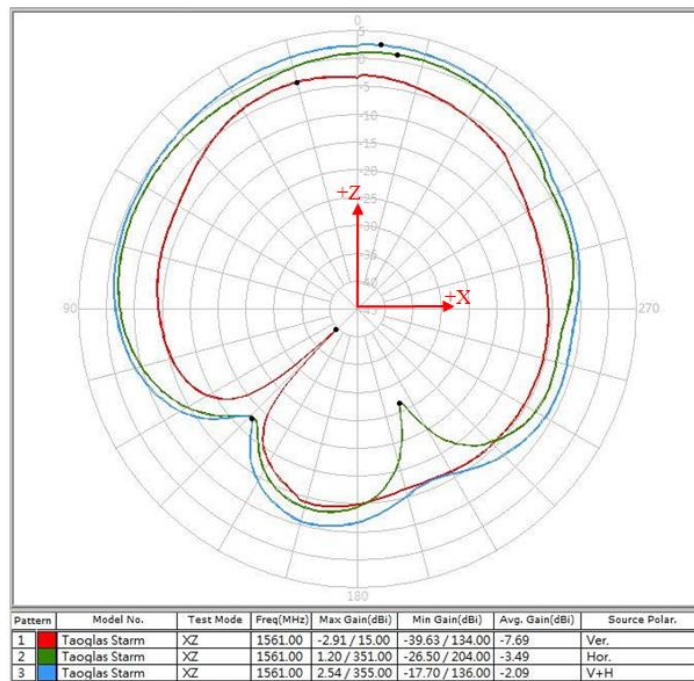

1561MHz		Peak Gain	Zenith Gain
V+H	XZ-Plane	2.54	2.19
	YZ-Plane	1.21	1.16

(dBi)

Radiation pattern @ 1575.42MHz

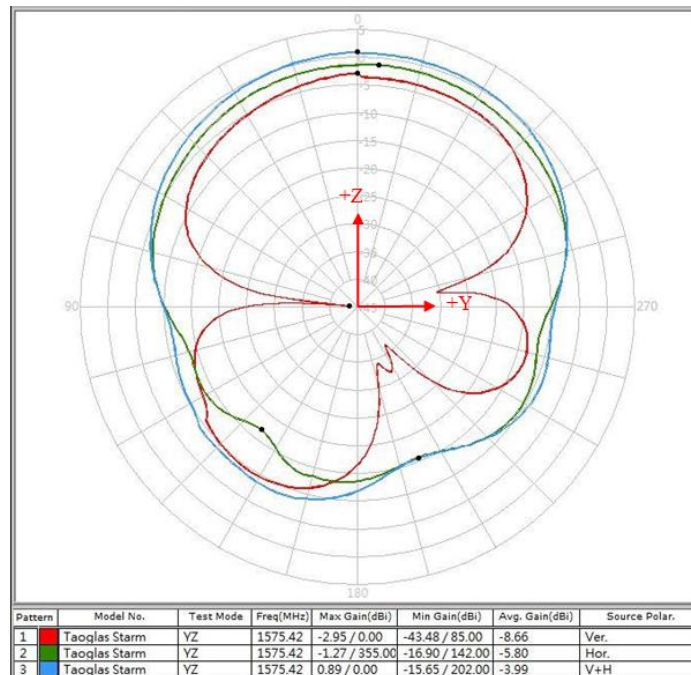
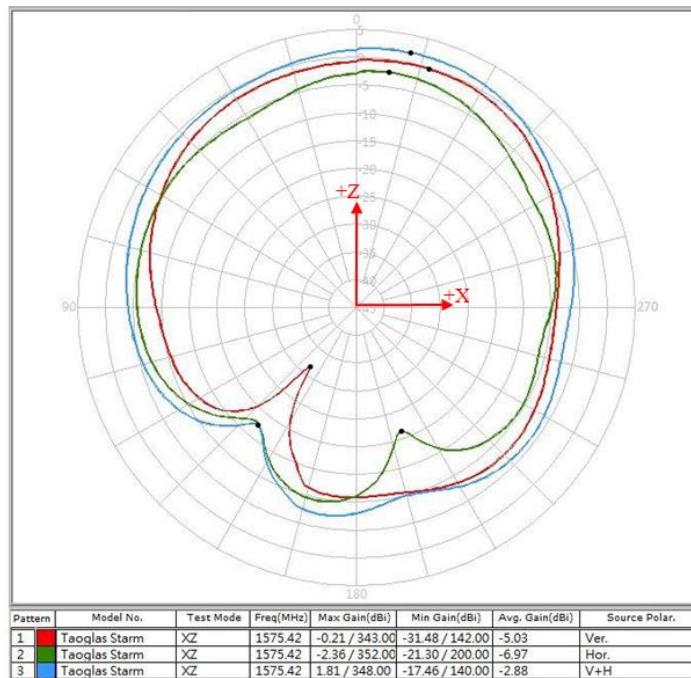

1575.42MHz		Peak Gain	Zenith Gain
V+H	XZ-Plane	1.81	1.25
	YZ-Plane	0.89	0.89

(dBi)

Radiation pattern @ 1602MHz

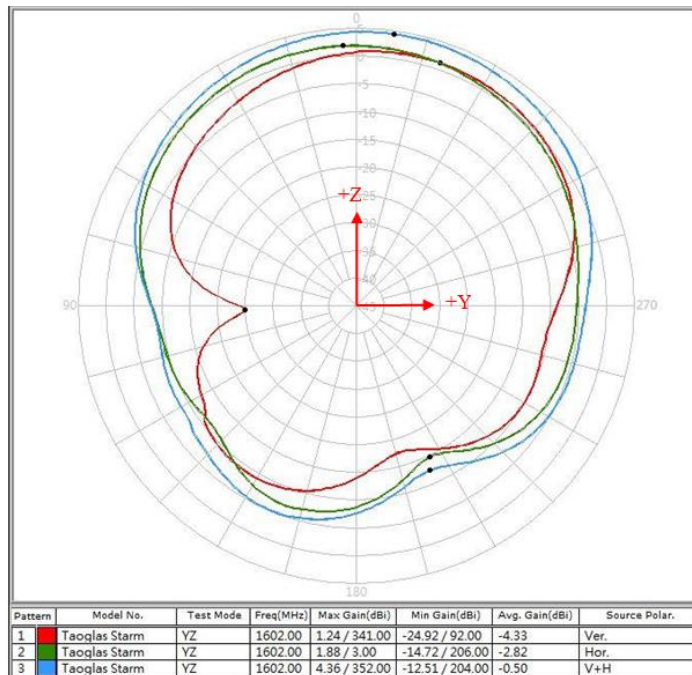
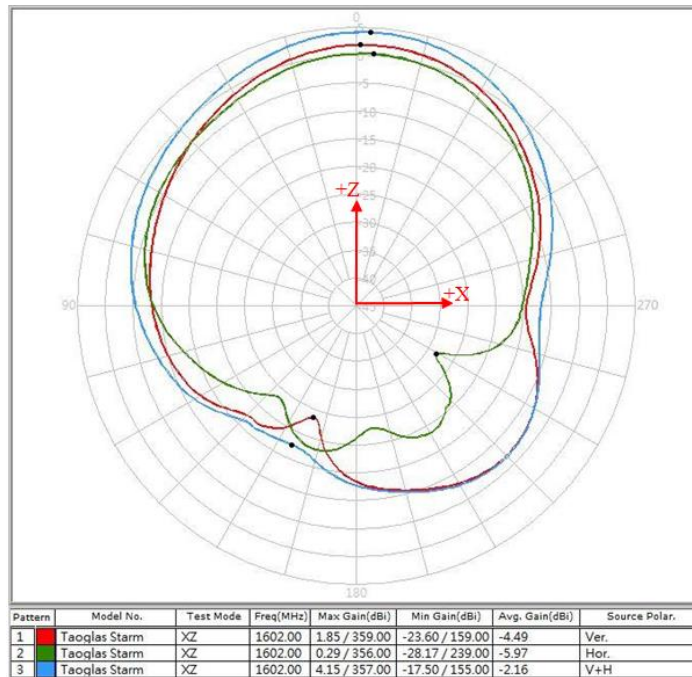



1602MHz		Peak Gain	Zenith Gain
V+H	XZ-Plane	4.15	4.08
	YZ-Plane	4.36	4.31

(dBi)

### 3.1.6 Axial Ratio Pattern

Frequency: 1561MHz

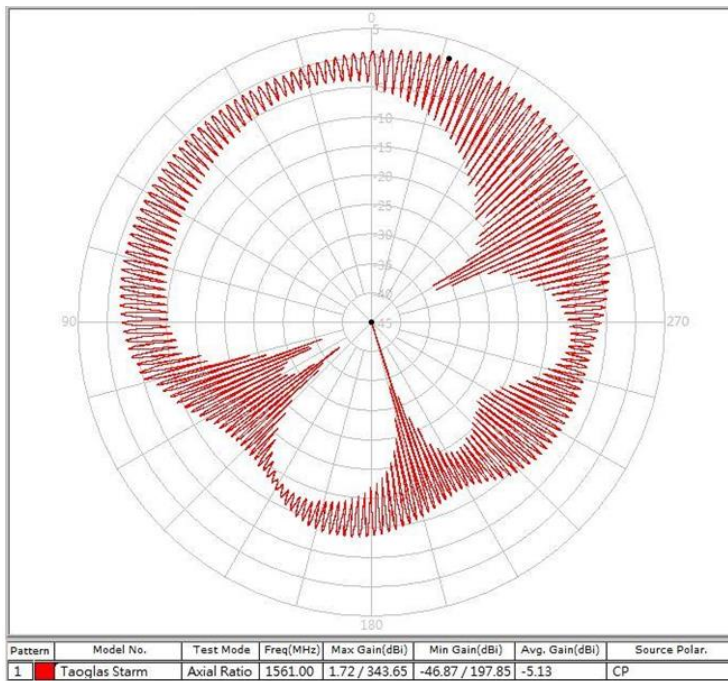

Angle	Axial Ratio
90°	8.03
75°	7.33
60°	6.74
45°	6.16
30°	4.45
15°	3.25
0°	4.93
345°	10.02
330°	14.36
315°	20.04
300°	31.37
285°	15.69
270°	5.79

Frequency: 1575.42MHz

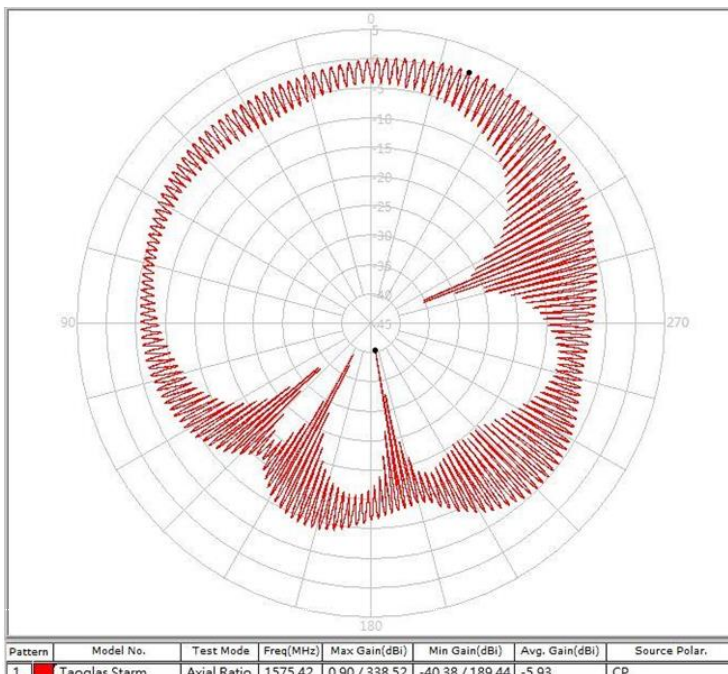

Angle	Axial Ratio
90°	2.89
75°	1.73
60°	2.57
45°	3.89
30°	4.88
15°	4.43
0°	2.77
345°	5.61
330°	8.09
315°	11.46
300°	19.67
285°	19.46
270°	8.11

Frequency: 1602MHz

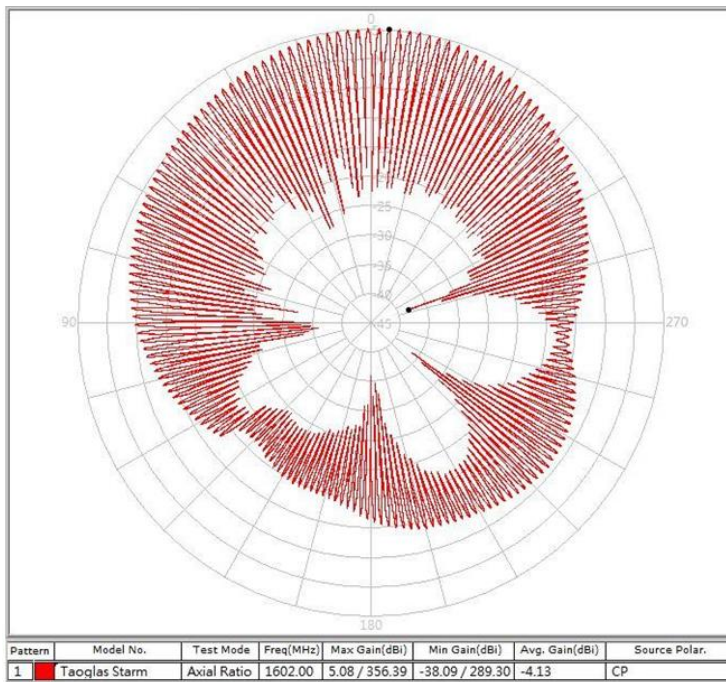

Angle	Axial Ratio
90°	29.65
75°	20.00
60°	22.48
45°	20.99
30°	25.20
15°	24.06
0°	10.14
345°	26.98
330°	24.1
315°	21.9
300°	19.5
285°	20.18
270°	4.5



### 3.1.7 BeiDou-GPS-GLONASS LNA Noise Figure

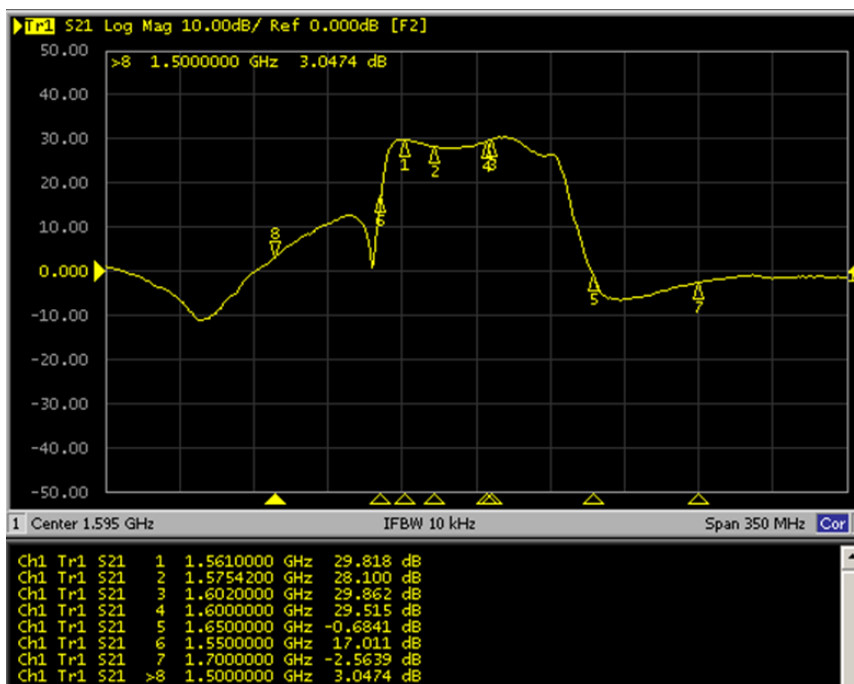

LNA Gain and Out Band Rejection @3.0V

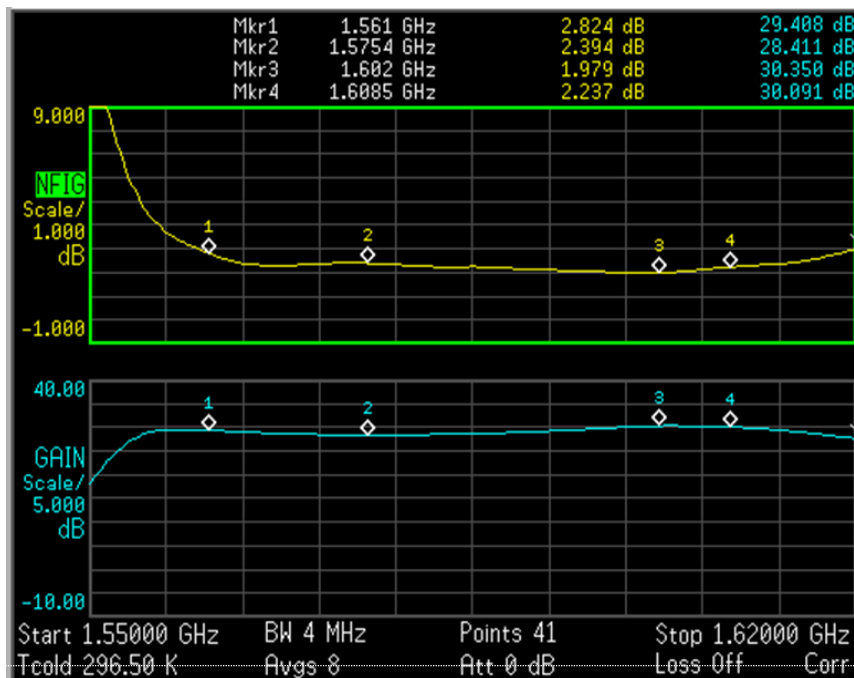

LNA Noise Figure @3.0V

## 3.2 LTE MIMO Antenna

### 3.2.1 Test Setup

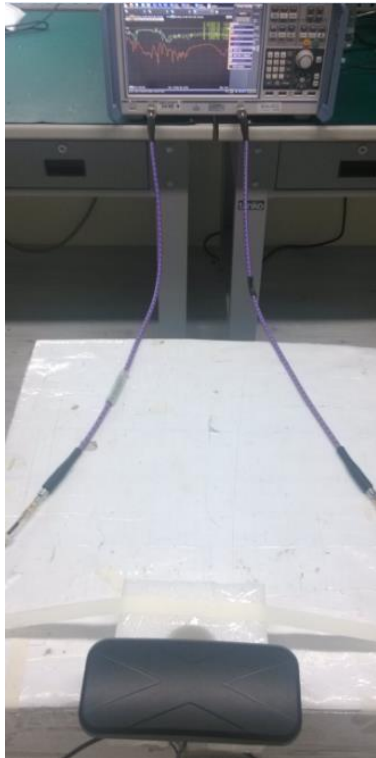

In free space

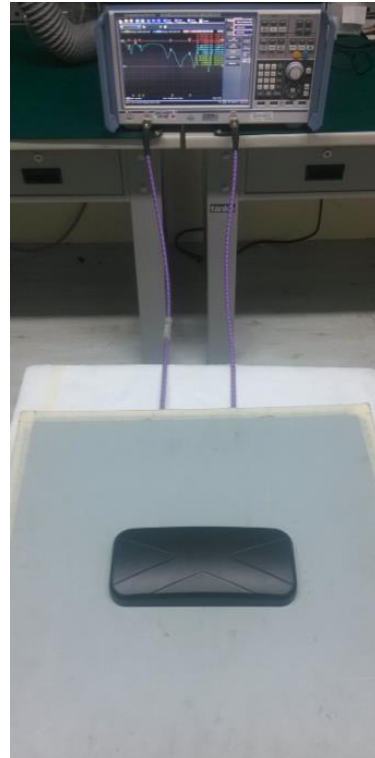

on the 50\*50cm ground plane

### 3.2.2 LTE Antenna Return Loss and Isolation

Setup on the 50\*50cm ground plane with 0.3 meter cable length

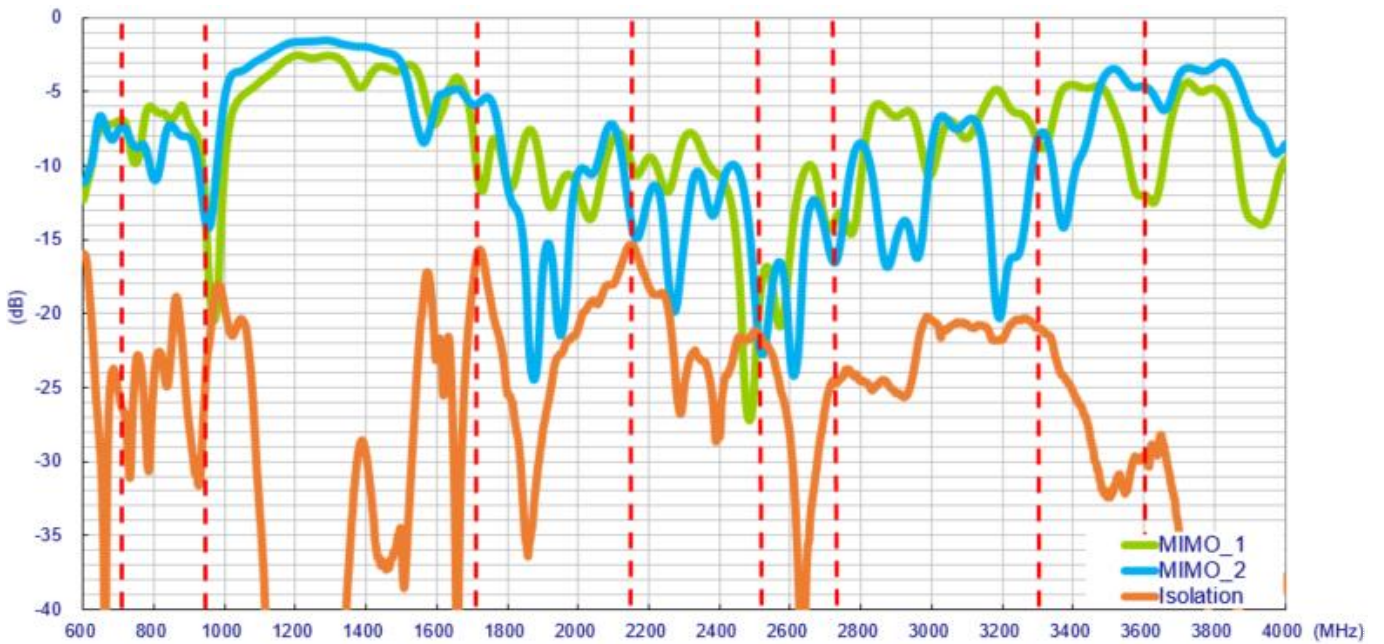

Setup in free space with 0.3 meter cable length

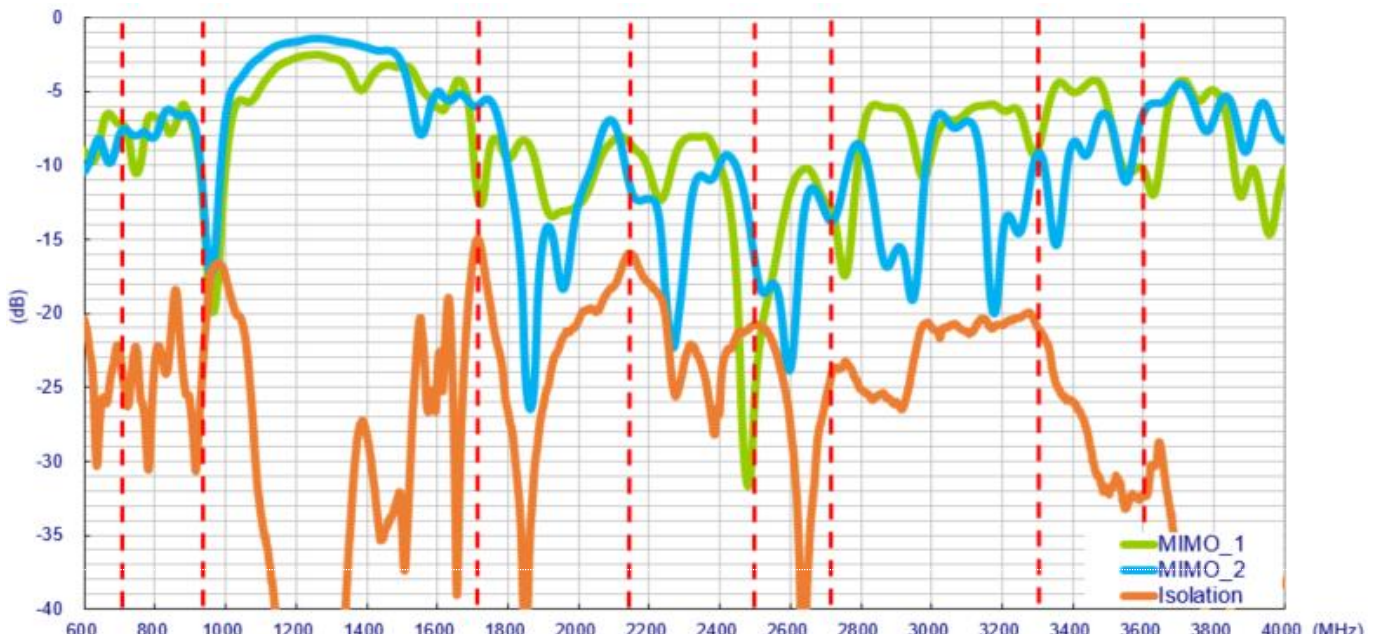

### 3.2.3 LTE Antenna Efficiency

Setup on the 50\*50cm ground plane with 0.3 meter cable length

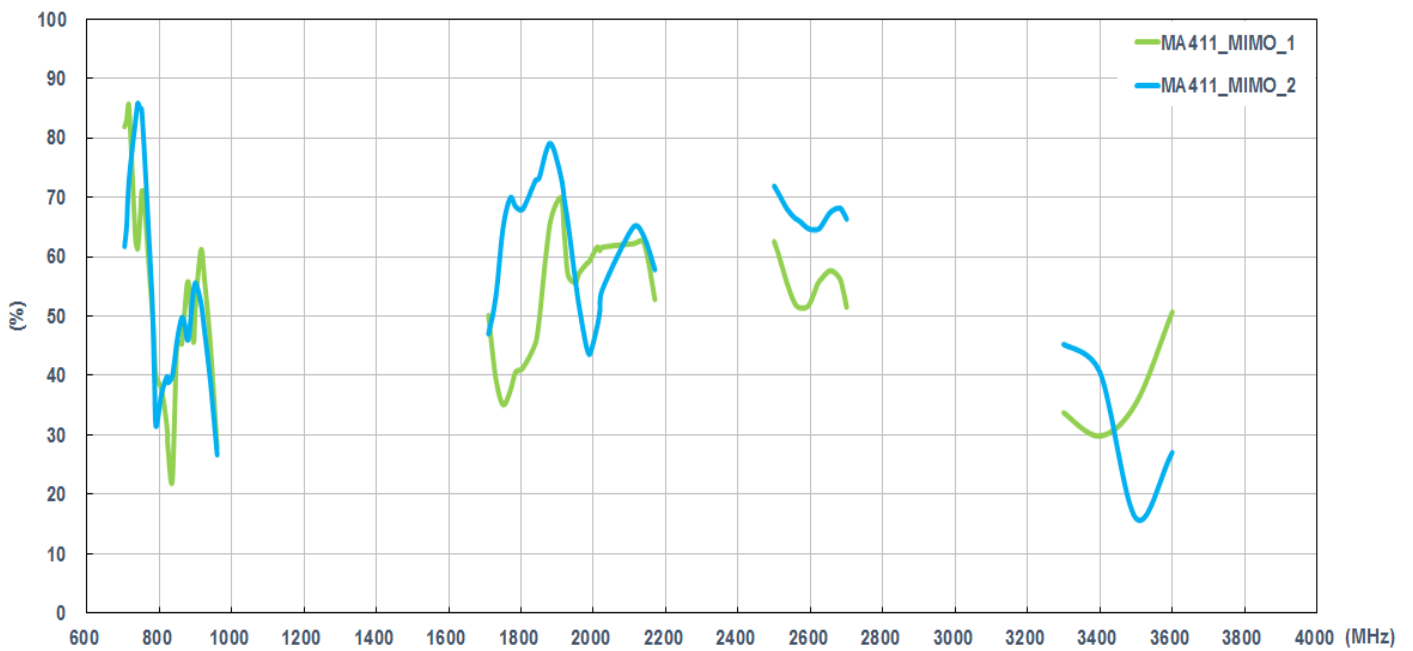

Setup in free space with 0.3 meter cable length

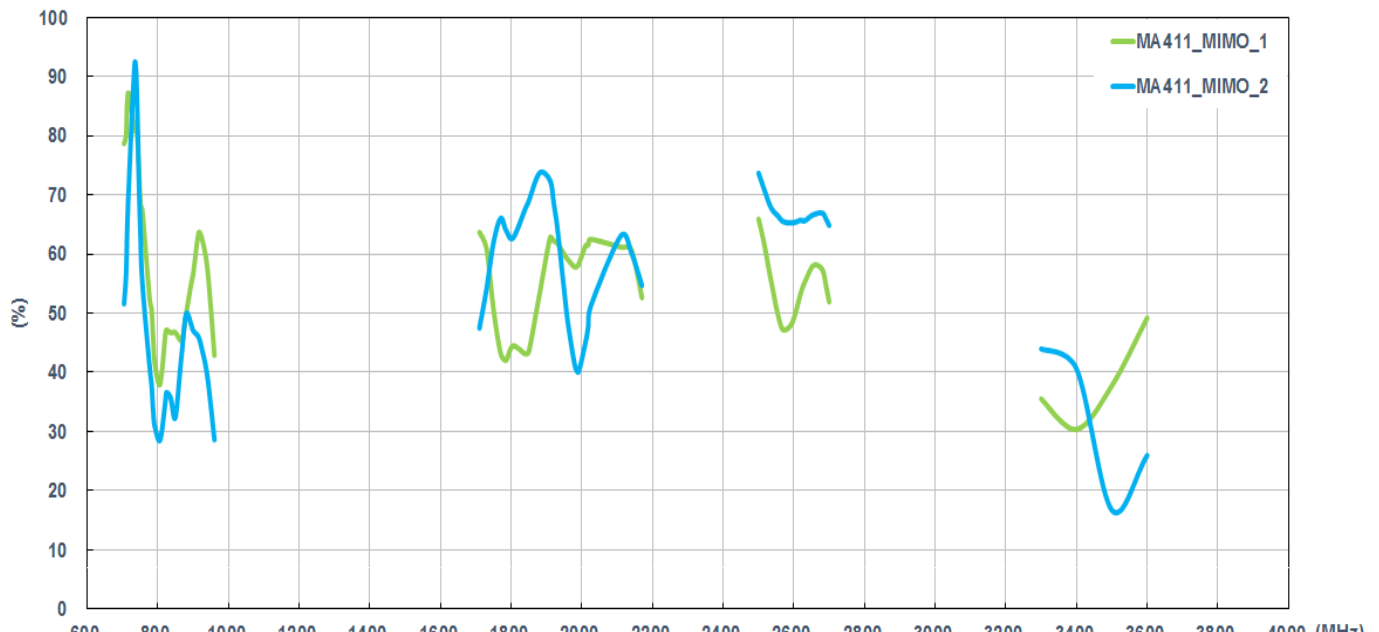

### 3.2.4 LTE Antenna Peak Gain

Setup on the 50\*50cm ground plane with 0.3 meter cable length

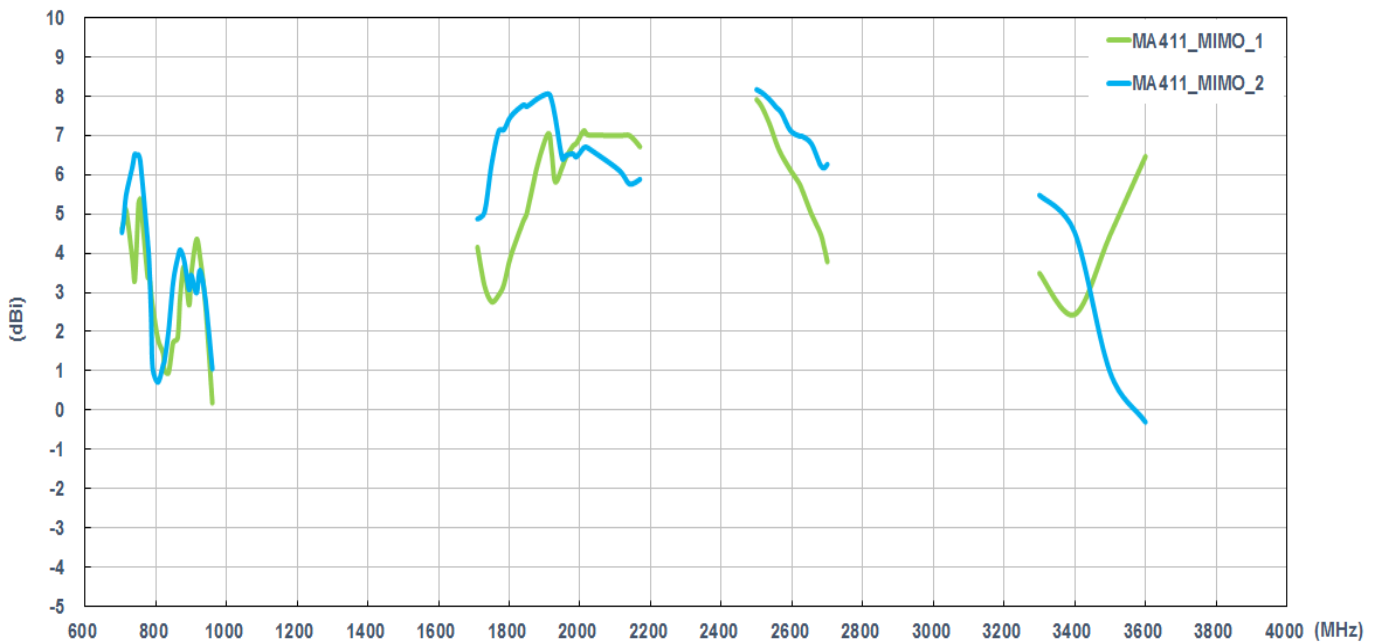

Setup in free space with 0.3 meter cable length

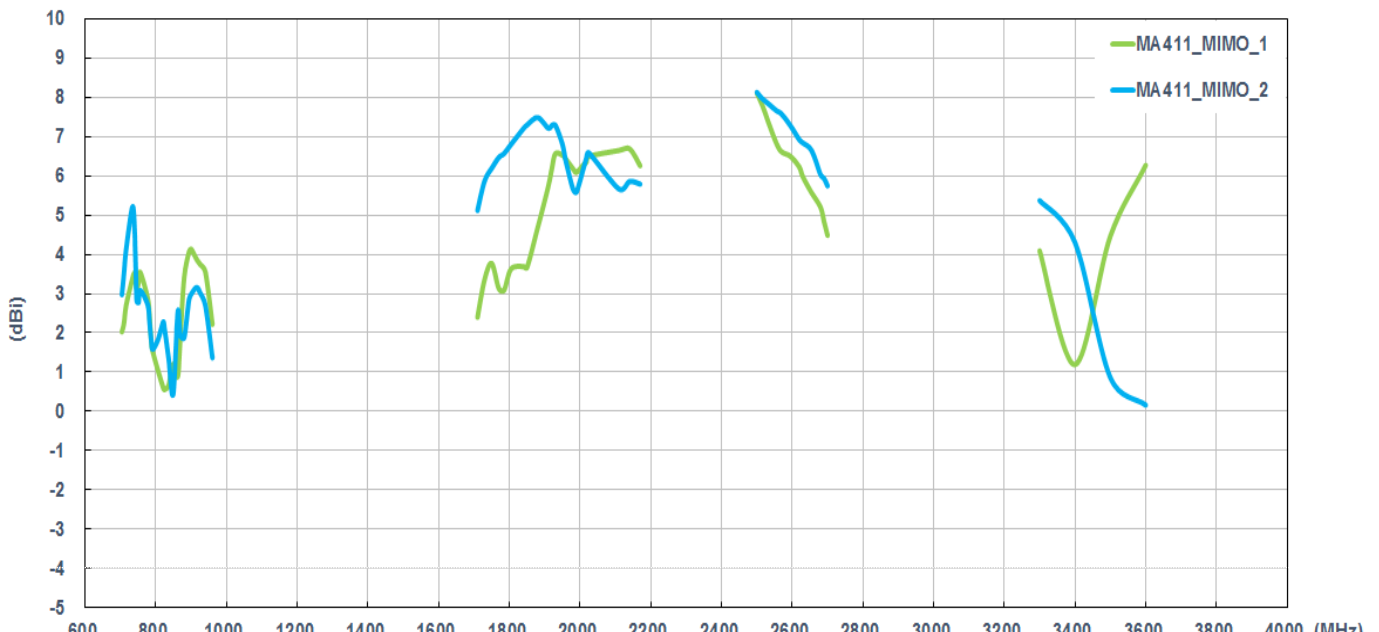

### 3.2.5 LTE Antenna Average gain

Setup on the 50\*50cm ground plane with 0.3 meter cable length

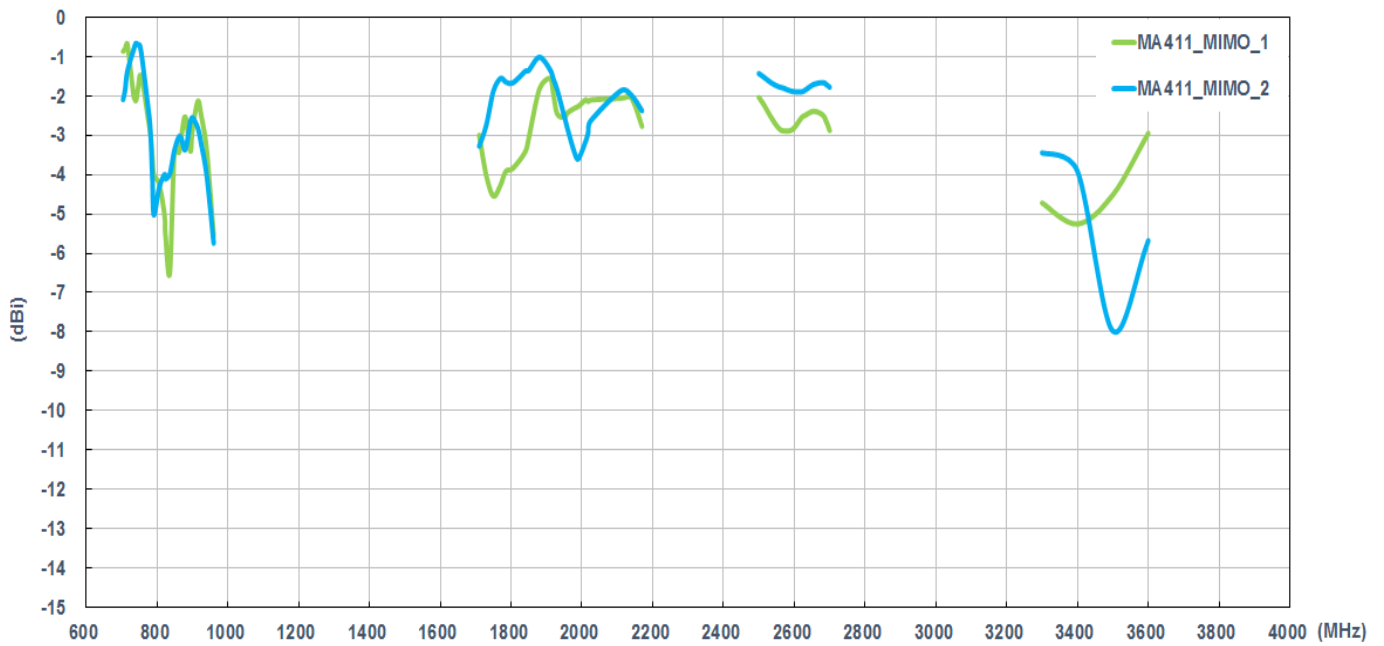

Setup in free space with 0.3 meter cable length

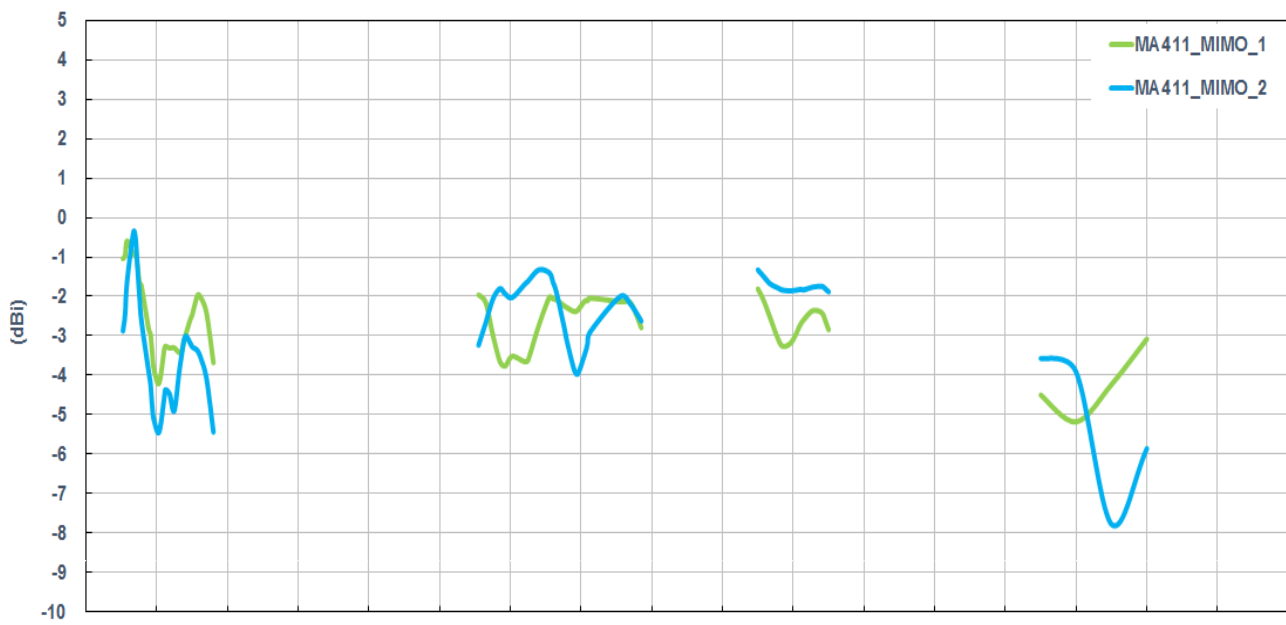

### 3.2.6 Test Setup For Antenna Radiation Pattern (ETS Anechoic chamber)

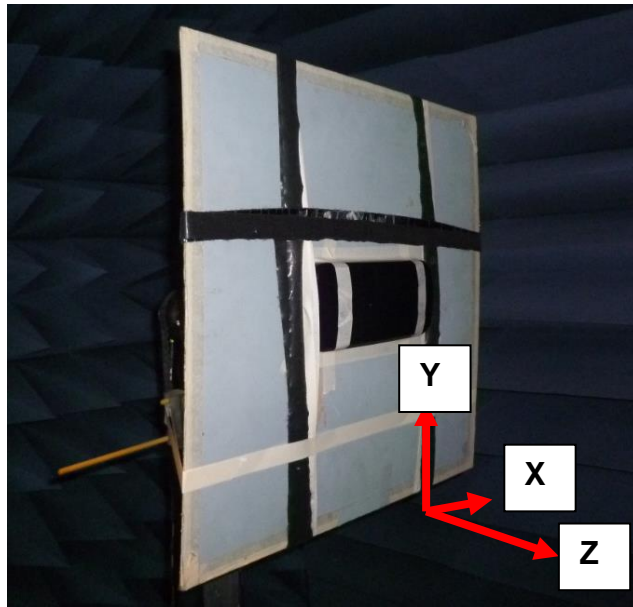

**On the 50\*50cm ground plane**

### 3.2.7 2D Radiation pattern (MIMO1 with 0.3M cable length on the 50\*50 ground plane)

XY Plane

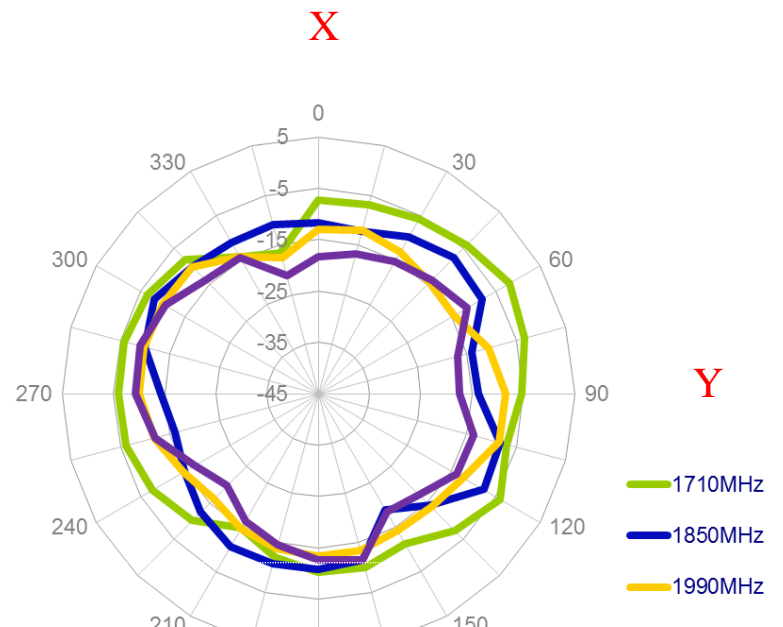
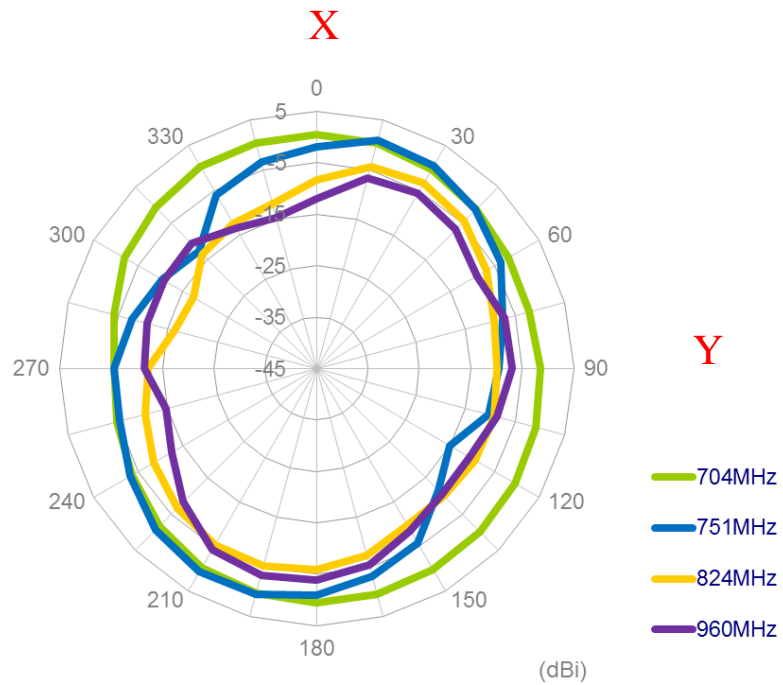



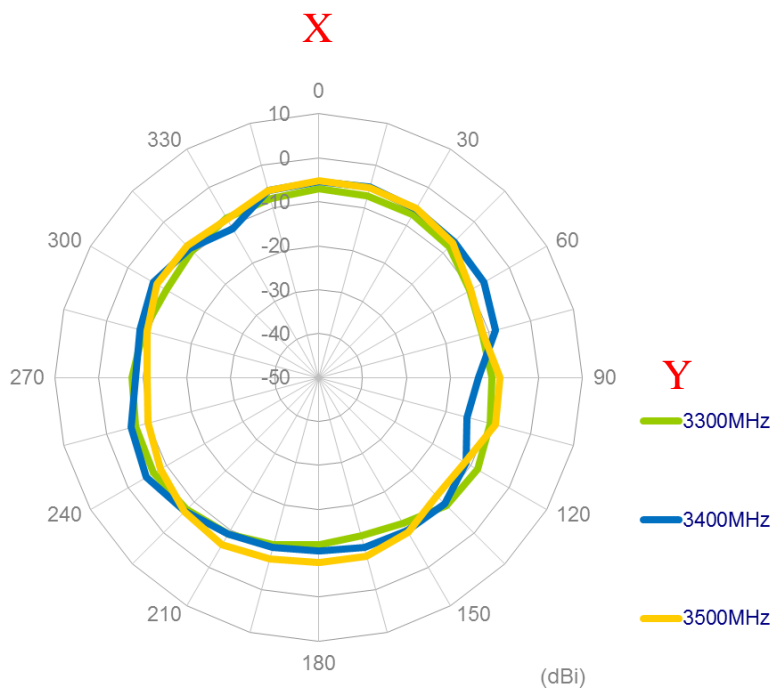
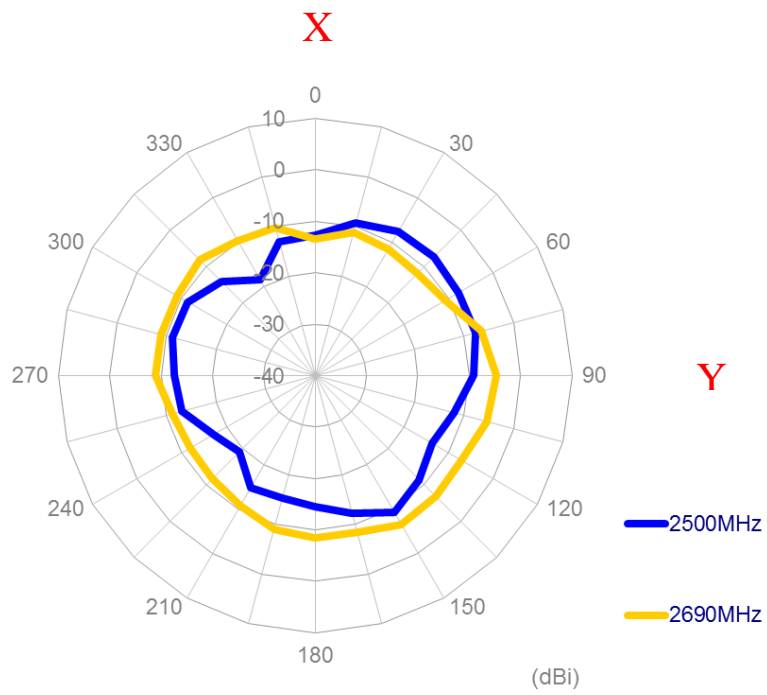



XZ Plane

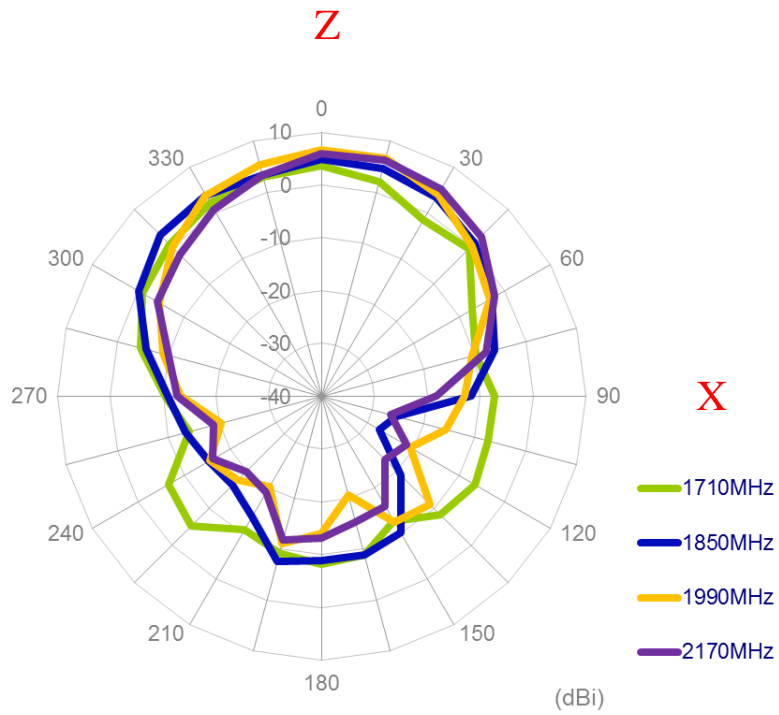
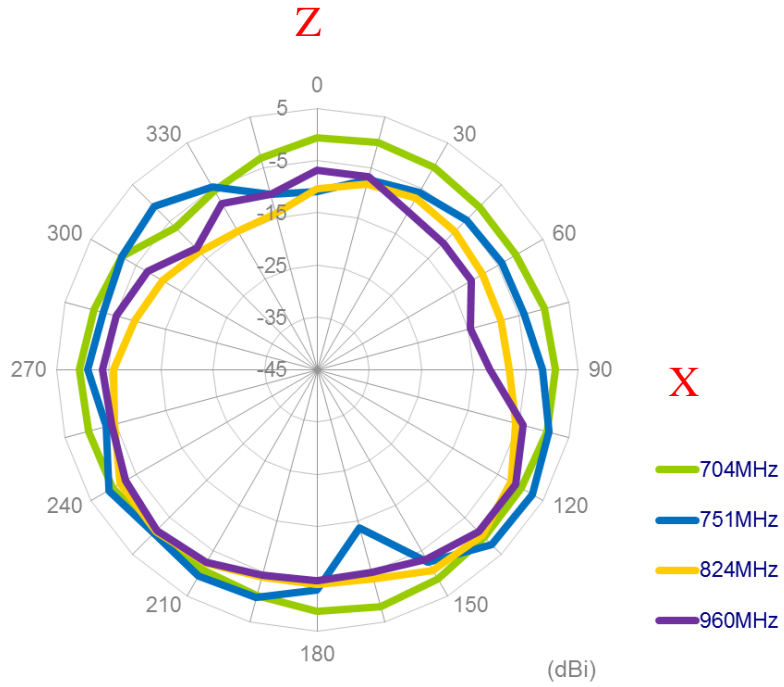

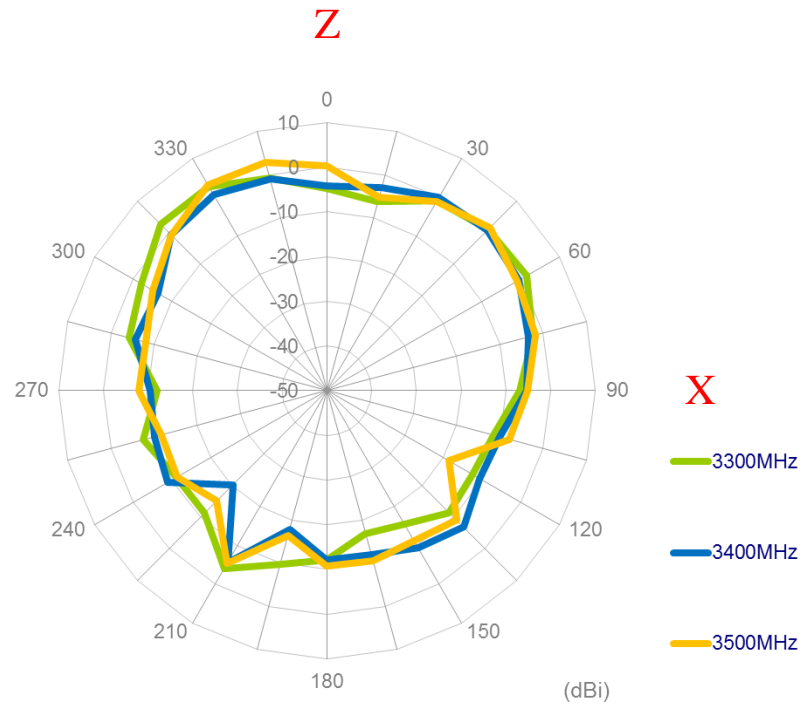
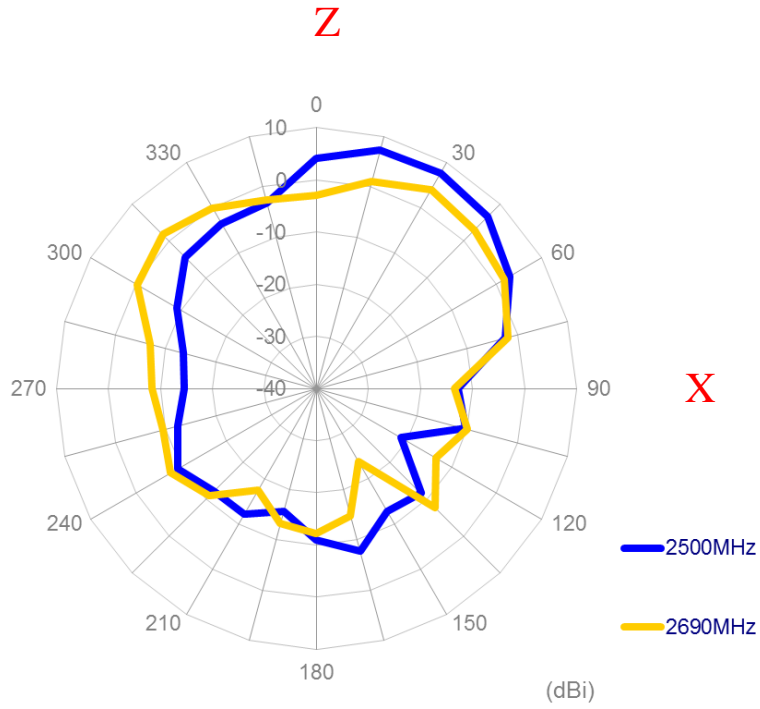

YZ Plane

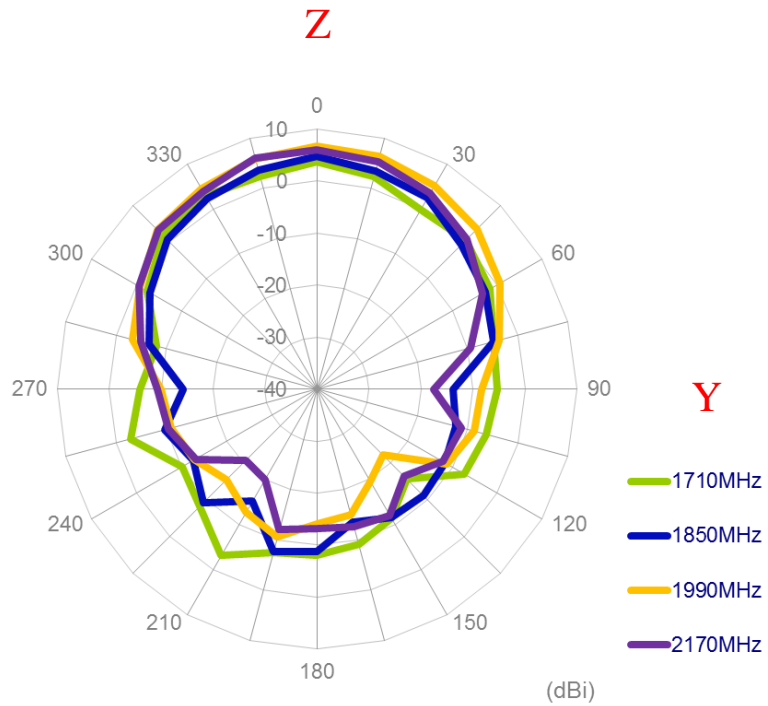
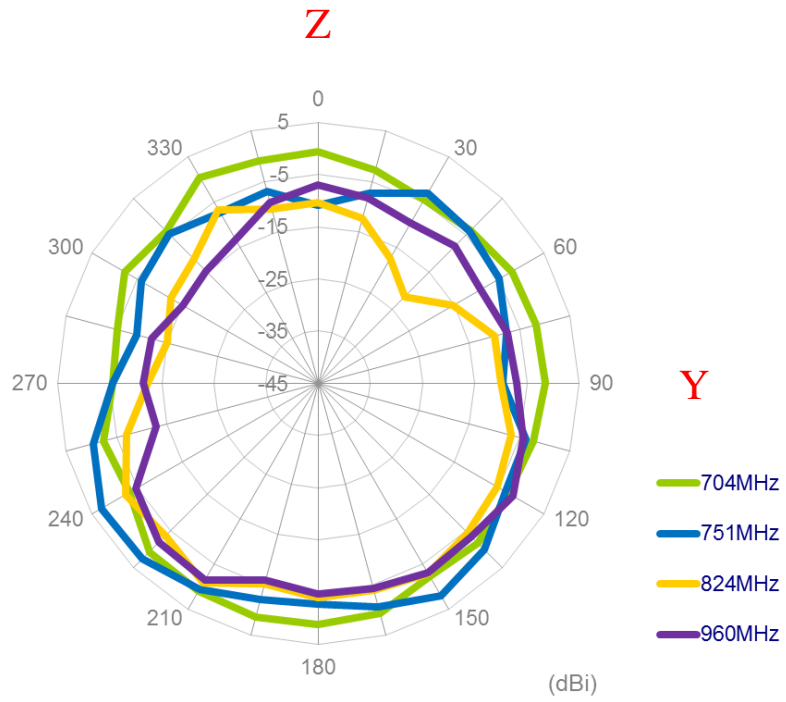

Z

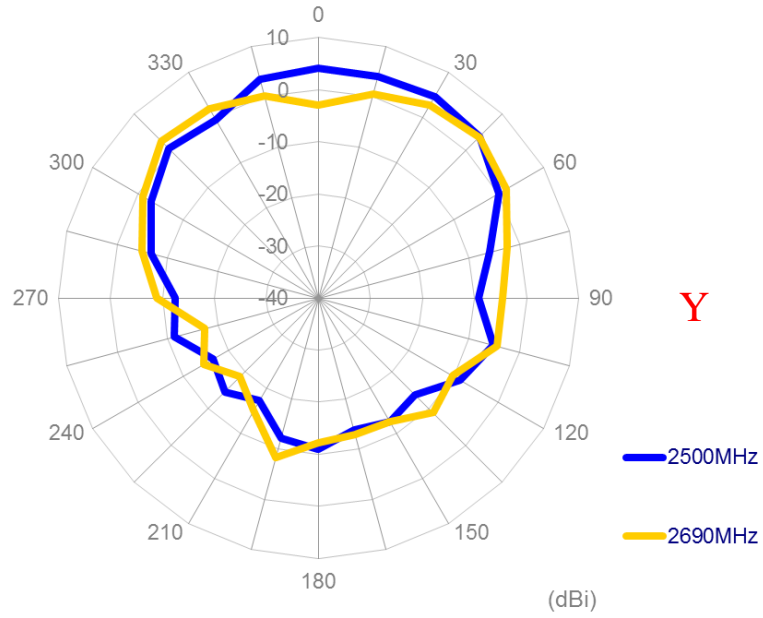

Z

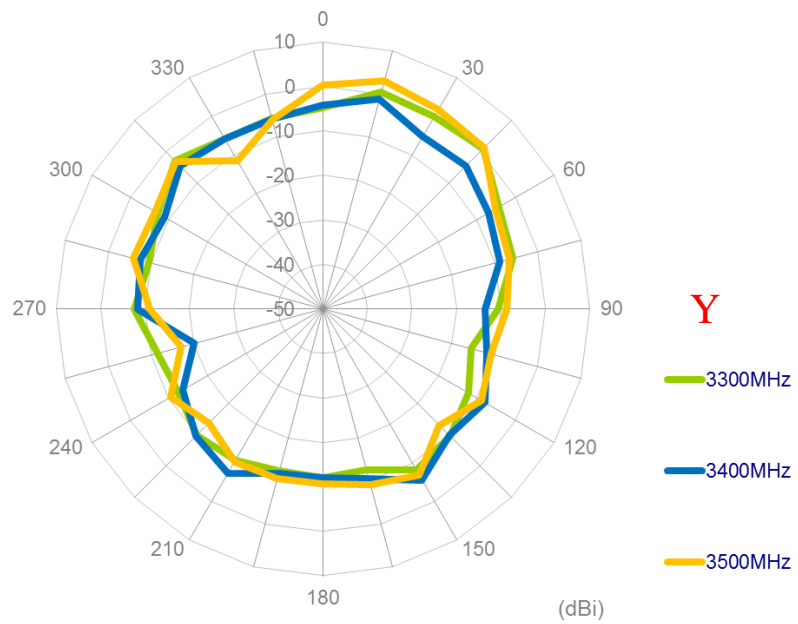

### 3.2.8 3D Radiation pattern (MIMO1 with 0.3M cable length on the 50\*50 ground plane)

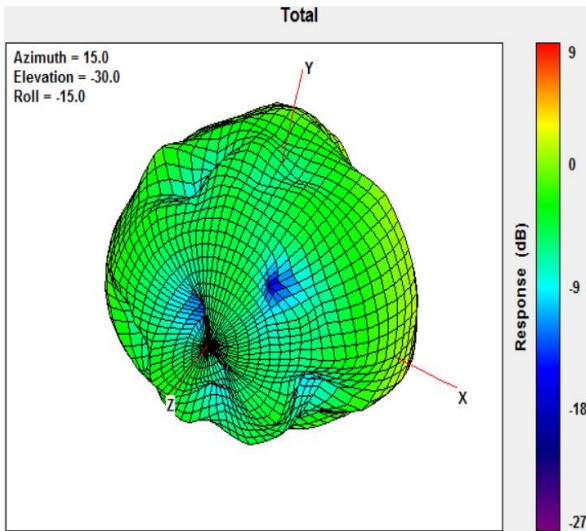

704MHz

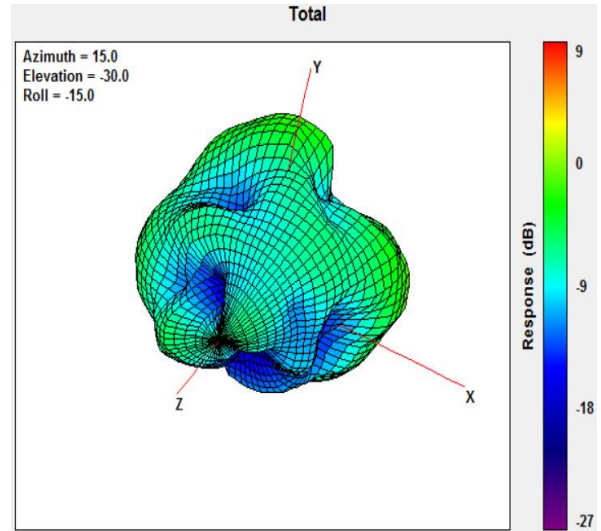

960MHz

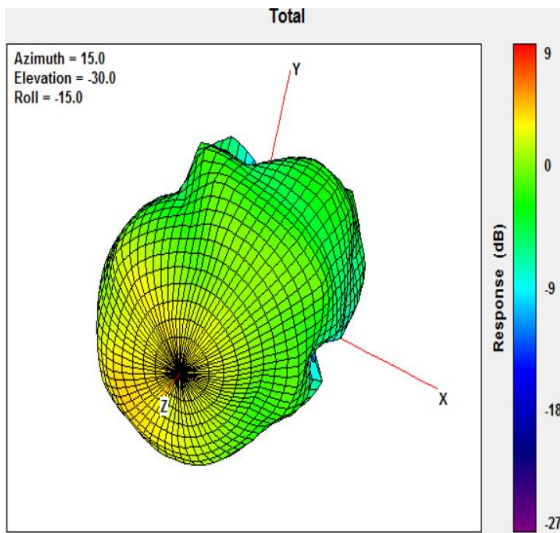

1710MHz

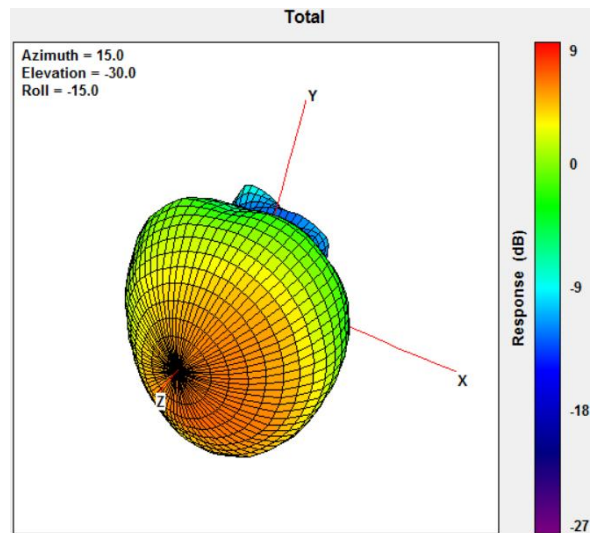

2170MHz

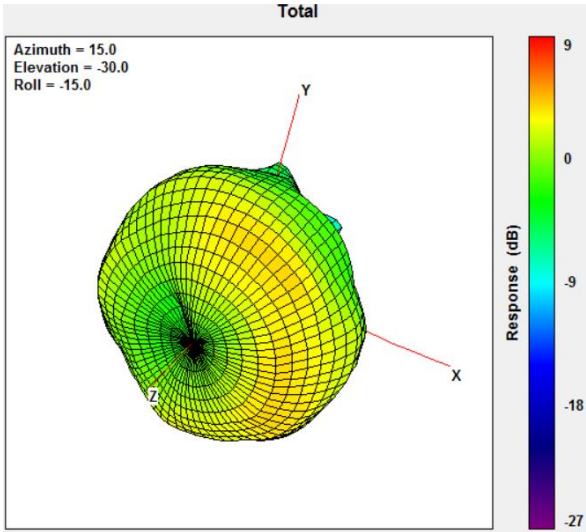

2690MHz

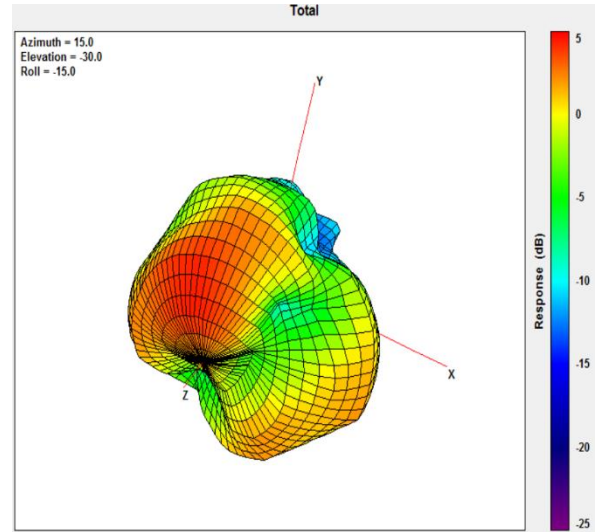

3500MHz



### 3.2.9 2D Radiation pattern (MIMO2 with 0.3M cable length on the 50\*50 ground plane)

XY Plane

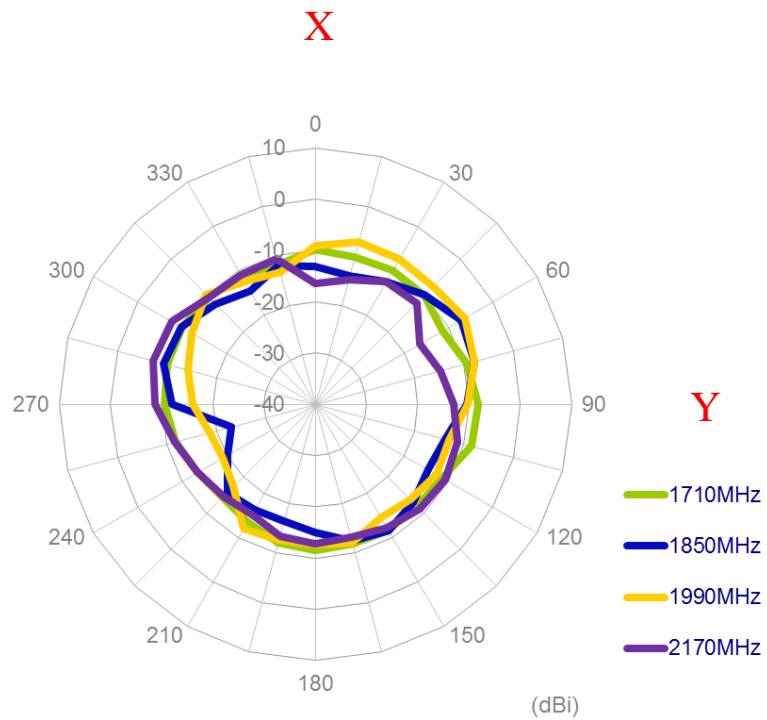
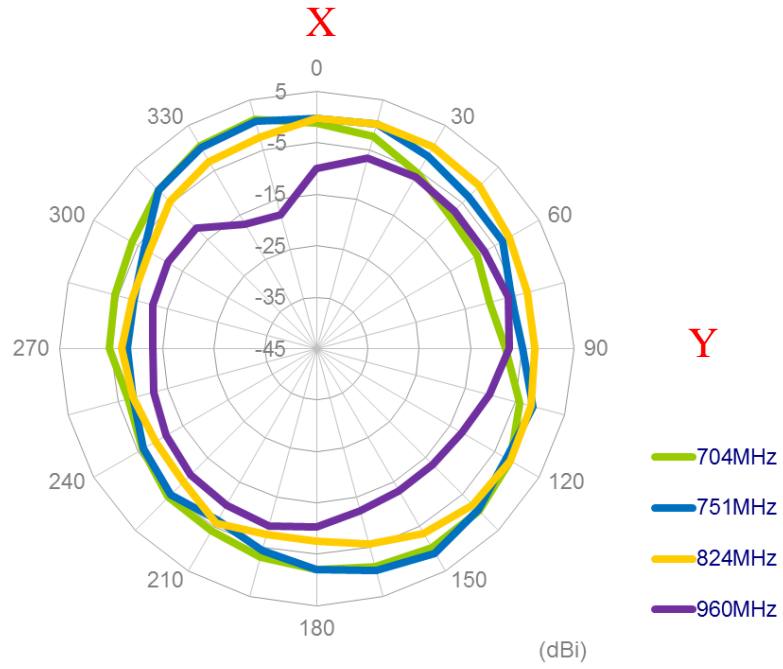

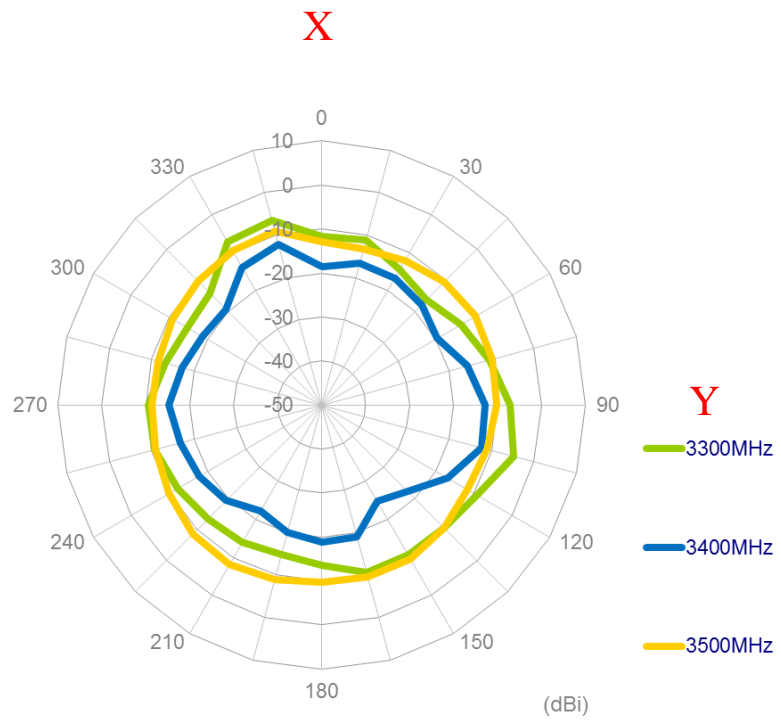
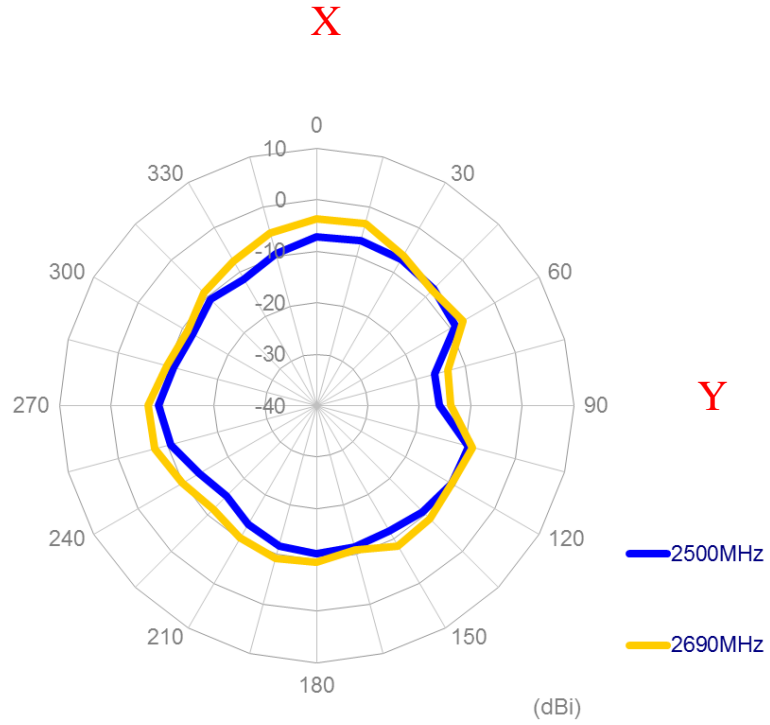

XZ Plane

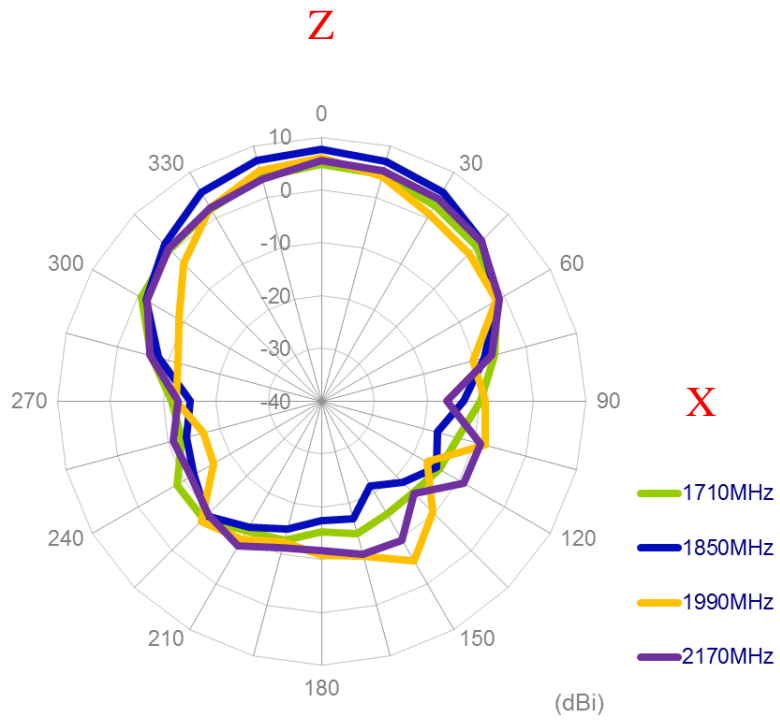
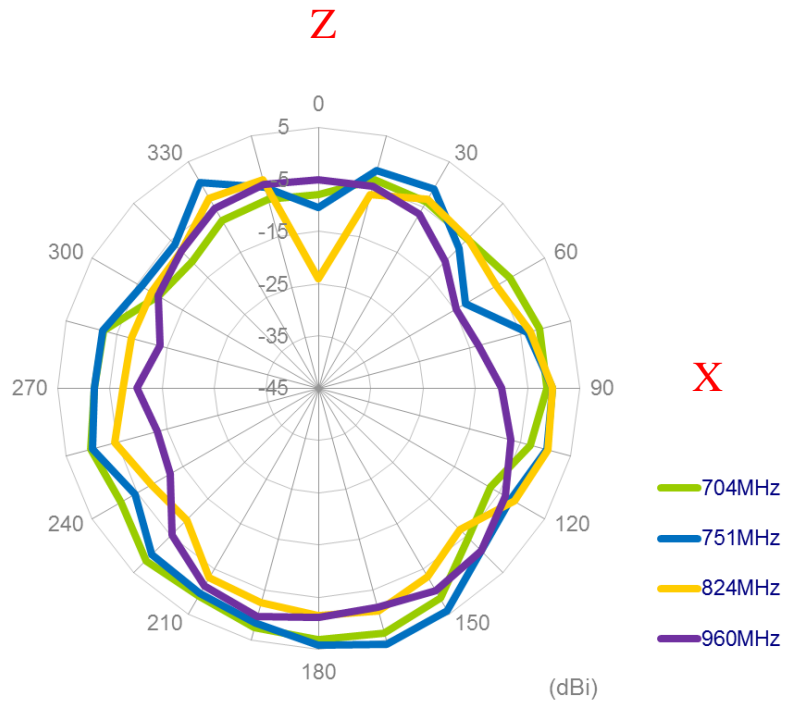

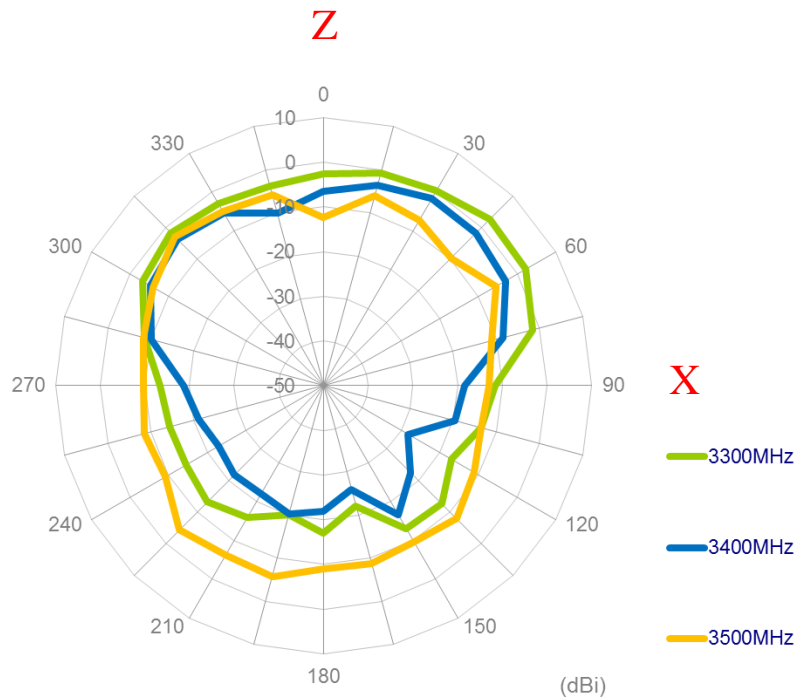
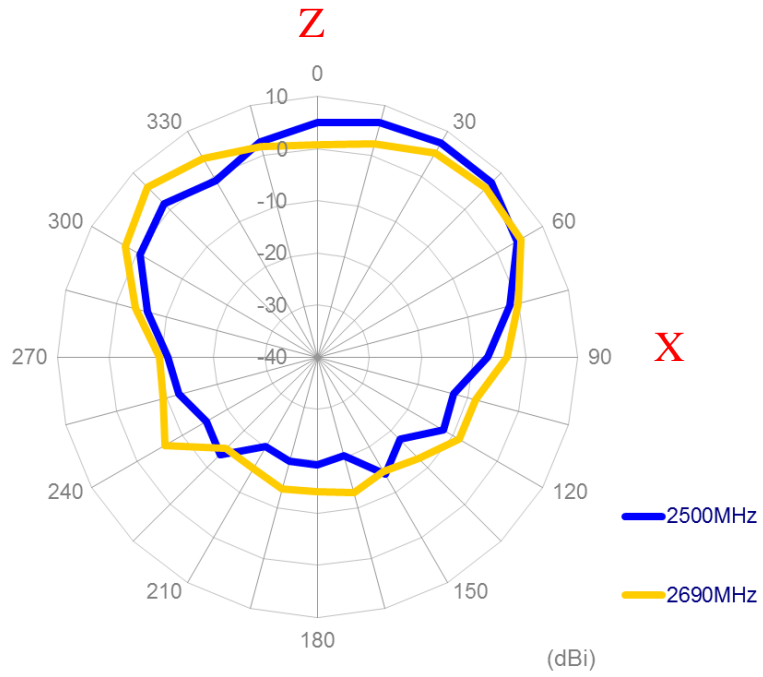

YZ Plane

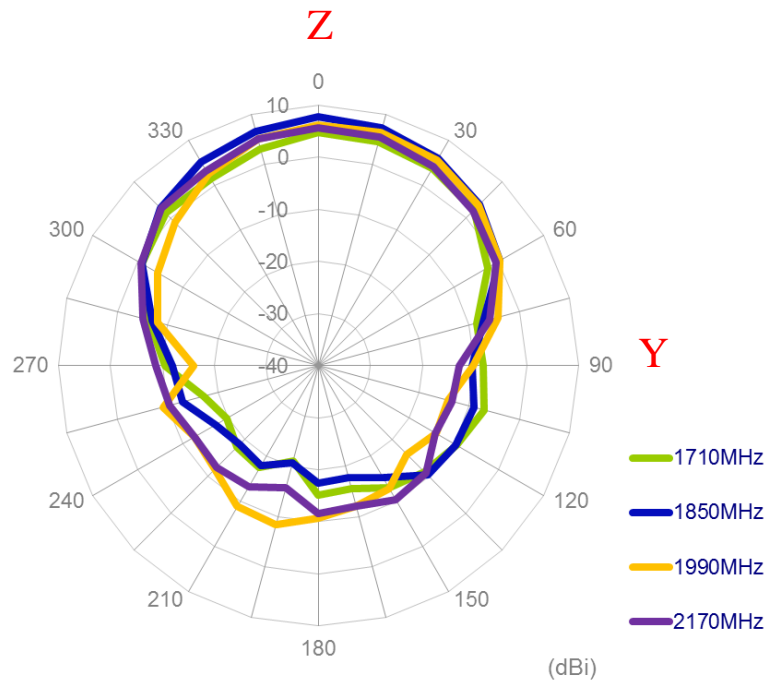
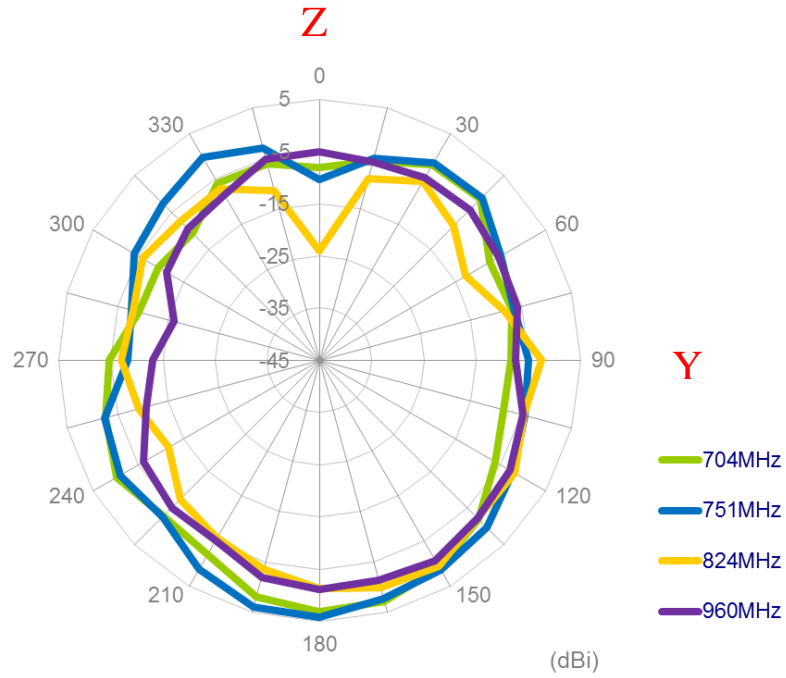

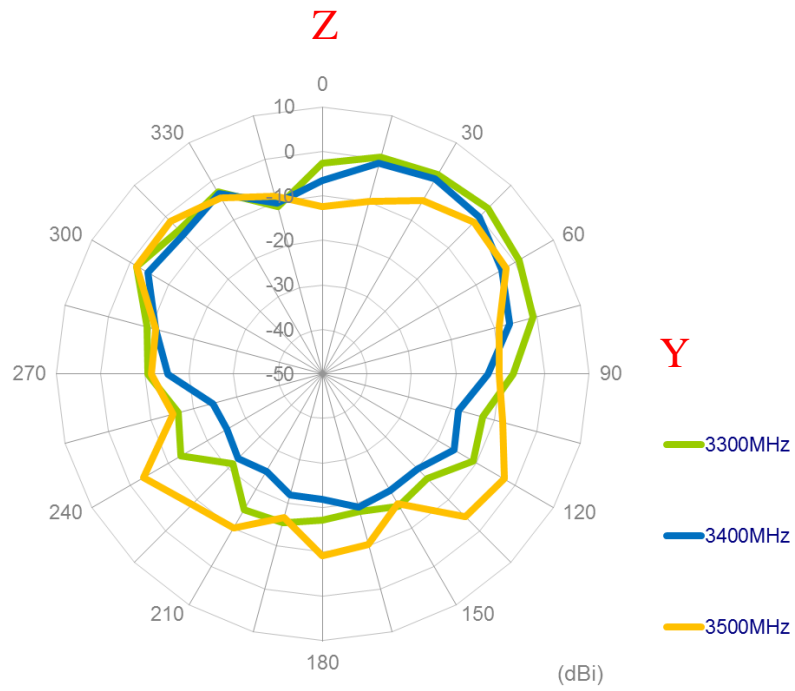
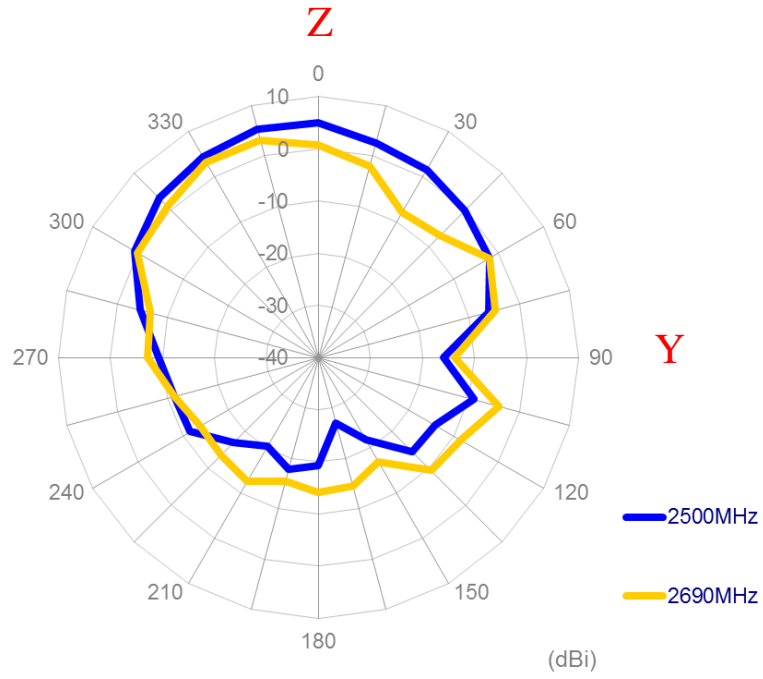

### 3.2.10 3D Radiation pattern (MIMO2 with 0.3M cable length on the 50\*50 ground plane)

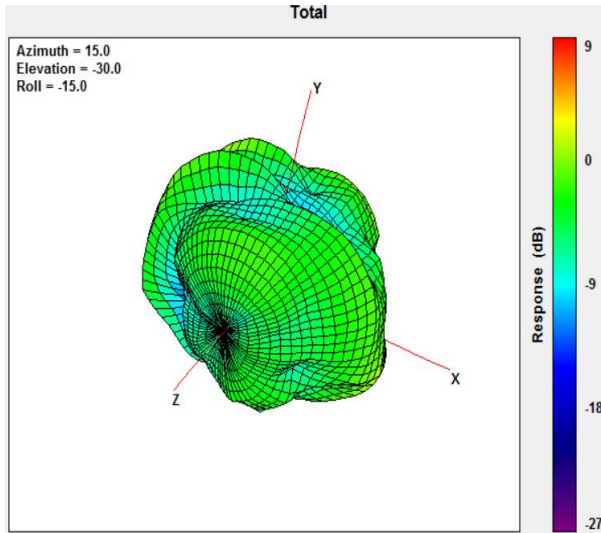

704MHz

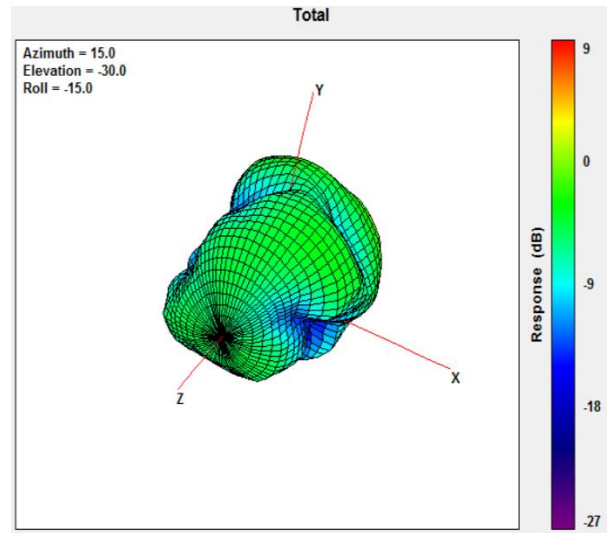

960MHz

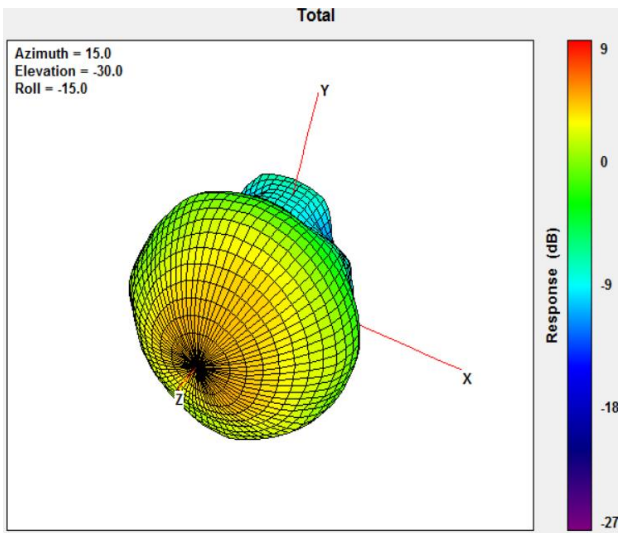

1710MHz

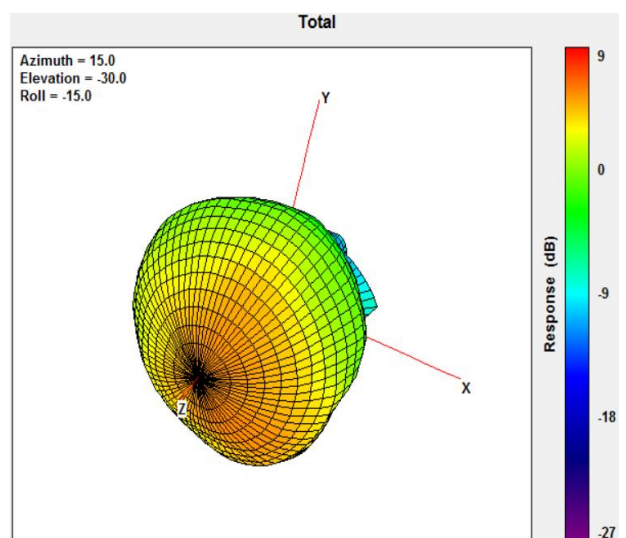

2170MHz

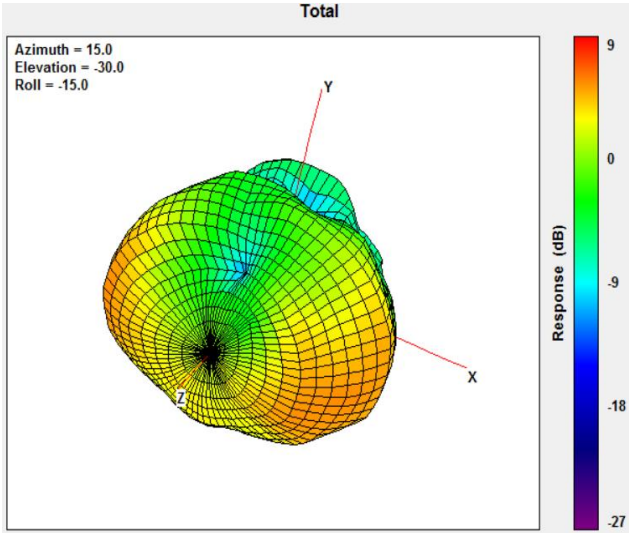

2690MHz

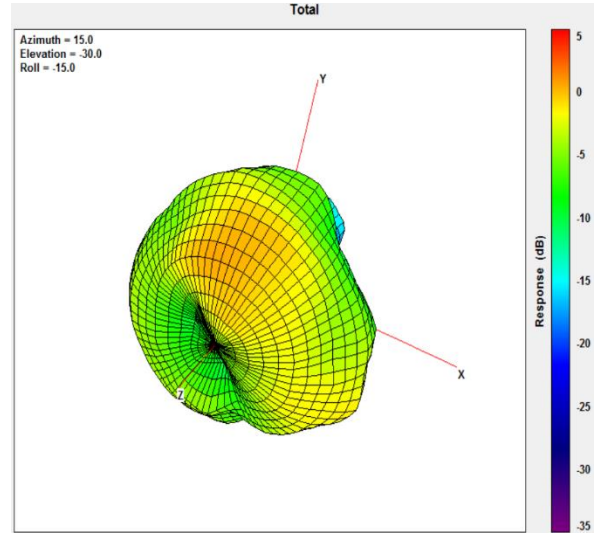

3500MHz



### 3.2.11 Test Setup For Antenna Radiation Pattern (ETS Anechoic chamber)

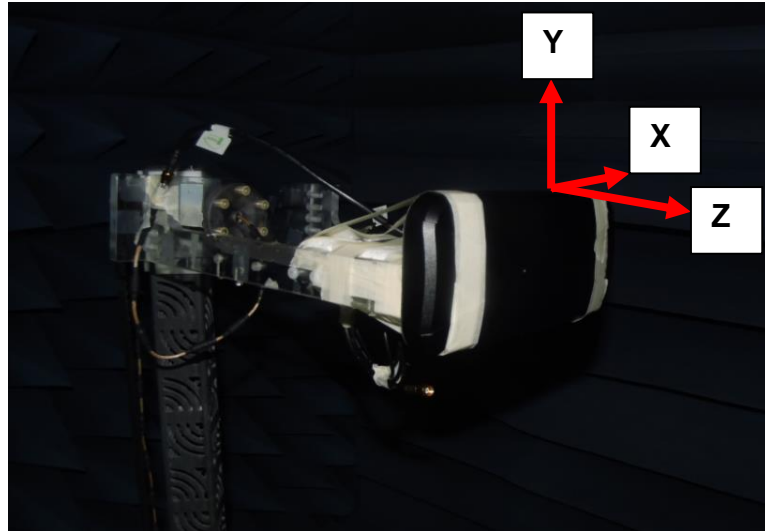

**In free space**

### 3.2.12 2D Radiation pattern (MIMO1 with 0.3M cable length in free space)

XY Plane

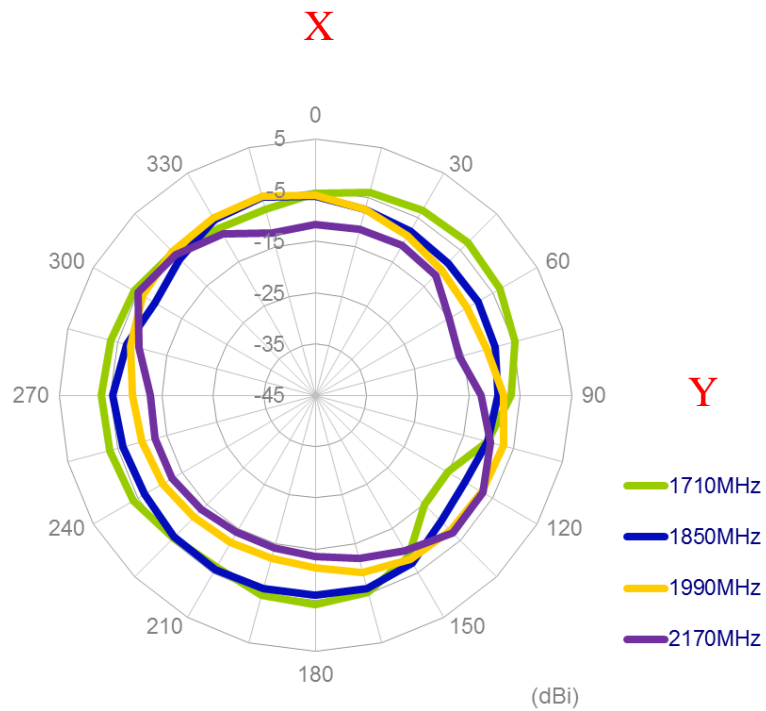
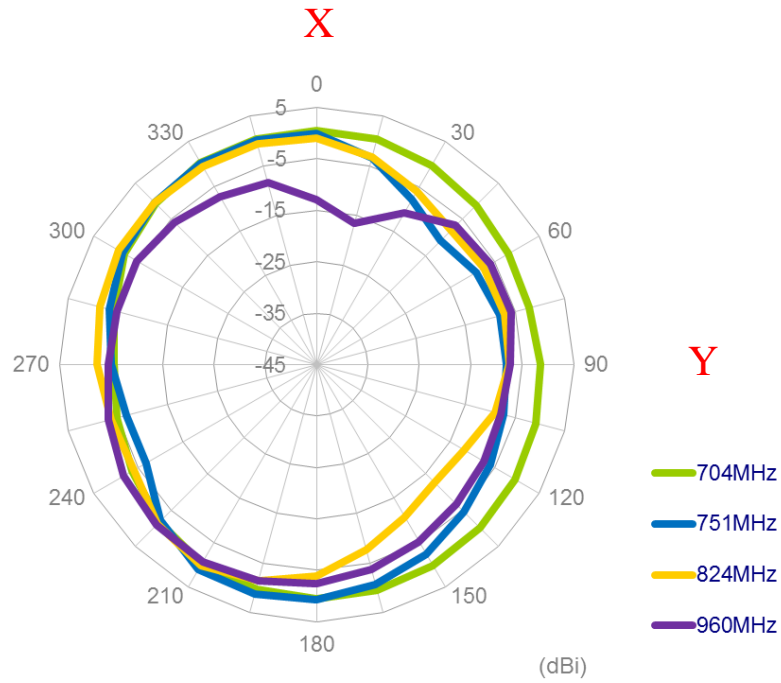

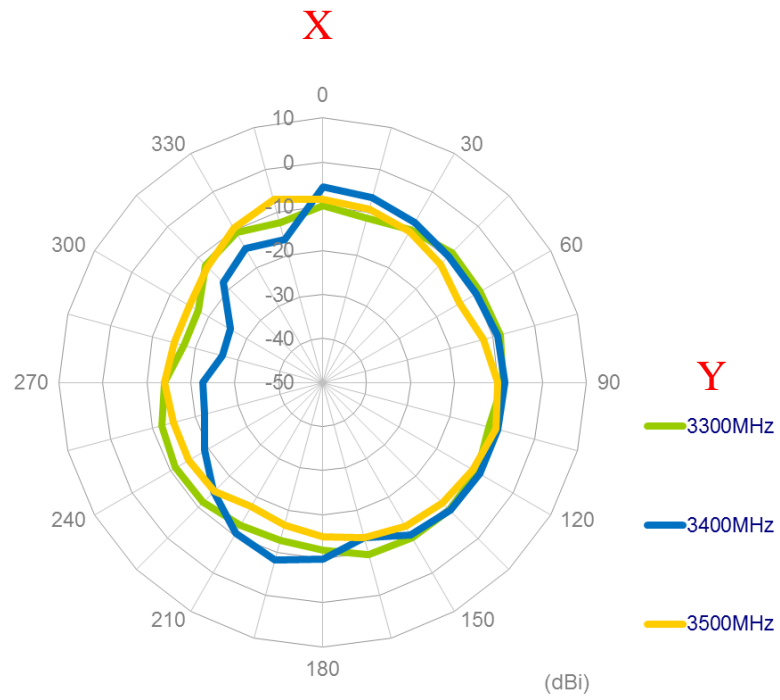
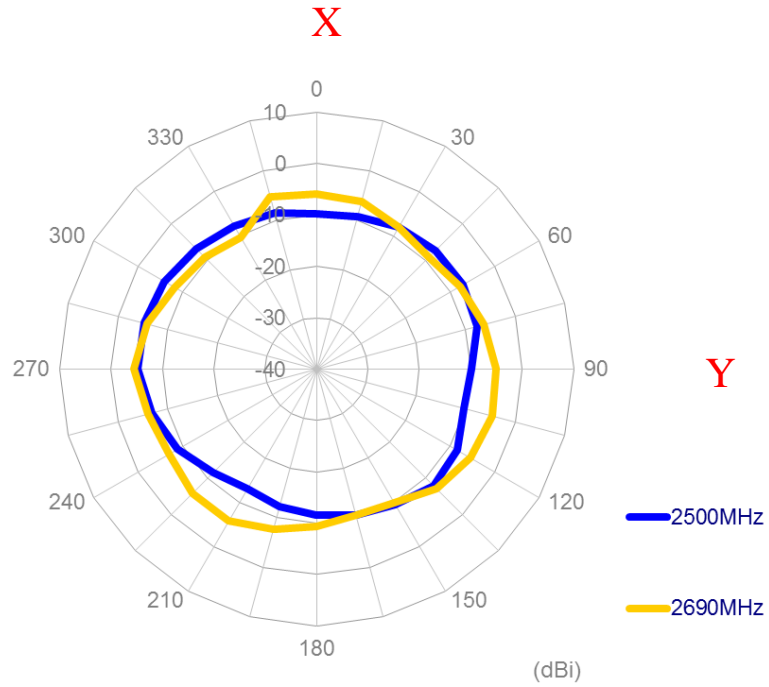

XZ Plane

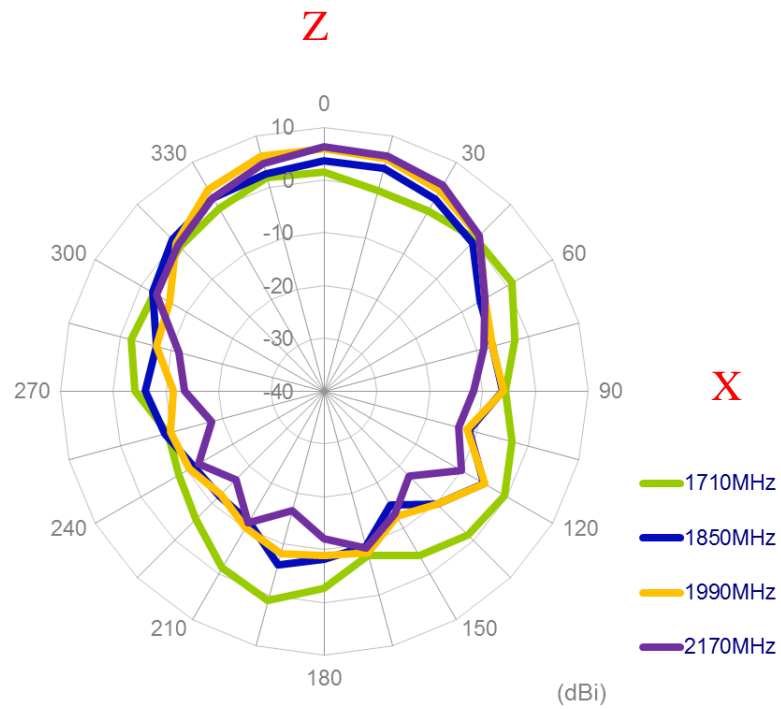
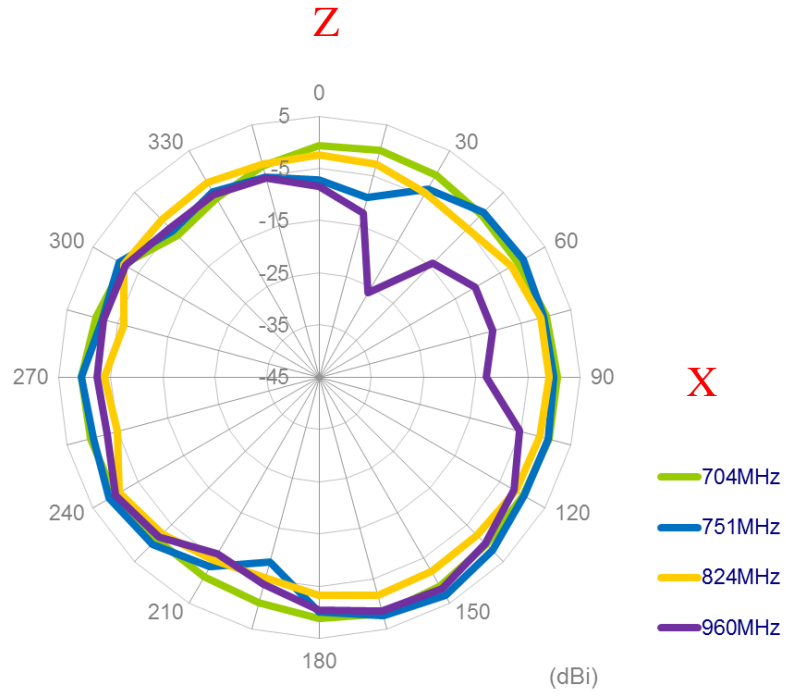

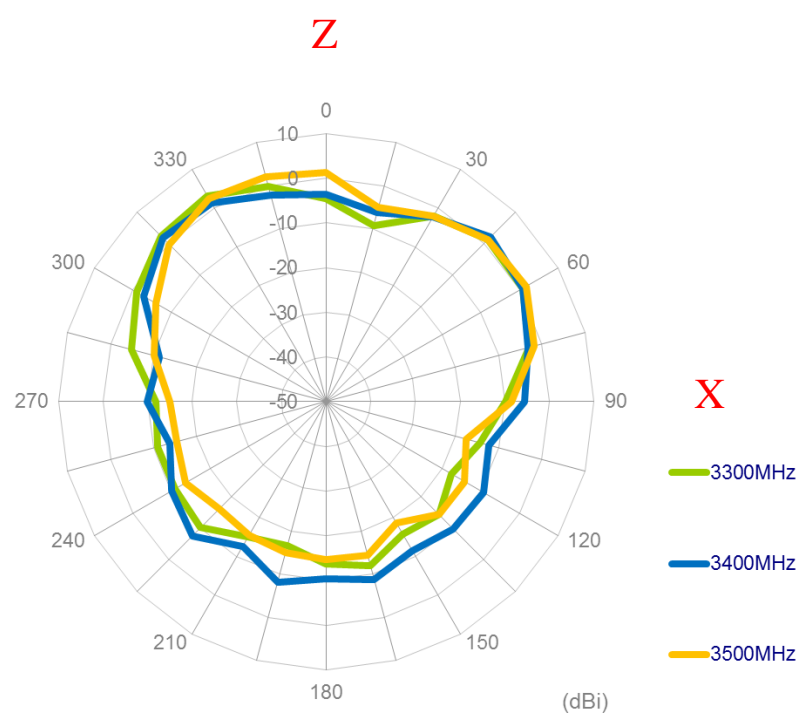
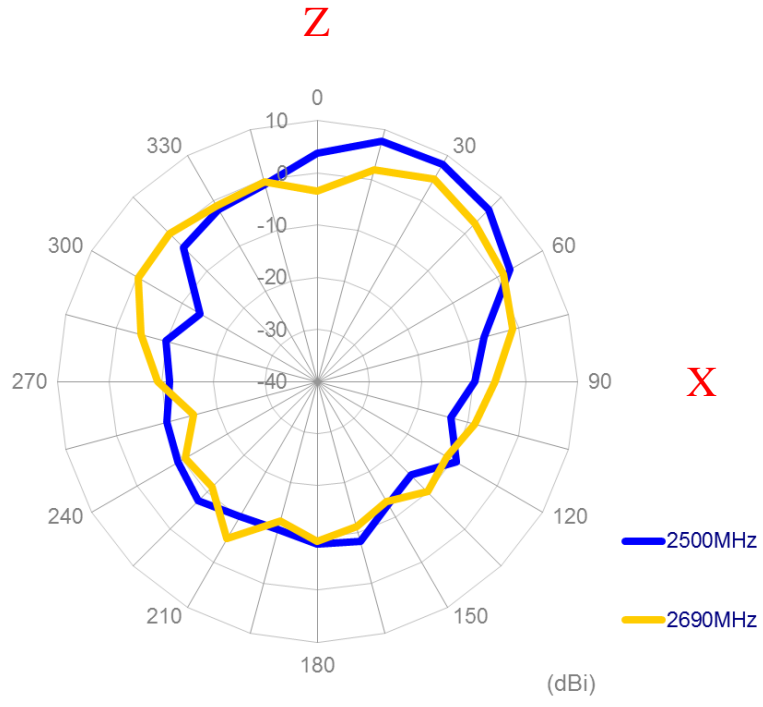

YZ Plane

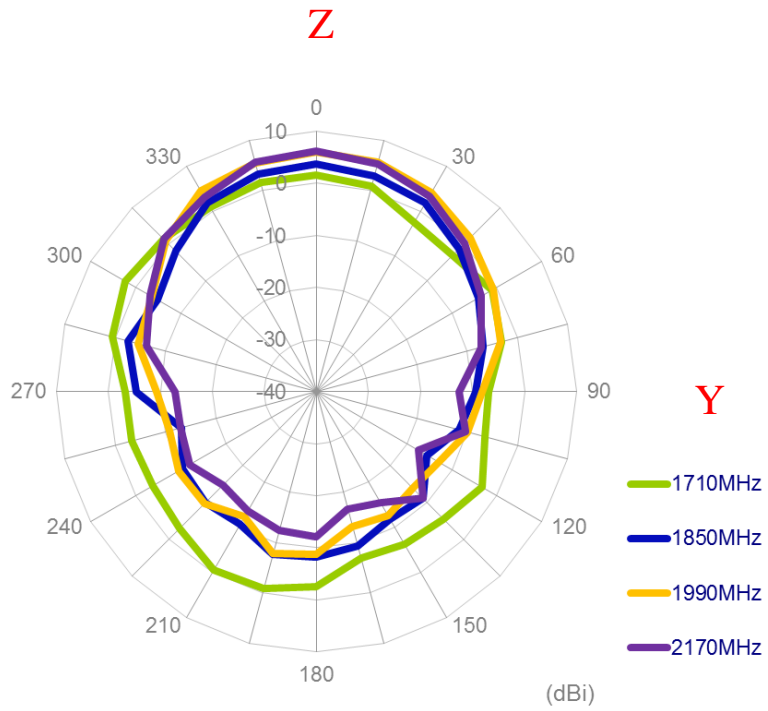
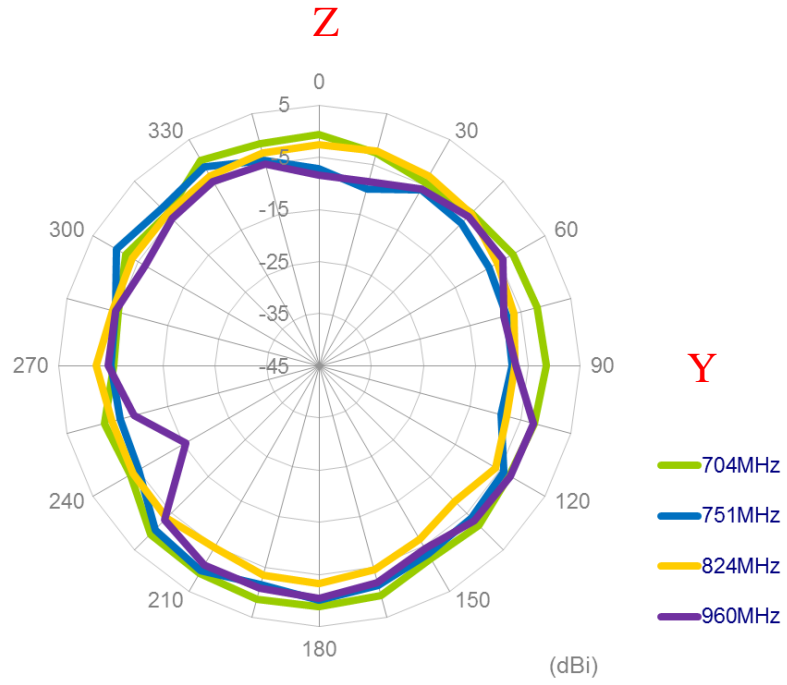

Z

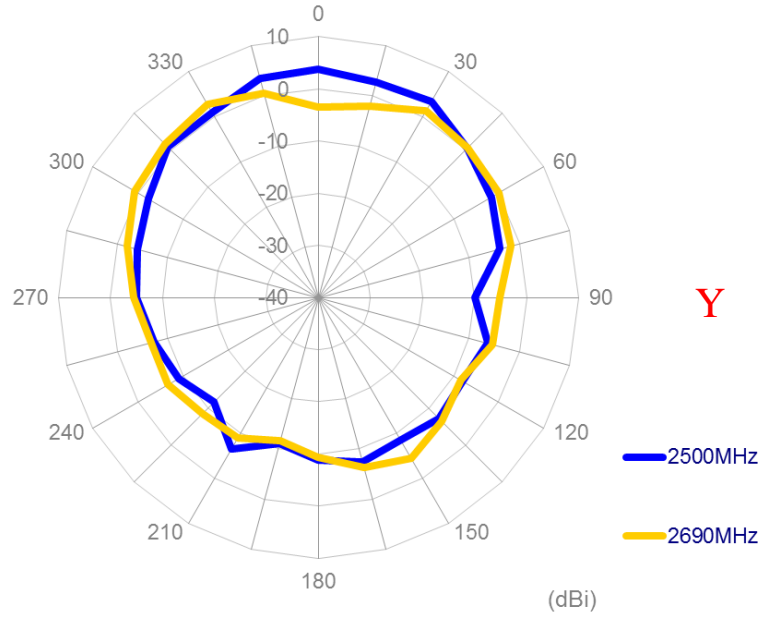

Z

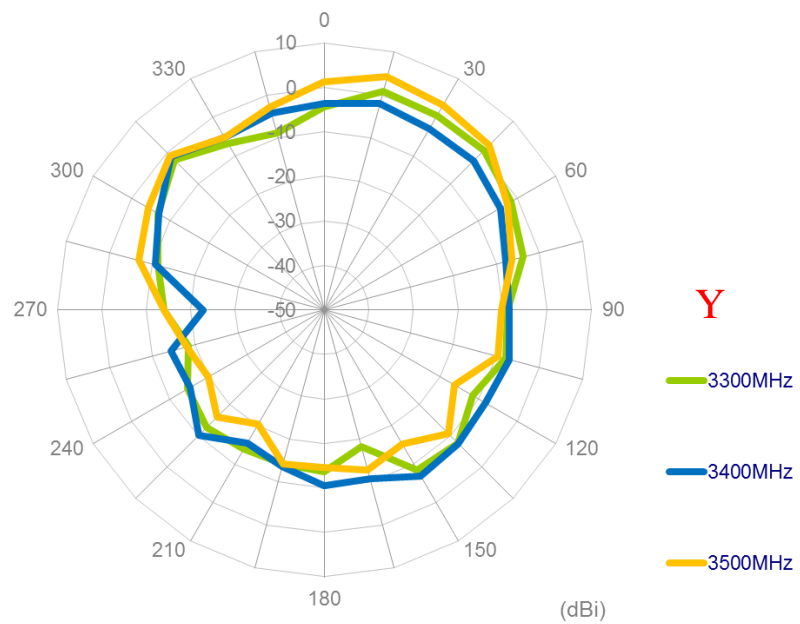

### 3.2.13 3D Radiation pattern (MIMO1 with 0.3M cable length in free space)

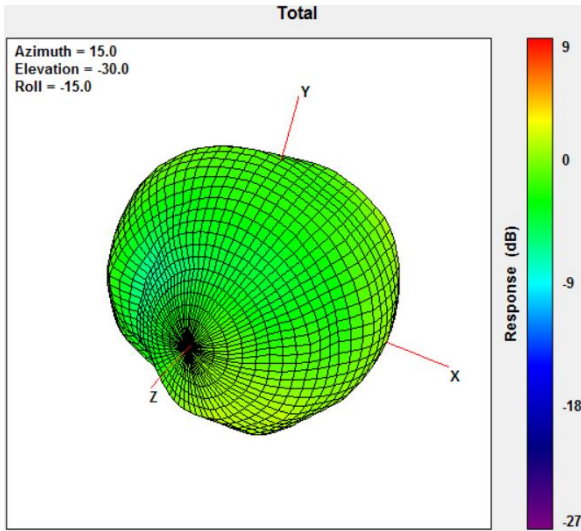

704MHz

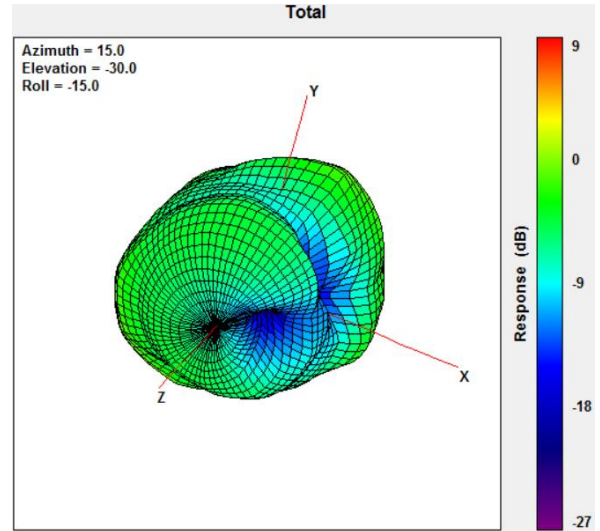

960MHz

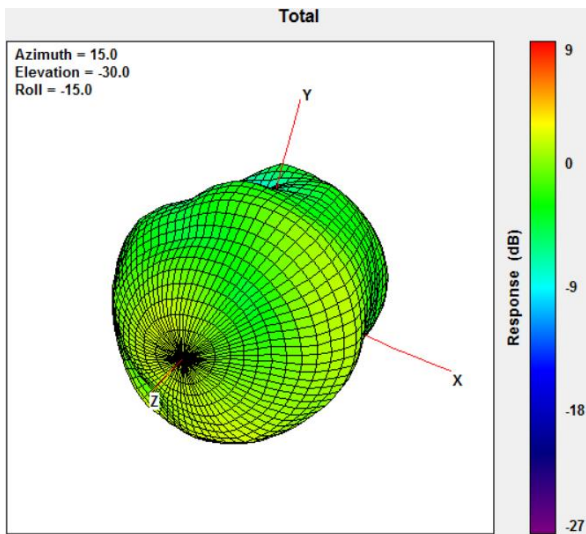

1710MHz

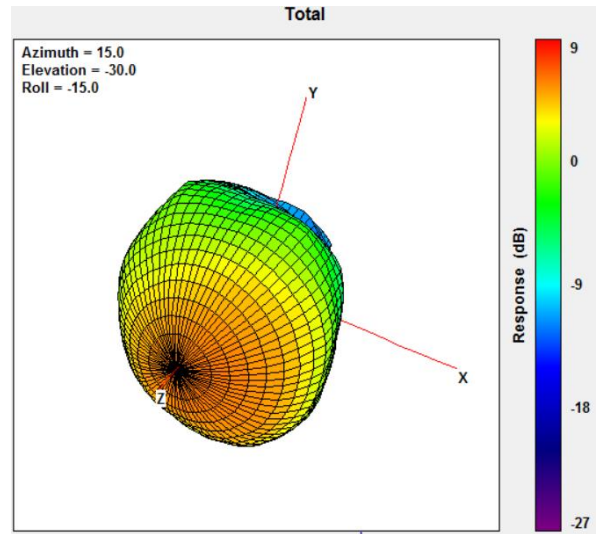

2170MHz



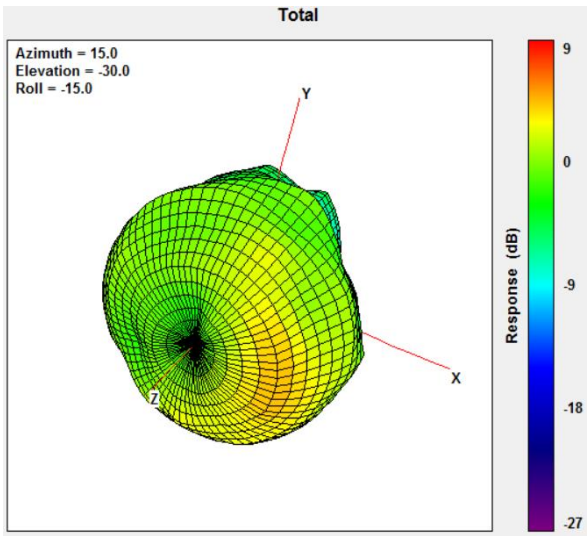

2690MHz

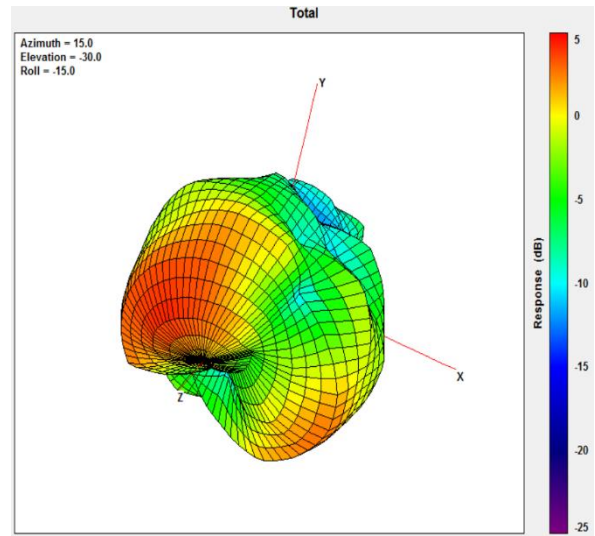

3500MHz

### 3.2.14 2D Radiation pattern (MIMO2 with 0.3M cable length in free space)

XY Plane

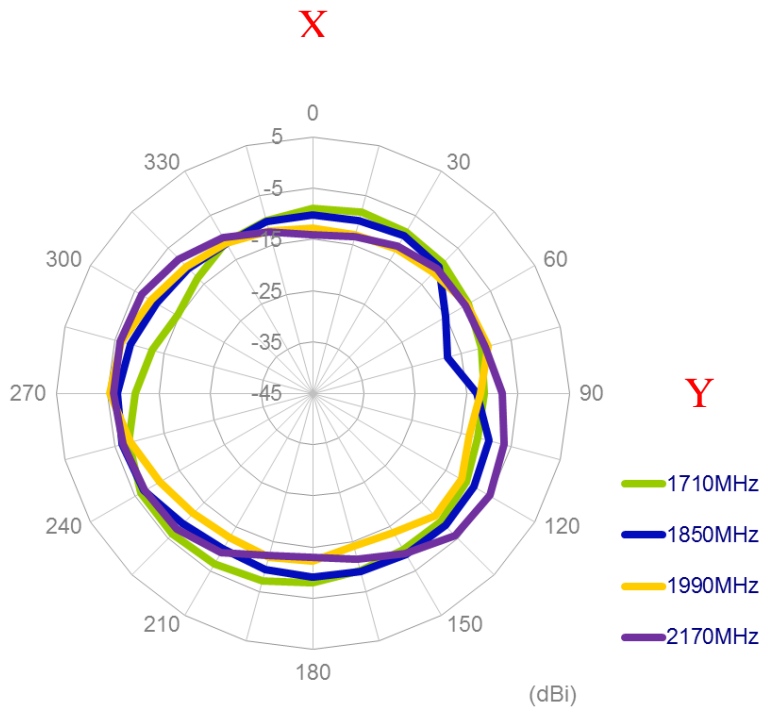
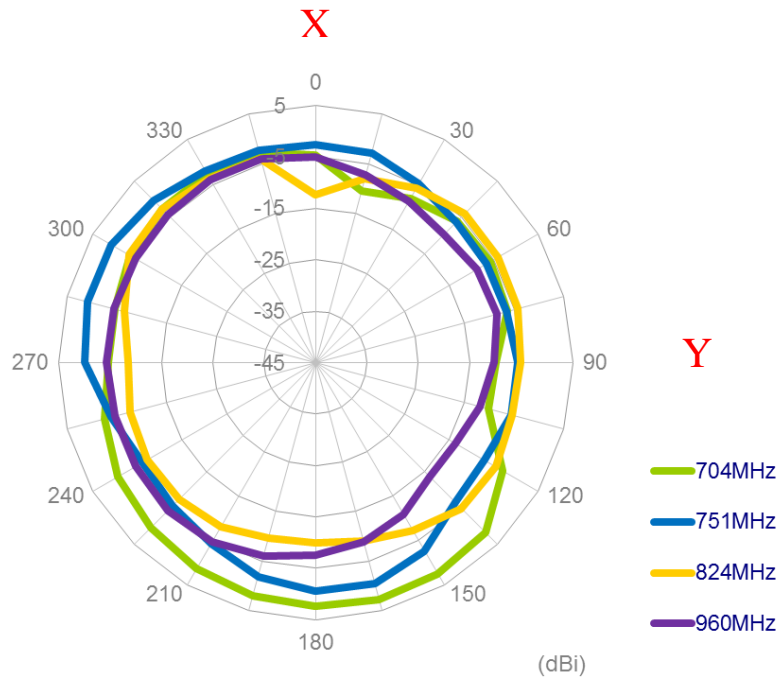

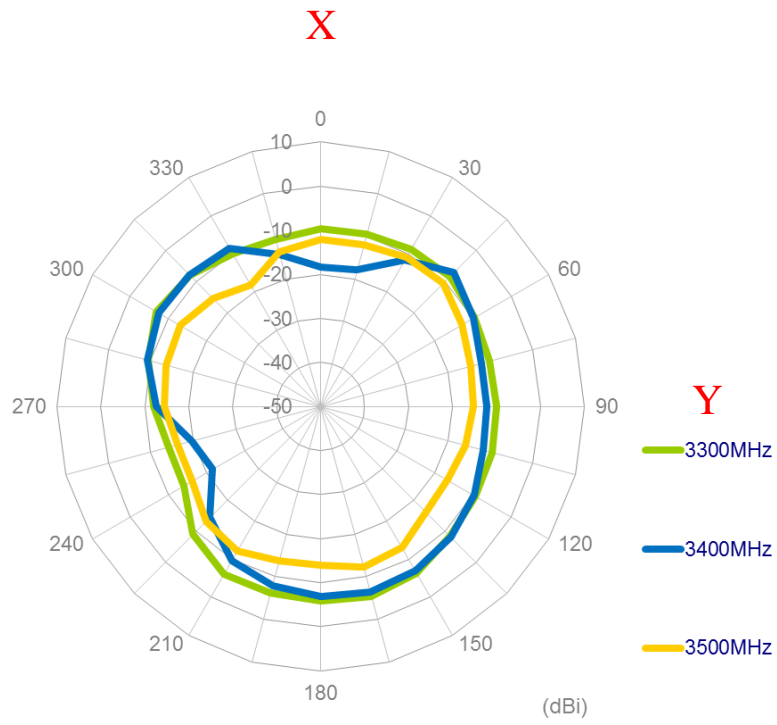
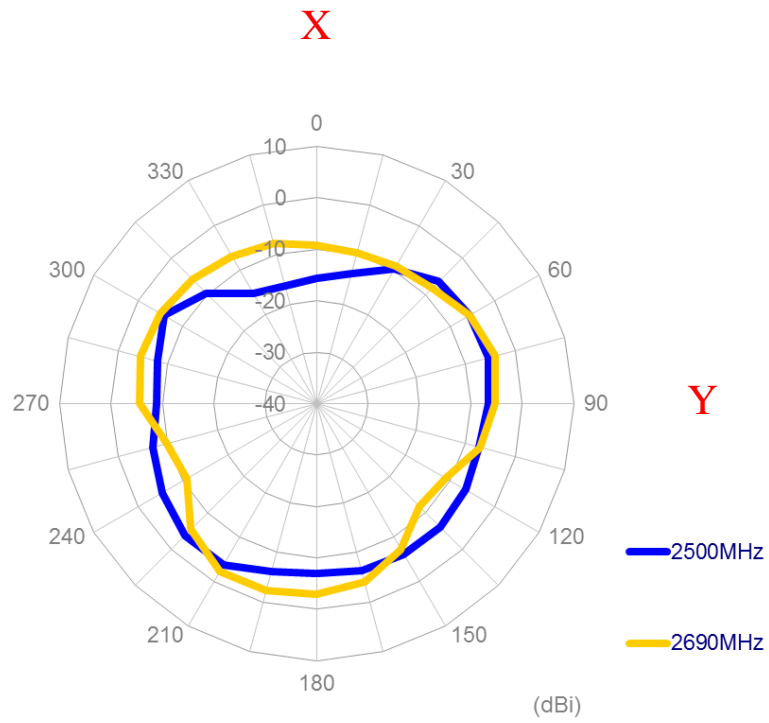

XZ Plane

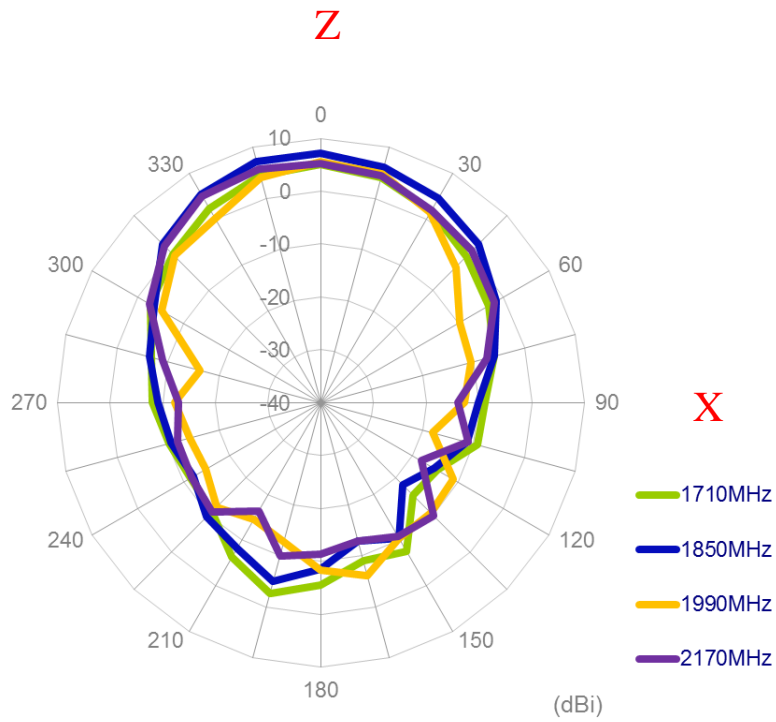
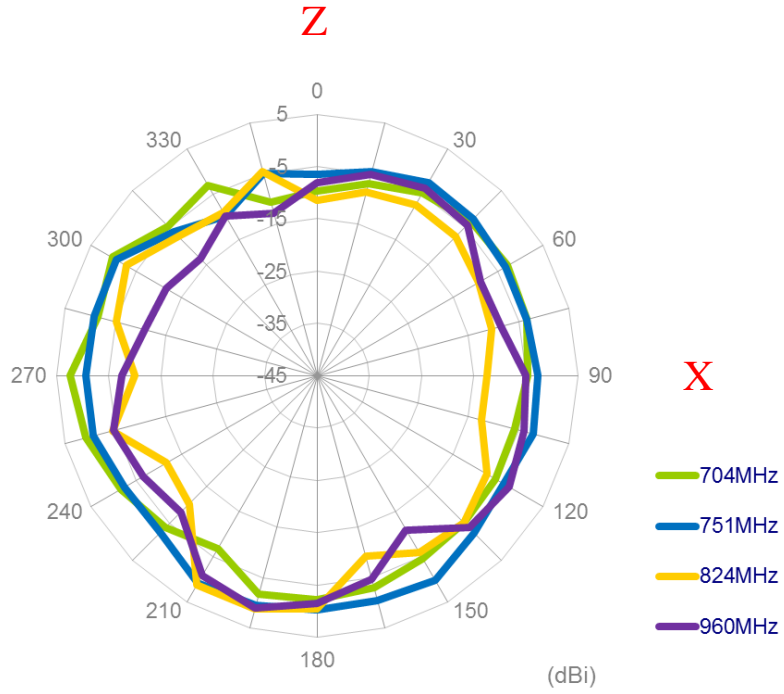

Z

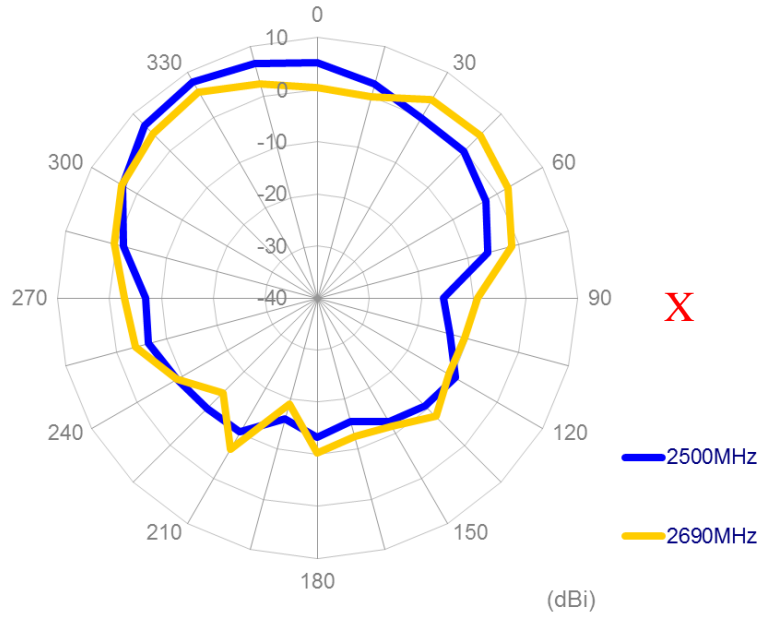

Z

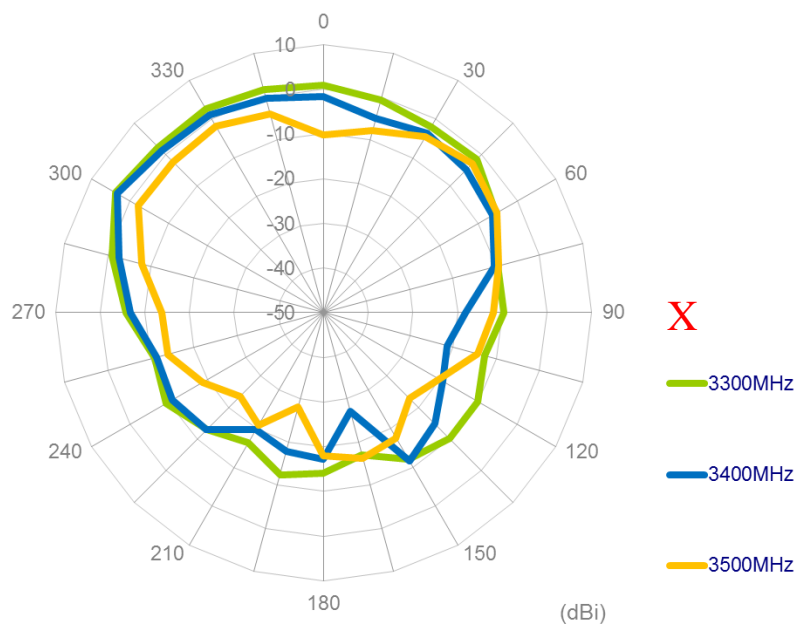

YZ Plane

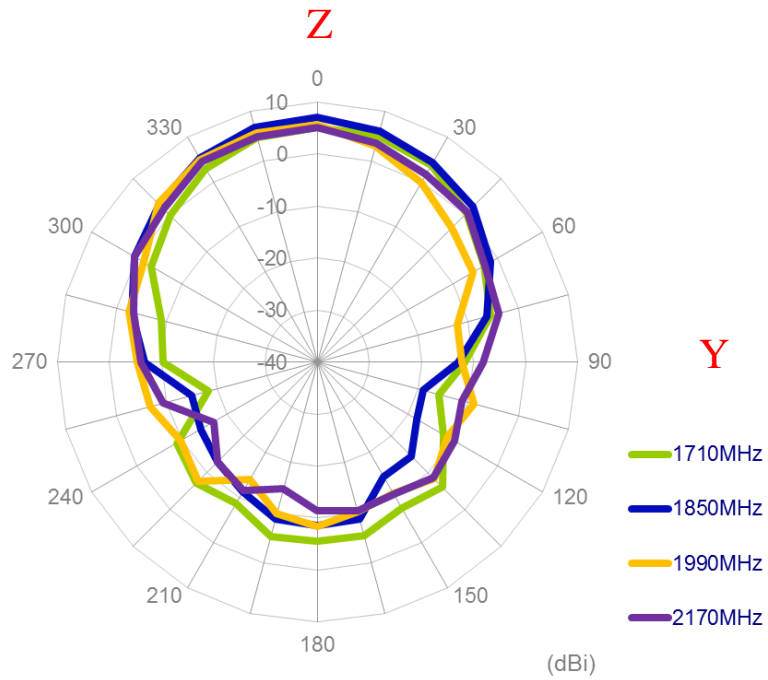
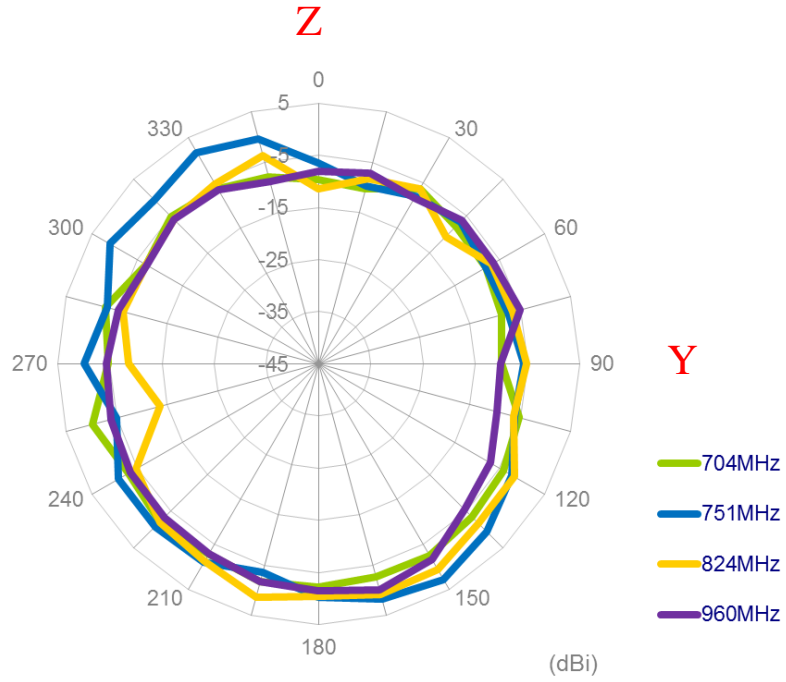

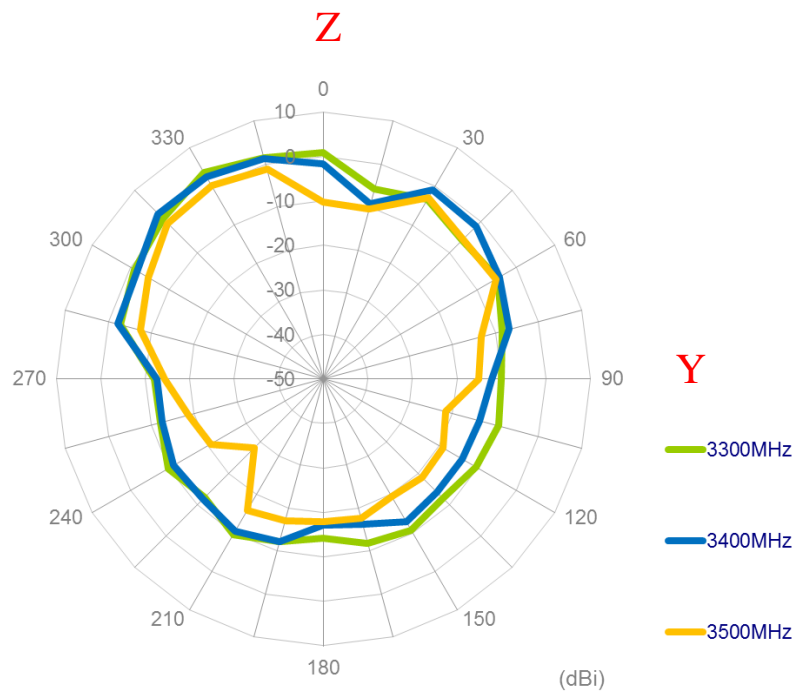
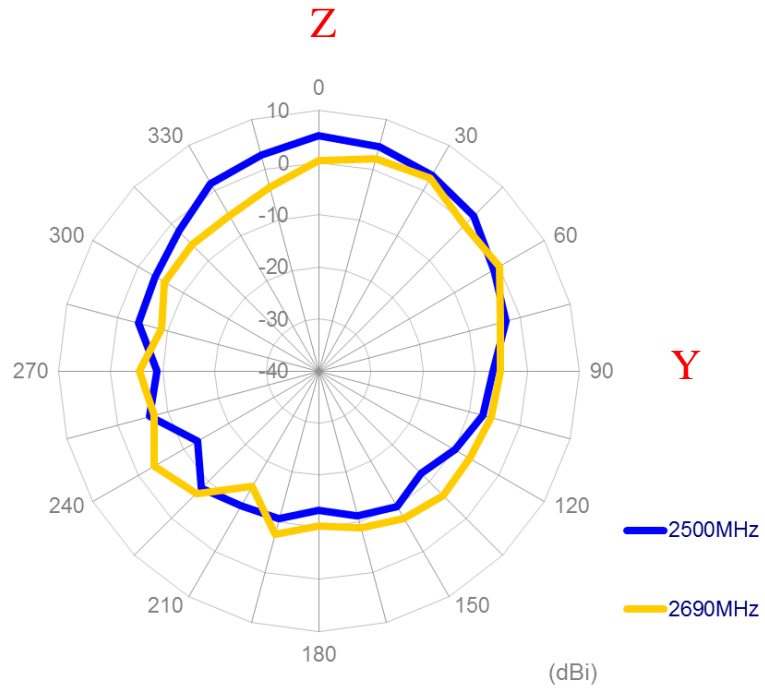

### 3.2.15 2D Radiation pattern (MIMO2 with 0.3M cable length in free space)

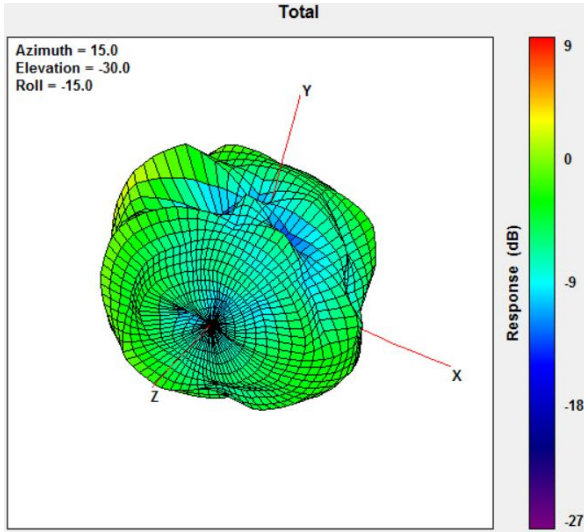

704MHz

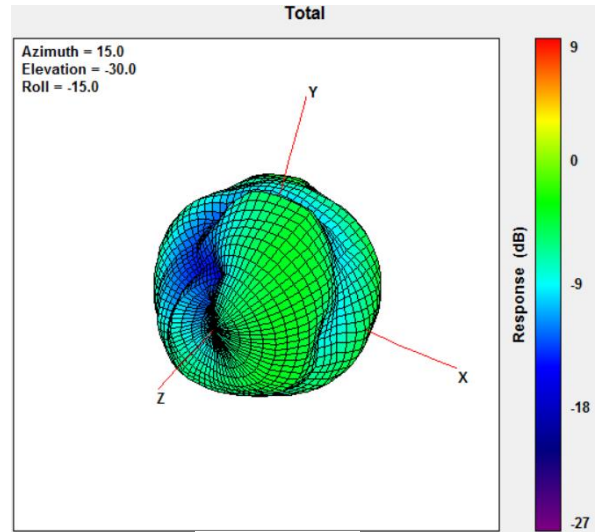

960MHz

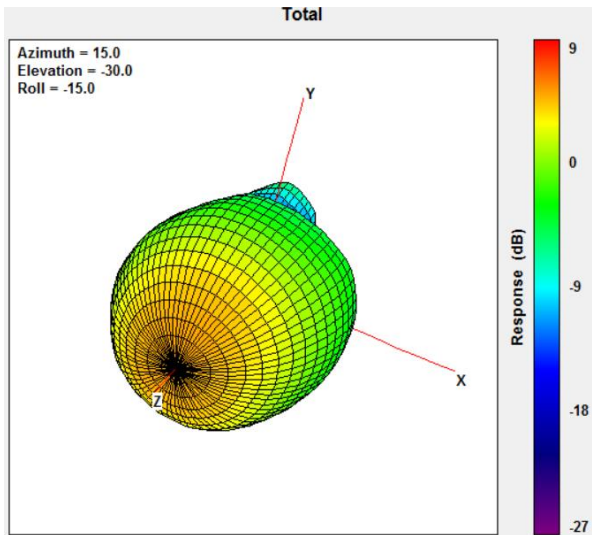

1710MHz

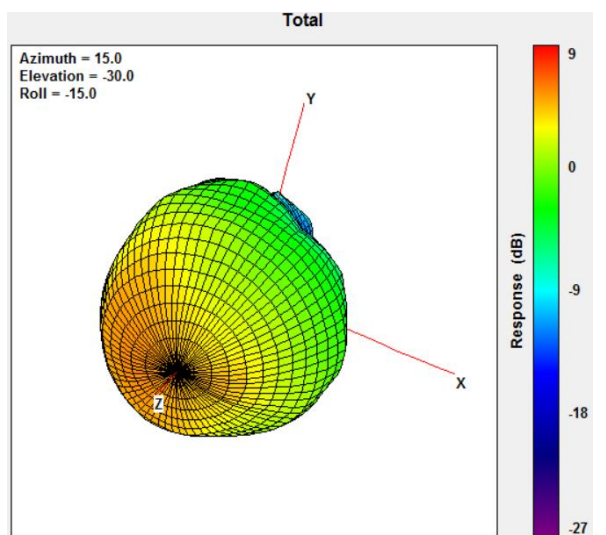

2170MHz



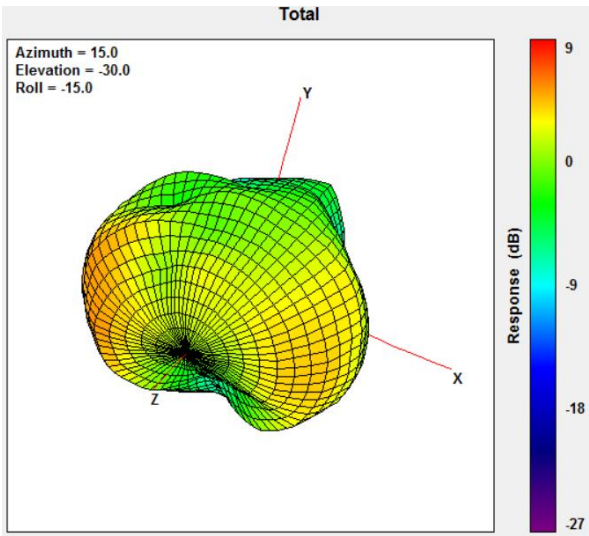

2690MHz

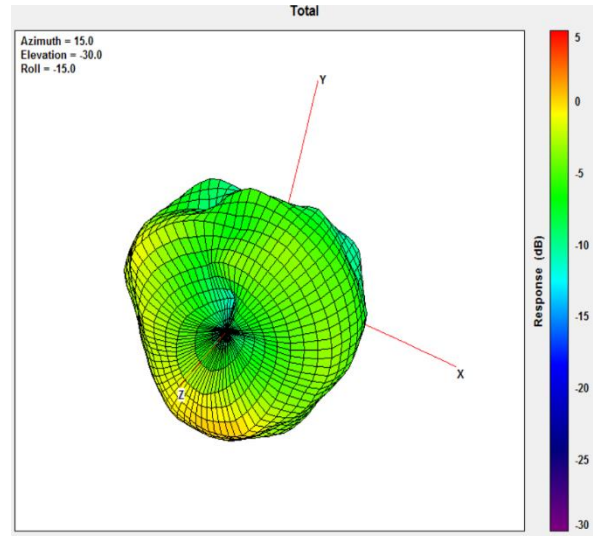

3500MHz

## 4. Mechanical Drawing (unit mm)

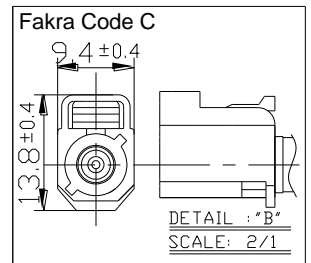
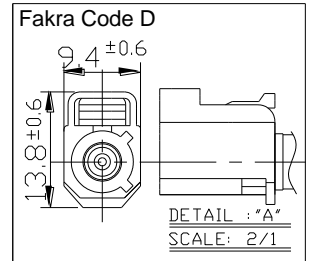
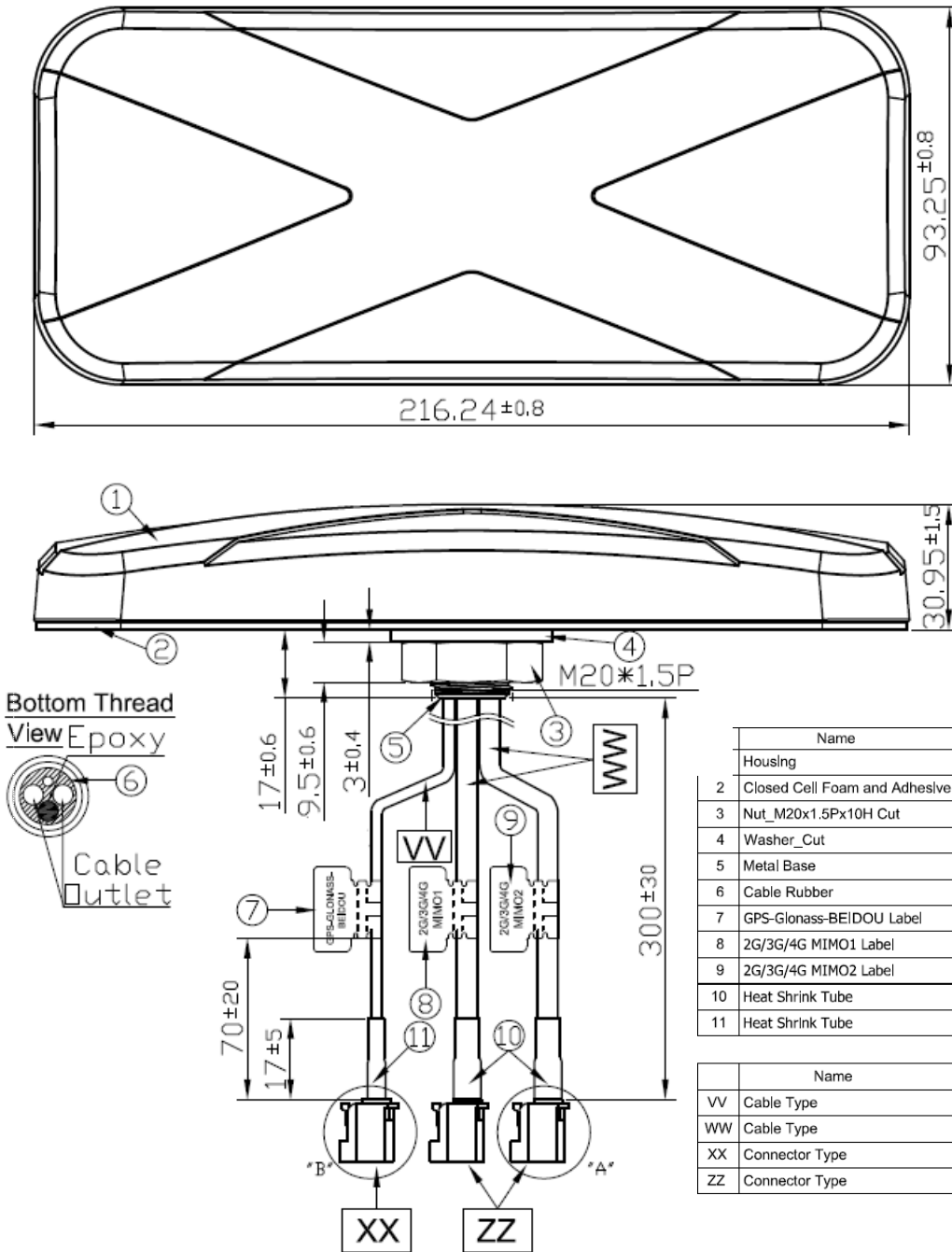

Name	P/N	Material	Finish	QTY
Housing	000113K000066A	ABS+PC	Black	1
2 Closed Cell Foam and Adheslve Tape	001013K000039A	3M 9448+CR-4305	Black	1
3 Nut_M20x1.5Px10H Cut	000413E030061A	Steel	Ni Plated	1
4 Washer_Cut	000413E040061A	Steel	Ni Plated	1
5 Metal Base	000313K000060A	AL	Ni Plated	1
6 Cable Rubber	000713E000063A	Silicone Rubber	Black	1
7 GPS-Glonass-BEIDOU Label	001014E030051A	Coated Paper	Orange	1
8 2G/3G/4G MIMO1 Label	001012L080051A	Coated Paper	Gray	1
9 2G/3G/4G MIMO2 Label	001012L090051A	Coated Paper	White	1
10 Heat Shrink Tube	001311F010013A	PE	Black	2
11 Heat Shrink Tube	001311F000013A	PE	Black	1

Name	P/N	Spec	Finish	QTY
VV Cable Type	301313A000013A	RG174	Black	1
WW Cable Type	301412K010013A	CFD200	Black	2
XX Connector Type	202311G010003A	Fakra Code C	Blue	1
ZZ Connector Type	202413K010003A	Fakra Code D	Violet	2

## 5. Installation

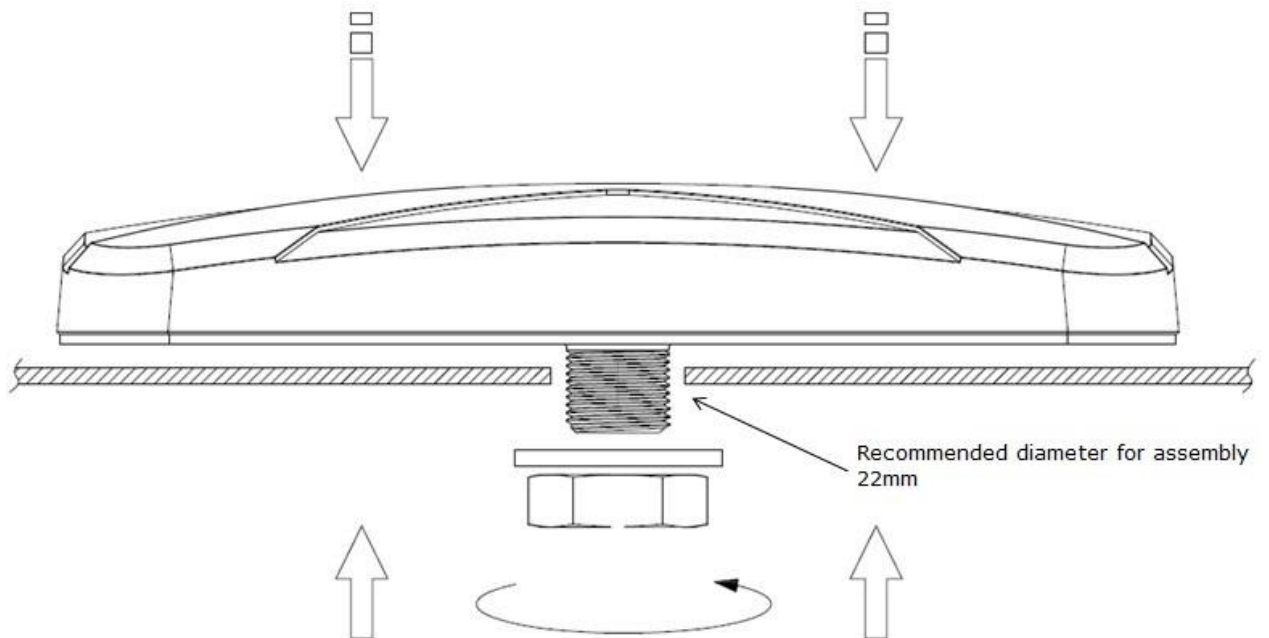

Recommended torque for mounting is 29.4 N.m  
Maximum torque for mounting is 39.2 N.m

## 6.Packaging

### MA411.A.LBI.001

#### Packaging Specifications

1pc MA411.A.LBI.001 per small box  
 Box Dimensions - 325x125x106mm  
 Weight - 645g

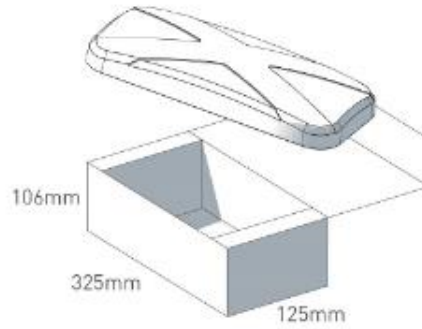

9 small boxes in one carton  
 Carton Dimensions - 360x360x400mm  
 Weight - 6.57Kg

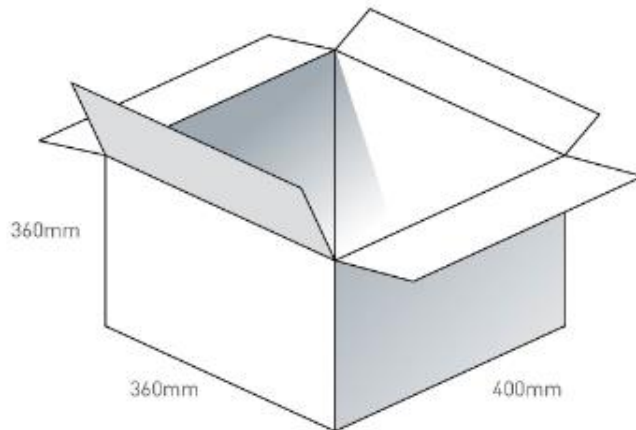



Pallet Dimensions 1080x720x1350mm  
15 Cartons per Pallet  
5 Cartons per layer  
3 Layers

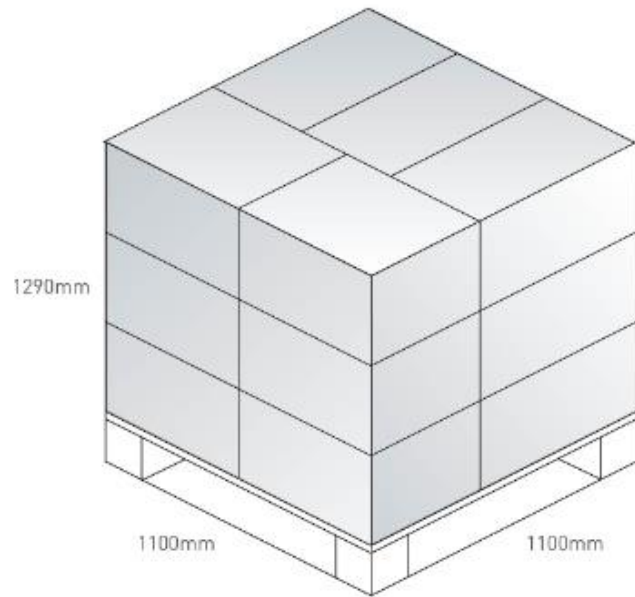

## 7. Application Note (LTE MIMO Antenna)

The MA411 antenna performance with different cable lengths and different environments is shown below.

### 7.1 On the 50\*50cm ground plane

#### 7.1.1 Return Loss (MIMO\_1 on the 50\*50cm ground plane)

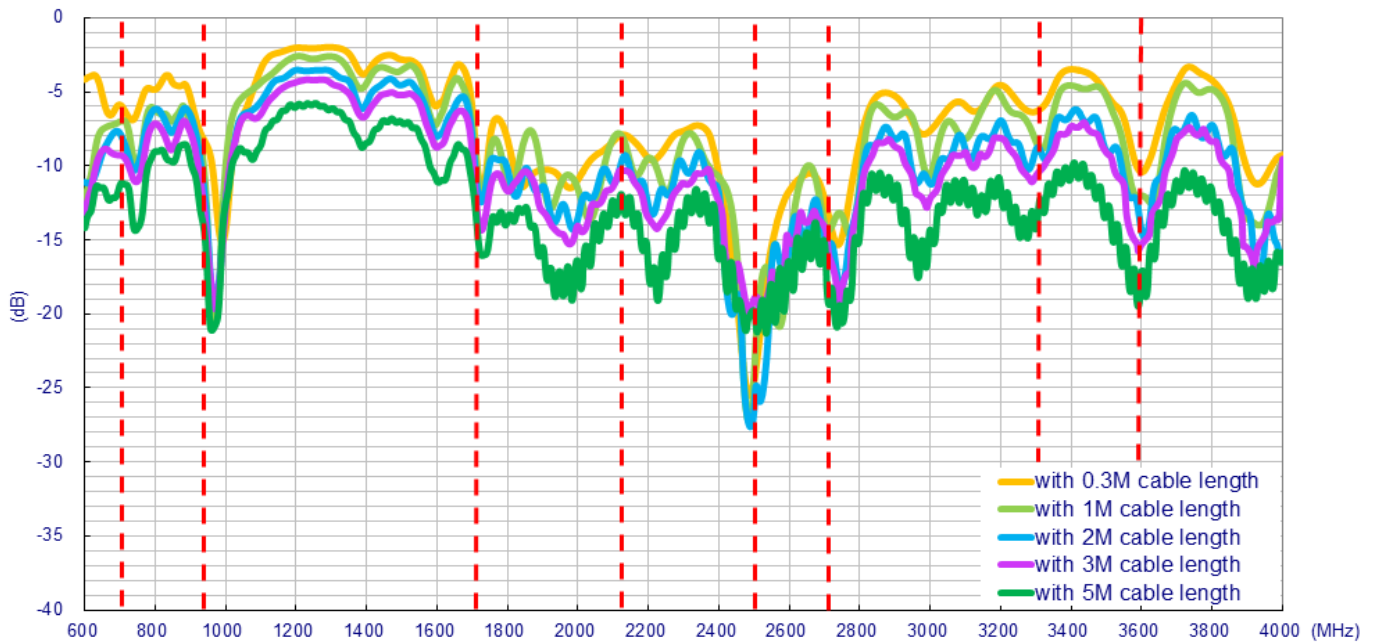

#### 7.1.2 Return Loss (MIMO\_2 on the 50\*50cm ground plane)

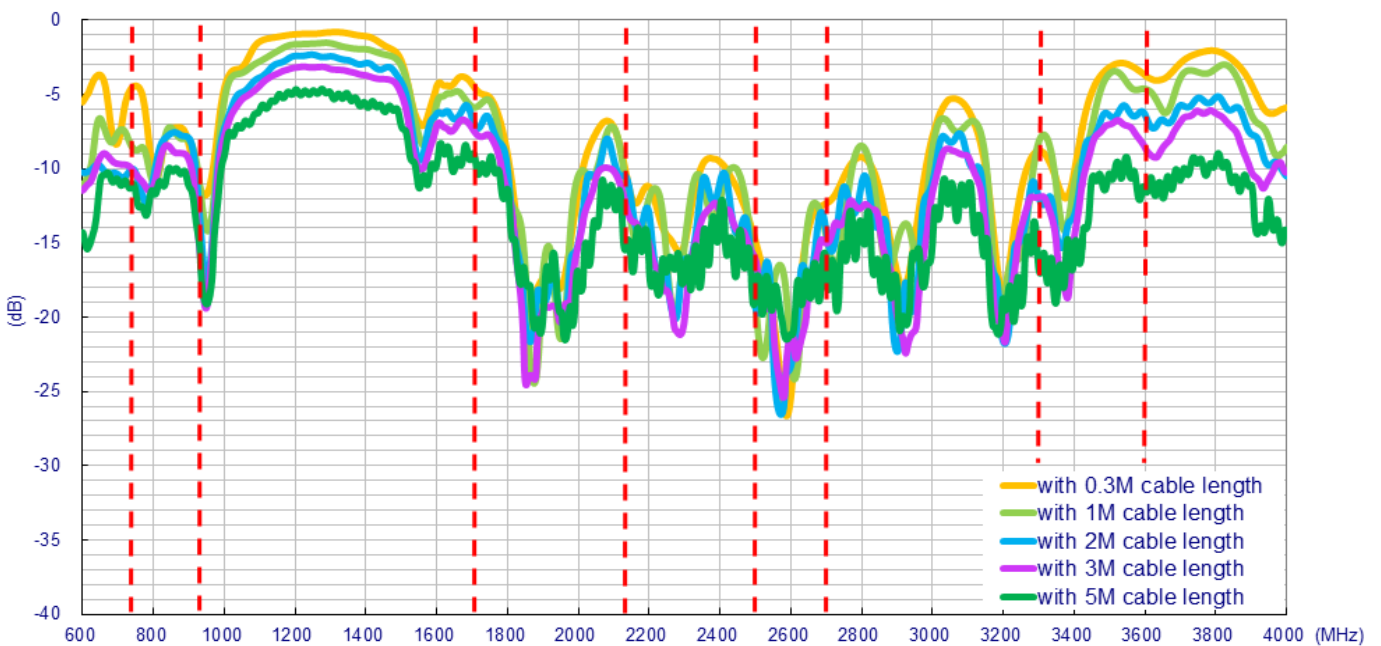

### 7.1.3 Insertion Loss (on the 50\*50cm ground plane)

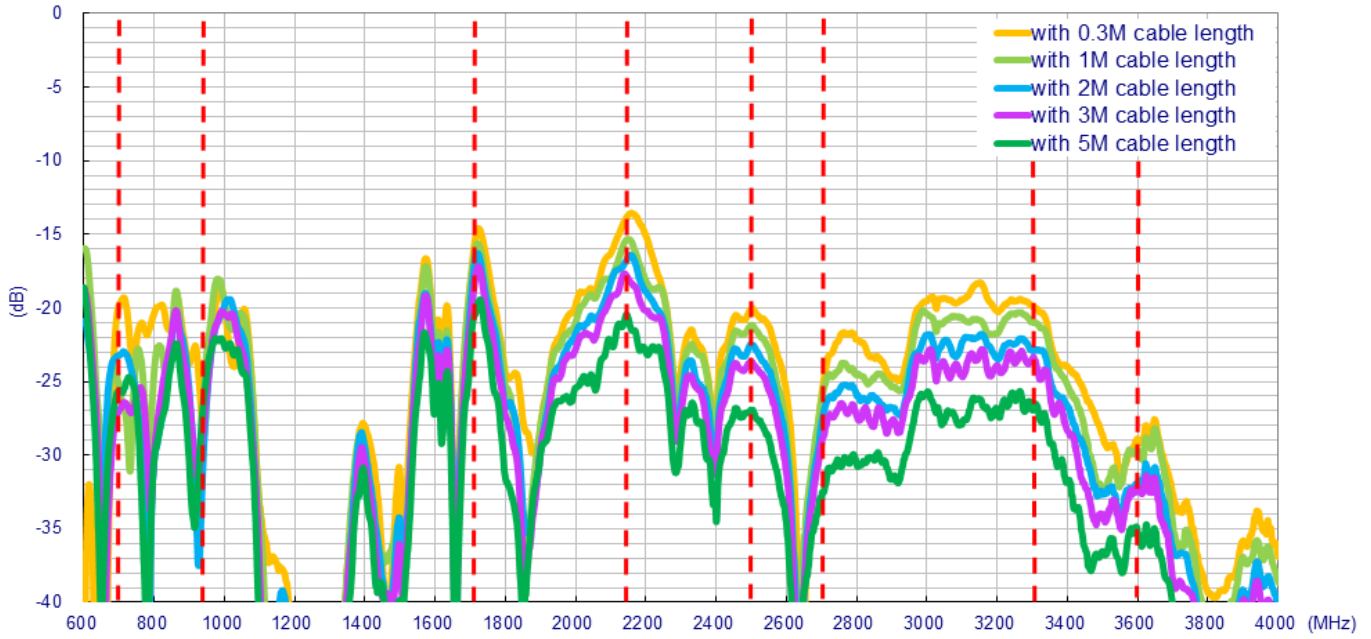

### 7.1.4 Efficiency (MIMO\_1 on the 50\*50cm ground plane)

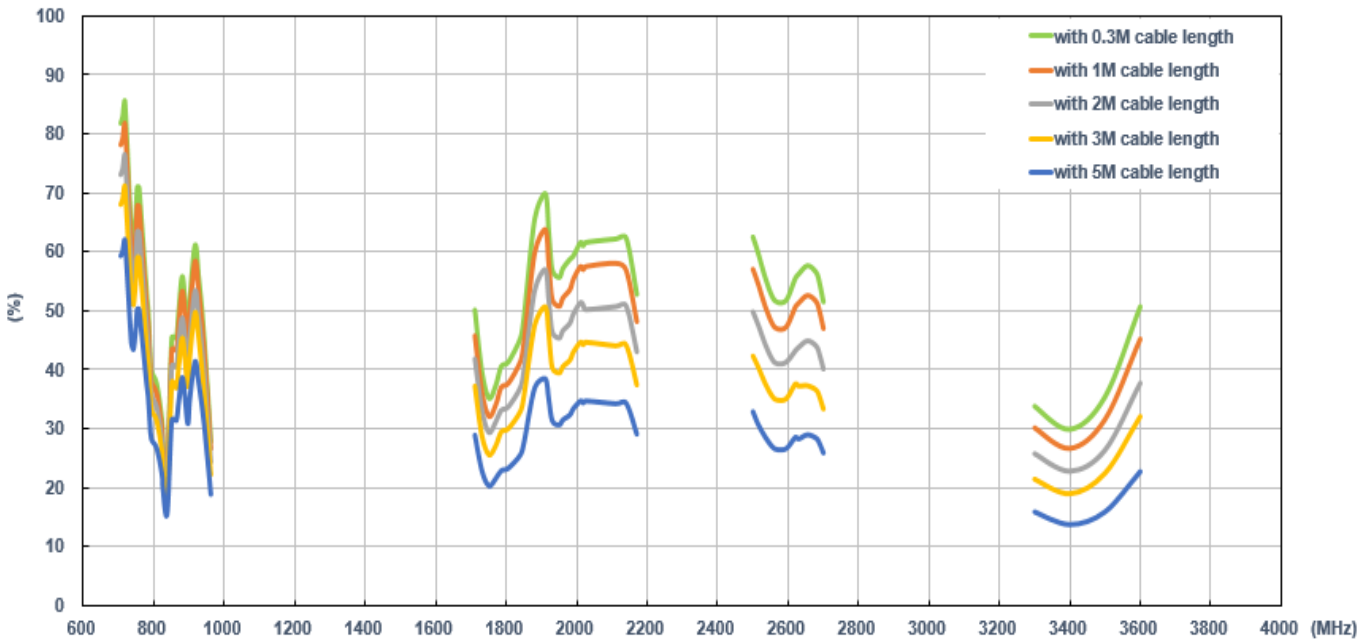

### 7.1.5 Efficiency (MIMO\_2 on the 50\*50cm ground plane)

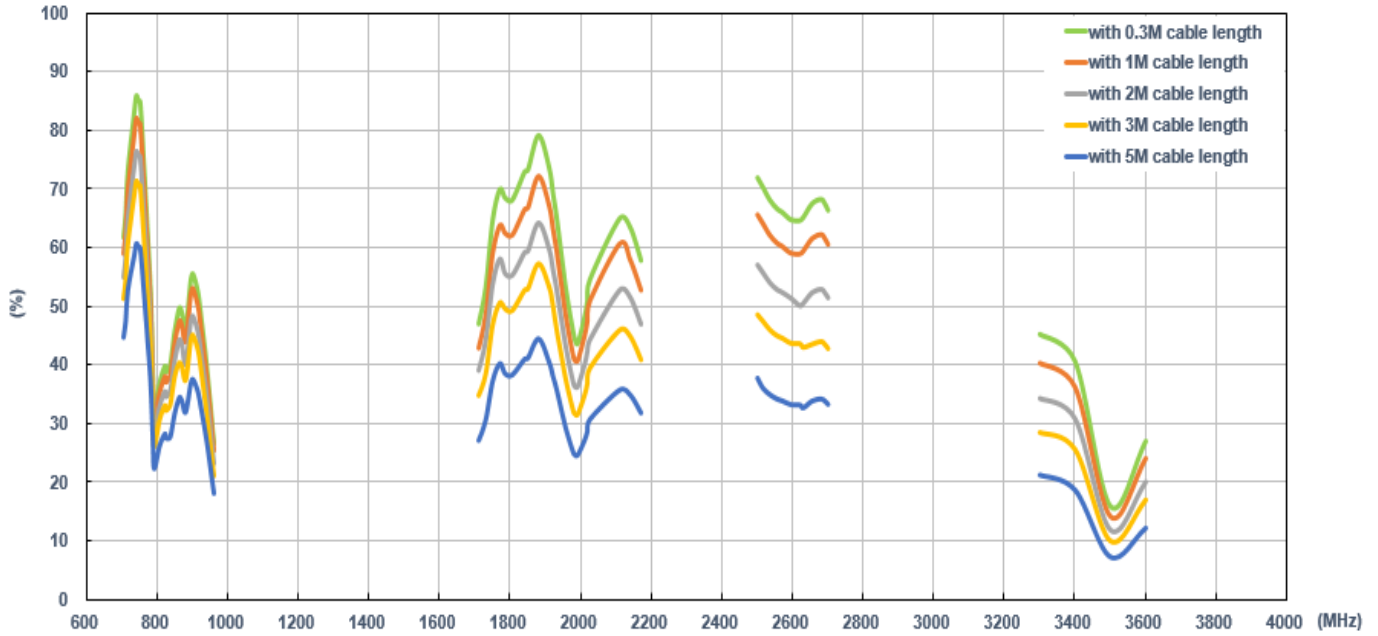

### 7.1.6 Average Gain (MIMO\_1 on the 50\*50cm ground plane)

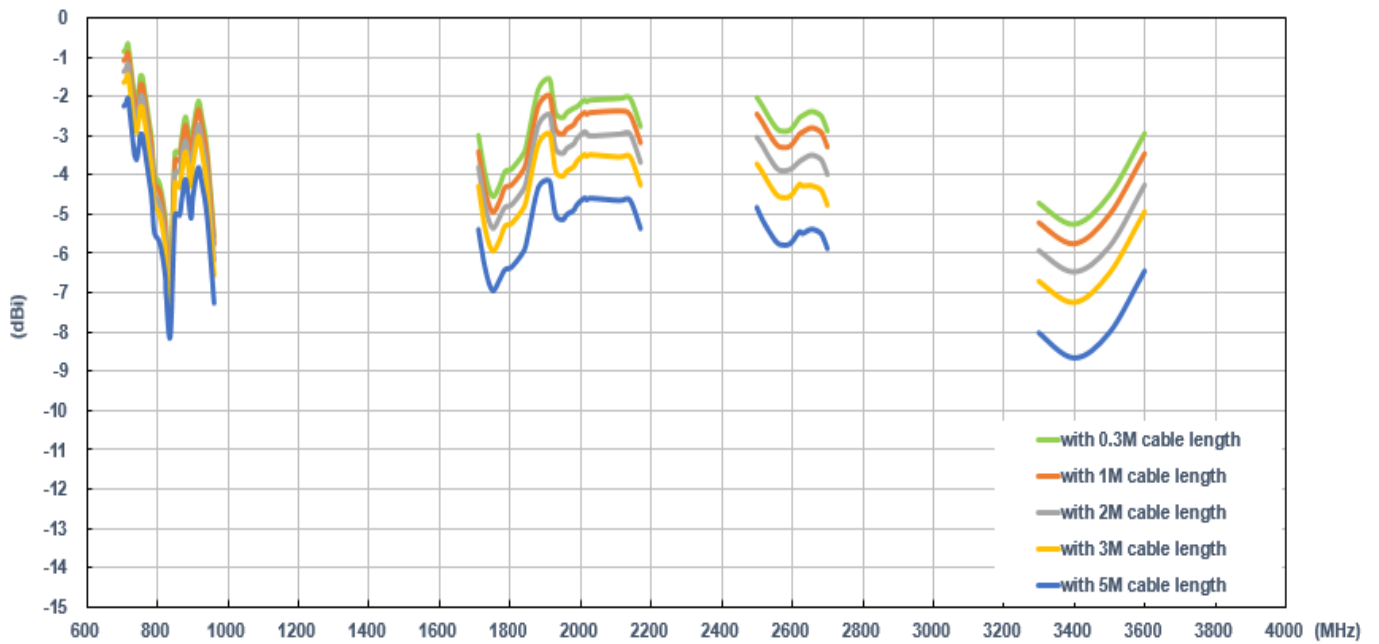



### 7.1.7 Average Gain (MIMO\_2 on the 50\*50cm ground plane)

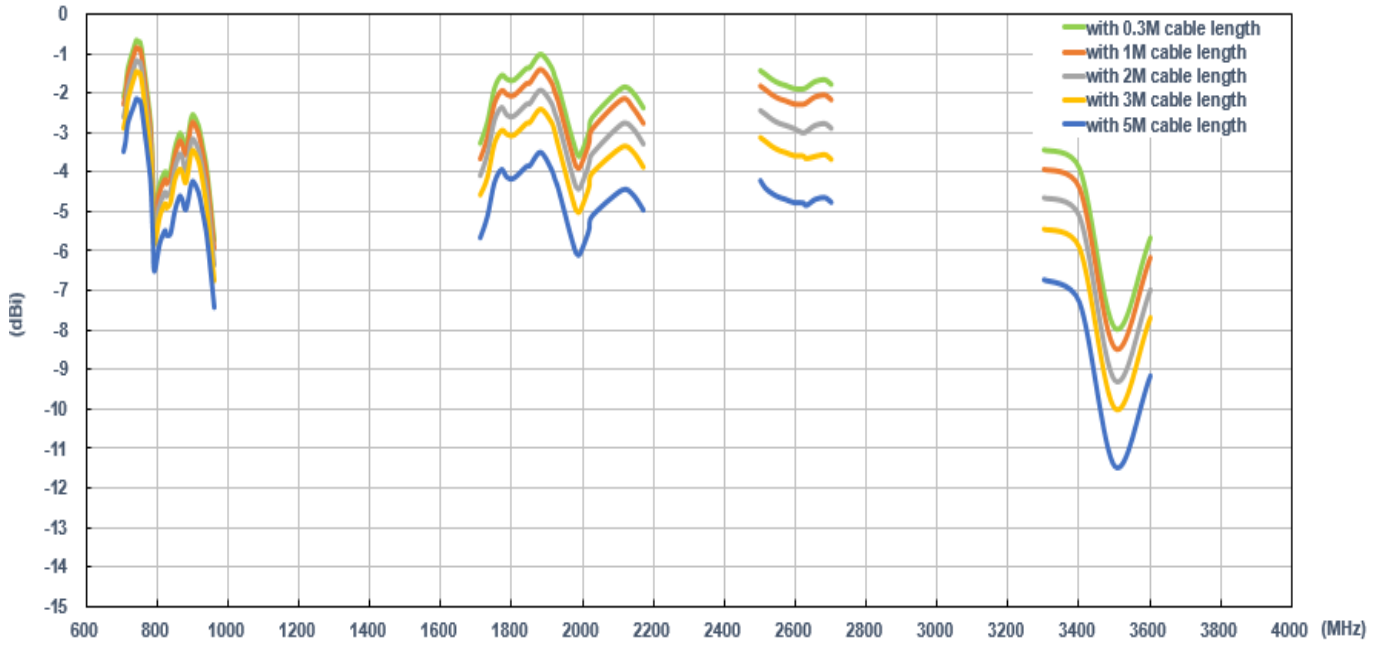

### 7.1.8 Peak Gain (MIMO\_1 on the 50\*50cm ground plane)

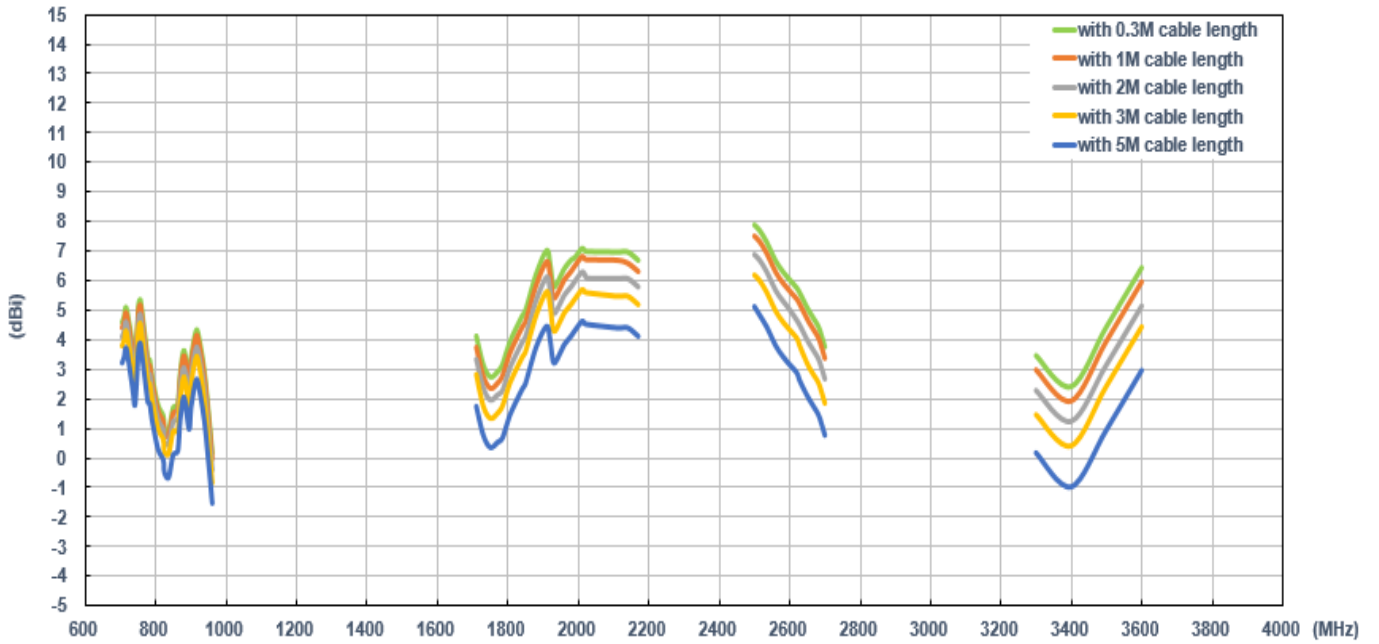

### 7.1.9 Peak Gain (MIMO\_2 on the 50\*50cm ground plane)

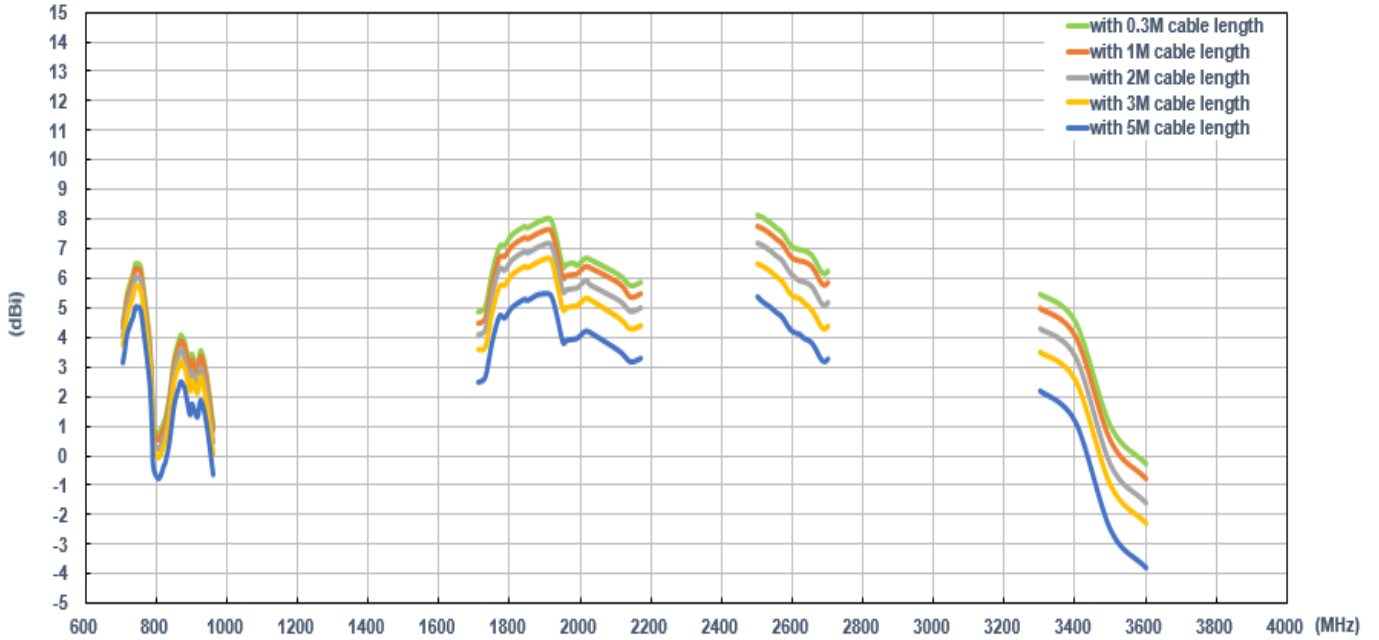

## 7.2 In free space

### 7.2.1 Return Loss (MIMO\_1 in free space)

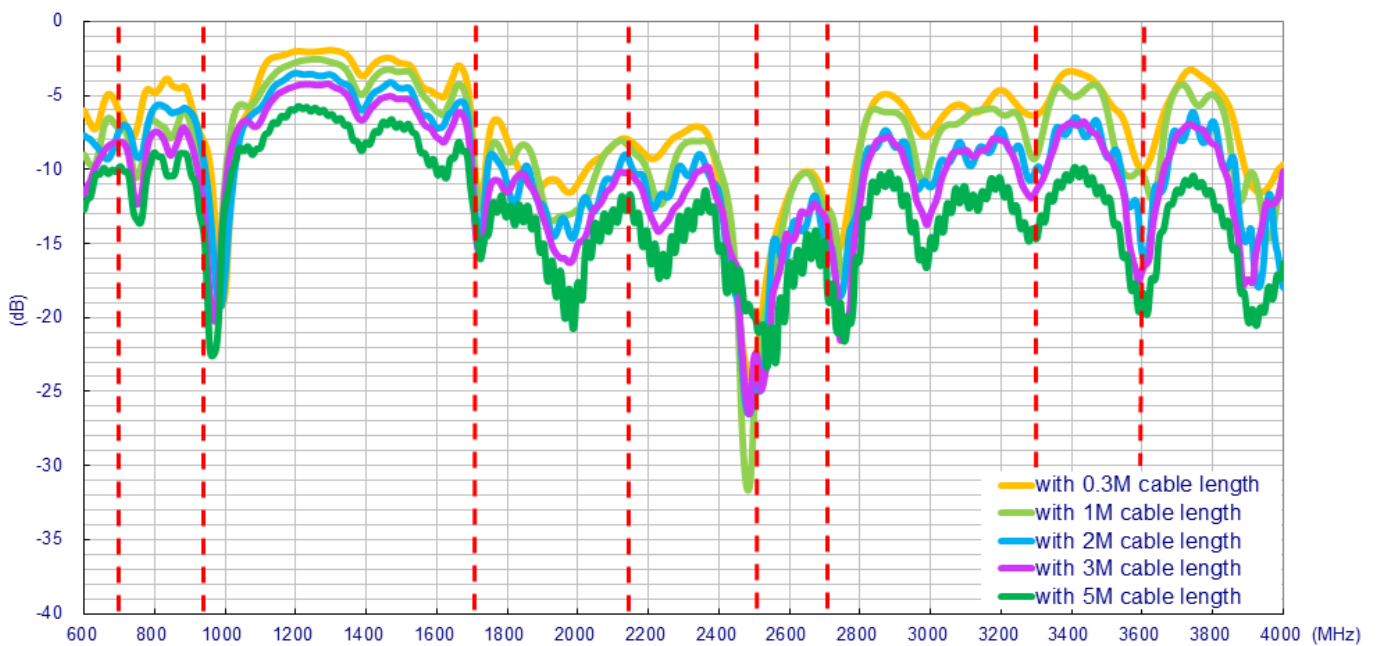

### 7.2.2 Return Loss (MIMO\_2 in free space)

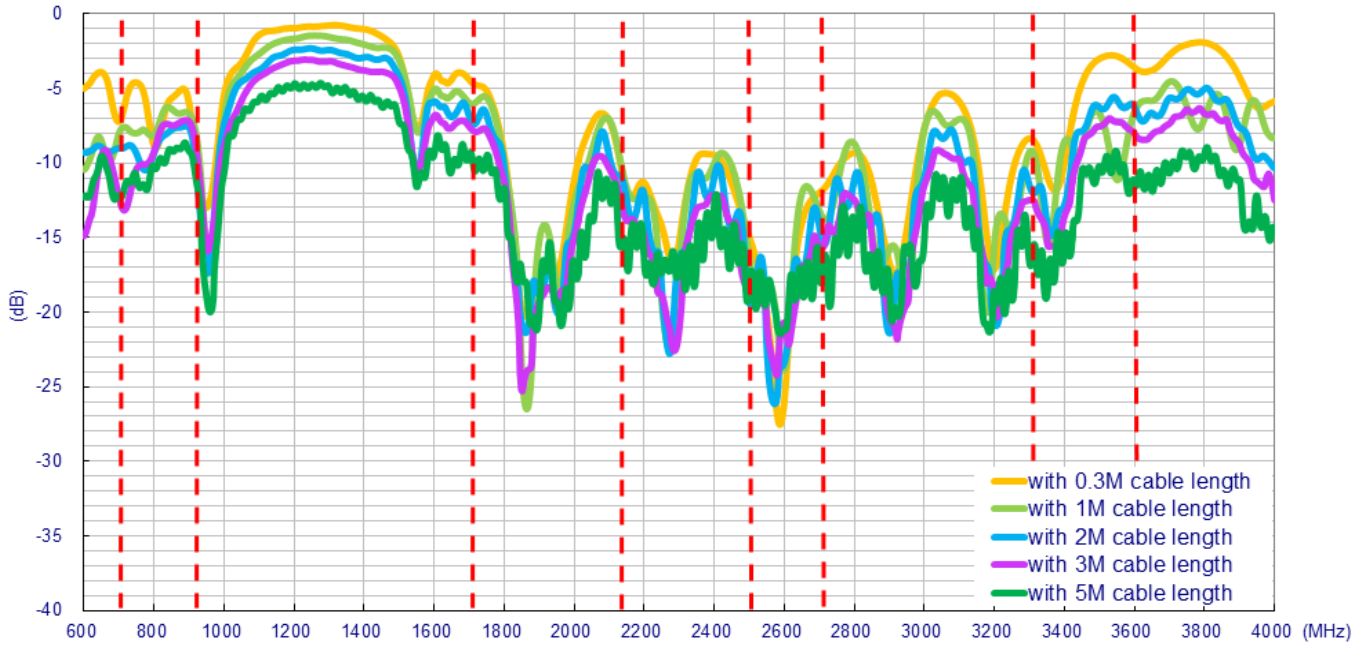

### 7.2.3 Insertion Loss (in free space)

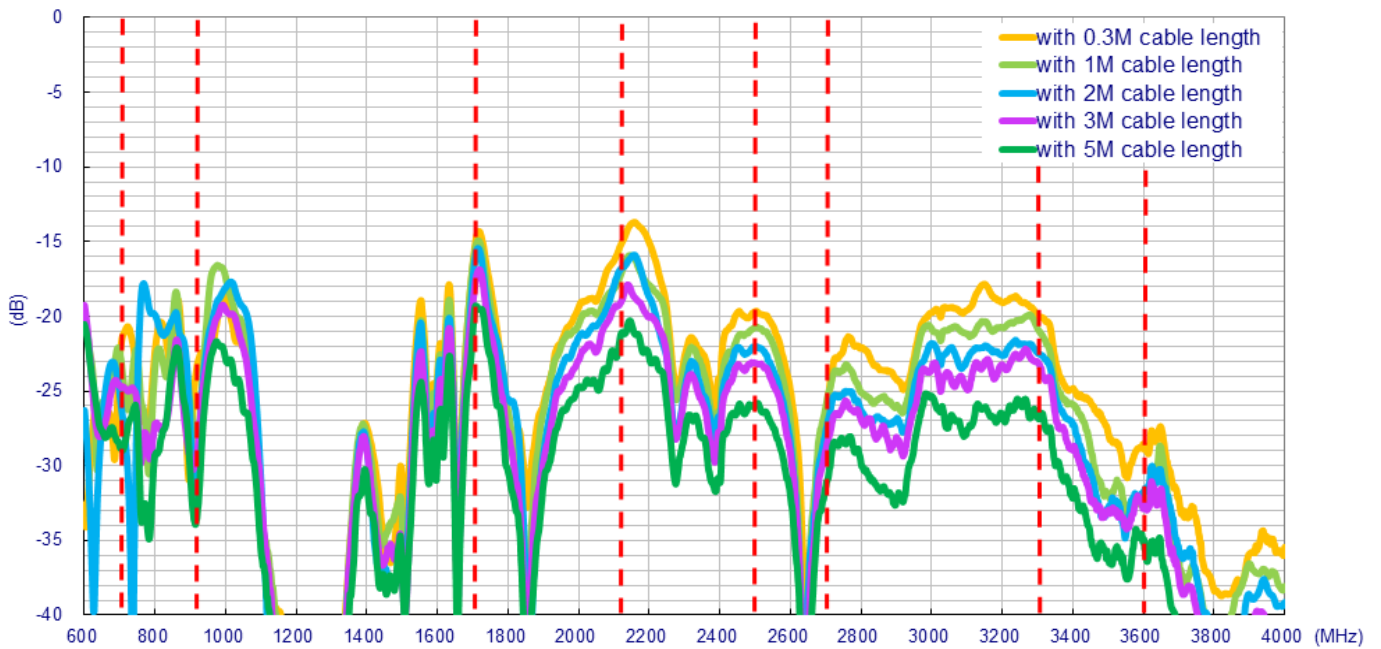

### 7.2.4 Efficiency (MIMO\_1 in free space)

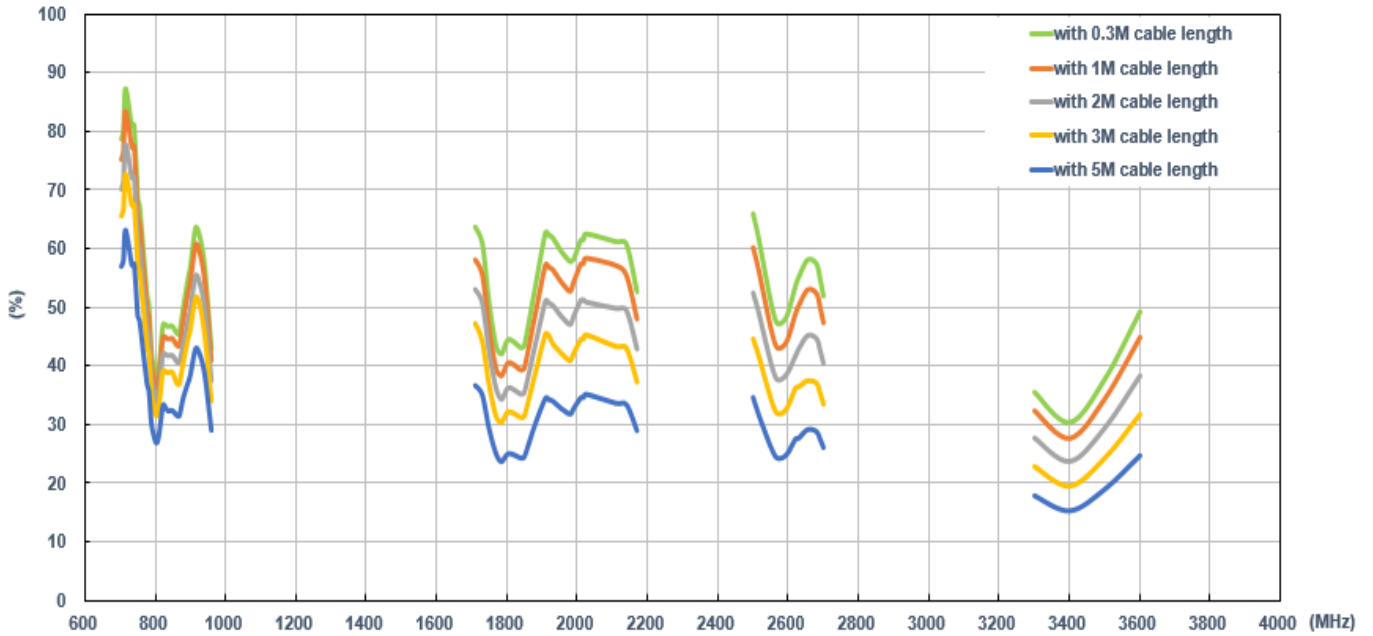

### 7.2.5 Efficiency (MIMO\_2 in free space)

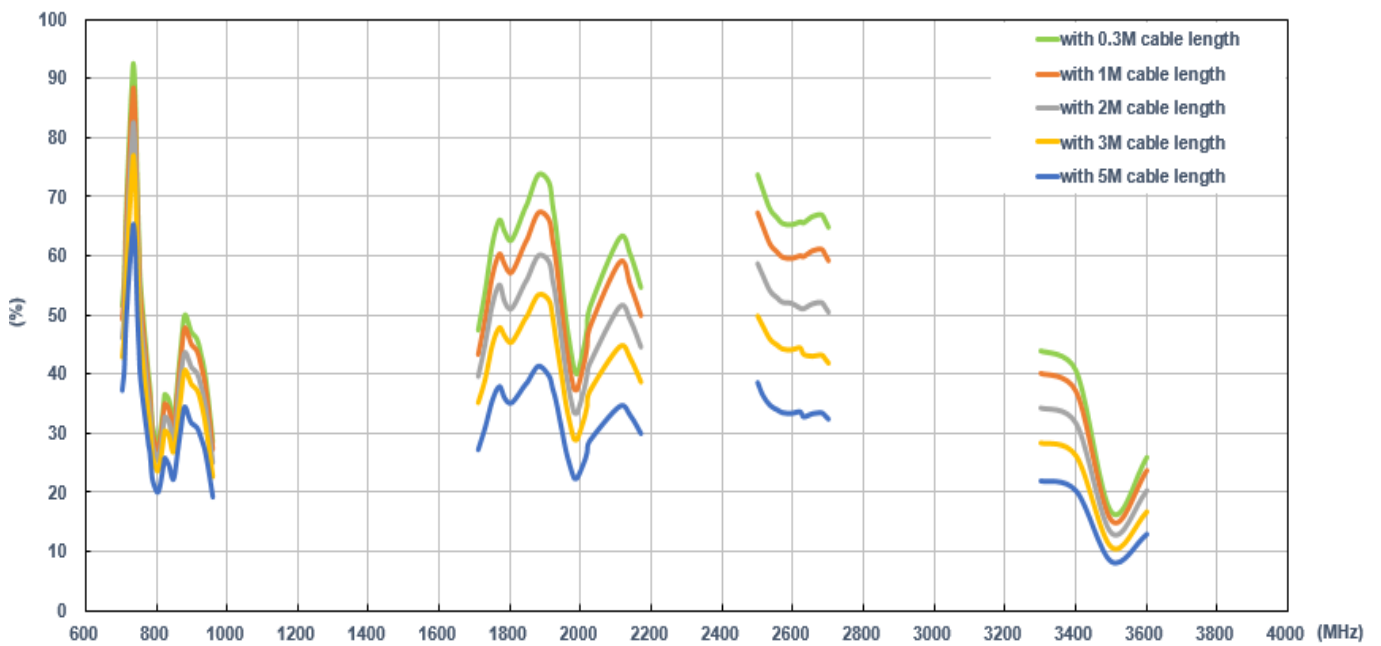

### 7.2.6 Average Gain (MIMO\_1 in free space)

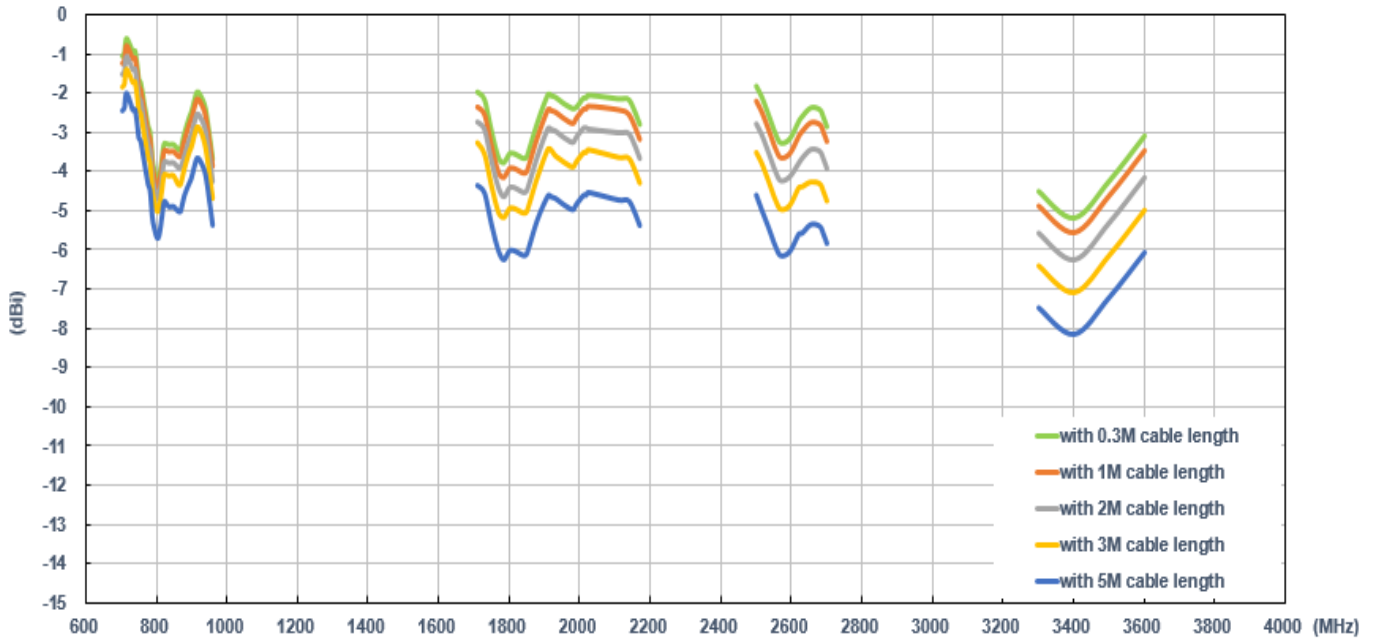

### 7.2.7 Average Gain (MIMO\_2 in free space)

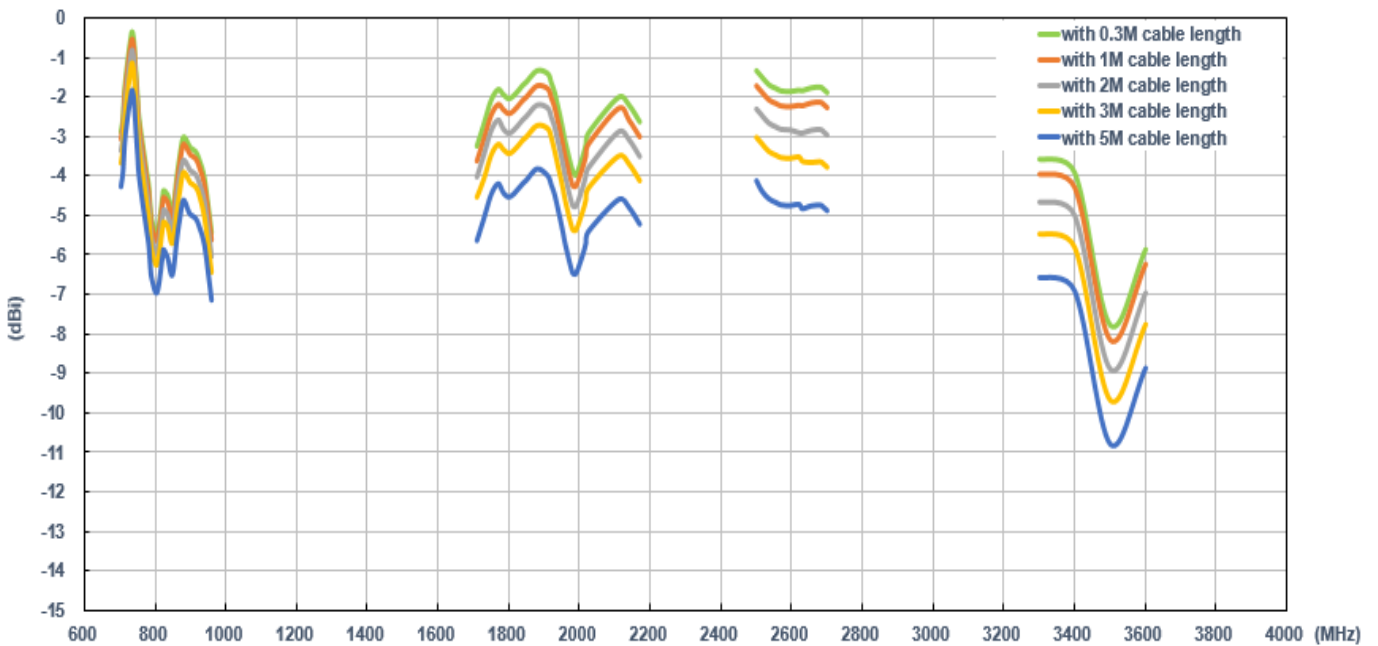

### 7.2.8 Peak Gain (MIMO\_1 in free space)

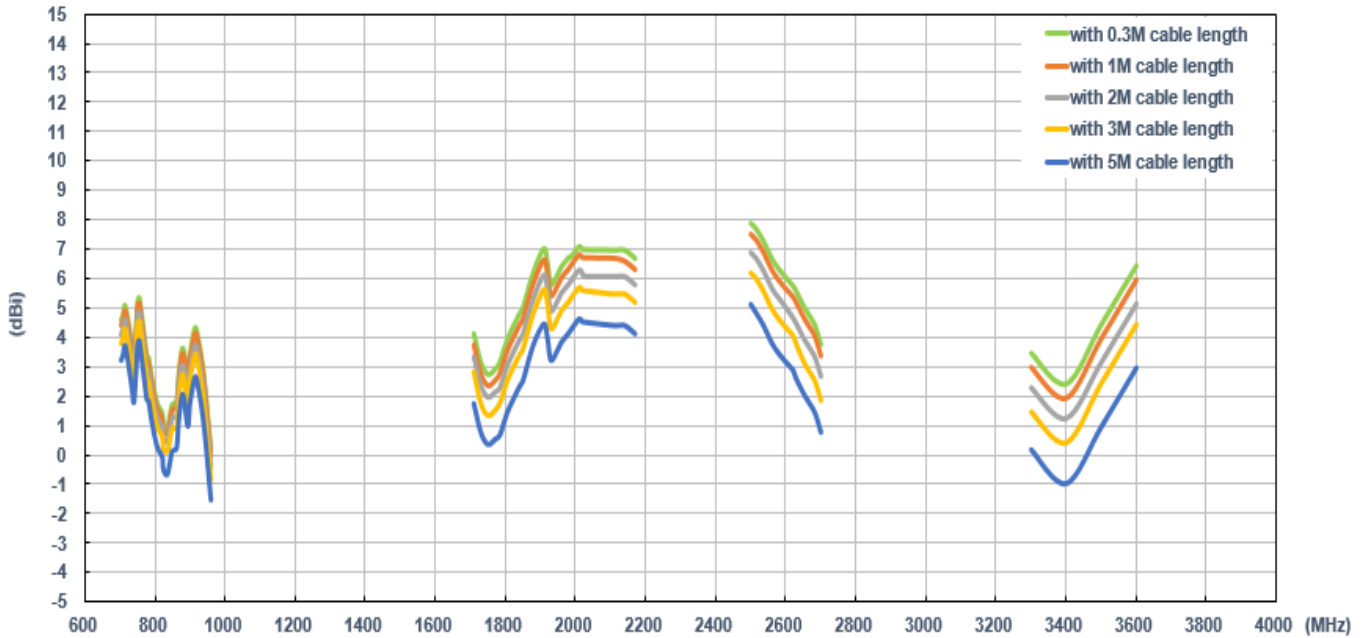

### 7.2.9 Peak Gain (MIMO\_2 in free space)

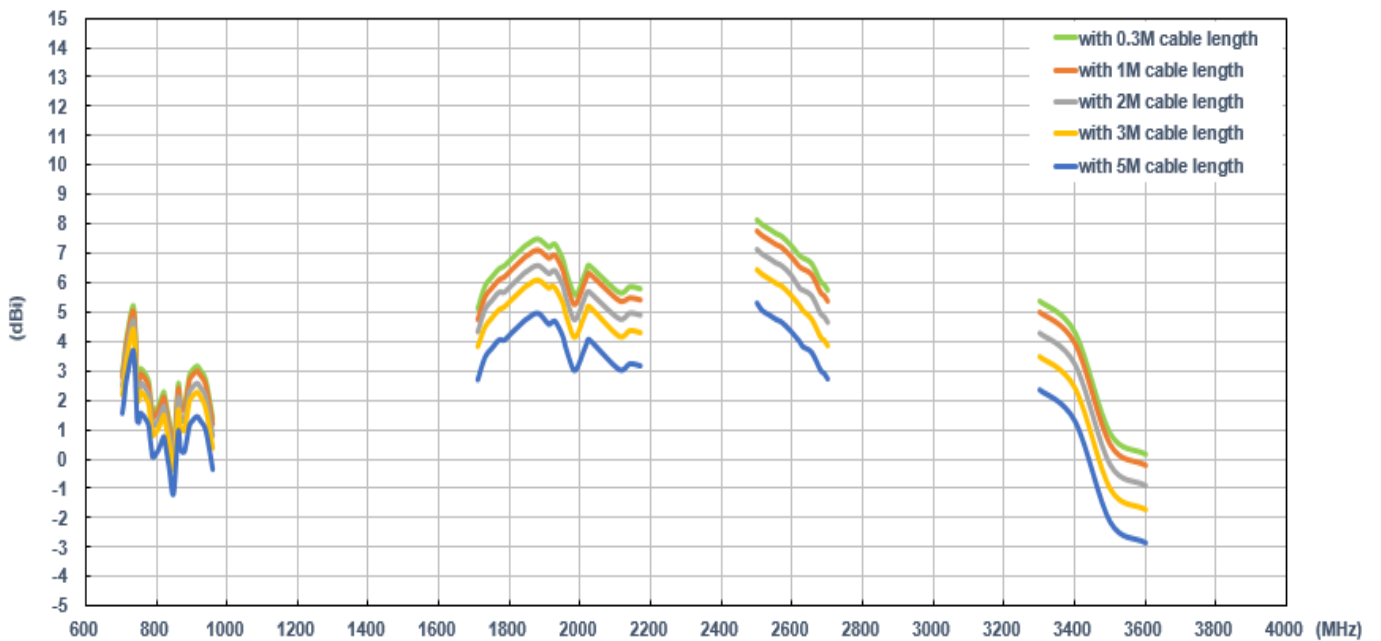



Taoglas makes no warranties based on the accuracy or completeness of the contents of this document and reserves the right to make changes to specifications and product descriptions at any time. Taoglas reserves all rights to this document and the information contained herein.

Reproduction, use or disclosure to third parties without express permission is strictly prohibited.

Copyright © Taoglas