

# IRF7757PbF

HEXFET® Power MOSFET

- Ultra Low On-Resistance
- Dual N-Channel MOSFET
- Very Small SOIC Package
- Low Profile (< 1.2mm)
- Available in Tape & Reel
- Common Drain Configuration
- Lead-Free

$V_{DSS}$	$R_{DS(on)}$ max (m $\Omega$ )	$I_D$
<b>20V</b>	35 @ $V_{GS} = 4.5V$	4.8A
	40 @ $V_{GS} = 2.5V$	3.8A

## Description

HEXFET® Power MOSFETs from International Rectifier utilize advanced processing techniques to achieve extremely low on-resistance per silicon area. This benefit, combined with the ruggedized device design, that International Rectifier is well known for, provides the designer with an extremely efficient and reliable device for battery and load management.

The TSSOP-8 package has 45% less footprint area than the standard SO-8. This makes the TSSOP-8 an ideal device for applications where printed circuit board space is at a premium. The low profile (<1.2mm) allows it to fit easily into extremely thin environments such as portable electronics and PCMCIA cards.

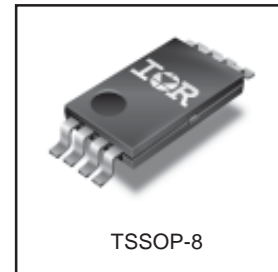
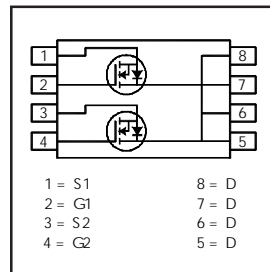

## Absolute Maximum Ratings

	Parameter	Max.	Units
$V_{DS}$	Drain- Source Voltage	20	V
$I_D$ @ $T_A = 25^\circ C$	Continuous Drain Current, $V_{GS}$ @ 4.5V	4.8	A
$I_D$ @ $T_A = 70^\circ C$	Continuous Drain Current, $V_{GS}$ @ 4.5V	3.9	
$I_{DM}$	Pulsed Drain Current ①	19	
$P_D$ @ $T_A = 25^\circ C$	Power Dissipation ③	1.2	W
$P_D$ @ $T_A = 70^\circ C$	Power Dissipation ③	0.76	
	Linear Derating Factor	9.5	mW/°C
$V_{GS}$	Gate-to-Source Voltage	$\pm 12$	V
$T_J, T_{STG}$	Junction and Storage Temperature Range	-55 to + 150	°C

## Thermal Resistance

	Parameter	Max.	Units
$R_{\theta JA}$	Maximum Junction-to-Ambient ③	105	°C/W

# IRF7757PbF

International  
IR Rectifier

## Electrical Characteristics @ $T_J = 25^\circ\text{C}$ (unless otherwise specified)

	Parameter	Min.	Typ.	Max.	Units	Conditions
$V_{(BR)DSS}$	Drain-to-Source Breakdown Voltage	20	—	—	V	$V_{GS} = 0V, I_D = 250\mu A$
$\Delta V_{(BR)DSS}/\Delta T_J$	Breakdown Voltage Temp. Coefficient	—	0.013	—	V/°C	Reference to $25^\circ\text{C}, I_D = 1\text{mA}$
$R_{DS(on)}$	Static Drain-to-Source On-Resistance	—	—	35	m $\Omega$	$V_{GS} = 4.5V, I_D = 4.8A$ ②
		—	—	40		$V_{GS} = 2.5V, I_D = 3.8A$ ②
$V_{GS(th)}$	Gate Threshold Voltage	0.60	—	1.2	V	$V_{DS} = V_{GS}, I_D = 250\mu A$
$g_{fs}$	Forward Transconductance	11	—	—	S	$V_{DS} = 10V, I_D = 4.8A$
$I_{DSS}$	Drain-to-Source Leakage Current	—	—	1.0	$\mu A$	$V_{DS} = 16V, V_{GS} = 0V$
		—	—	25		$V_{DS} = 16V, V_{GS} = 0V, T_J = 70^\circ\text{C}$
$I_{GSS}$	Gate-to-Source Forward Leakage	—	—	100	nA	$V_{GS} = 12V$
	Gate-to-Source Reverse Leakage	—	—	-100		$V_{GS} = -12V$
$Q_g$	Total Gate Charge	—	15	23	nC	$I_D = 4.8A$
$Q_{gs}$	Gate-to-Source Charge	—	2.5	—		$V_{DS} = 16V$
$Q_{gd}$	Gate-to-Drain ("Miller") Charge	—	4.8	—		$V_{GS} = 4.5V$
$t_{d(on)}$	Turn-On Delay Time	—	9.5	—	ns	$V_{DD} = 10V$ ②
$t_r$	Rise Time	—	9.2	—		$I_D = 1.0A$
$t_{d(off)}$	Turn-Off Delay Time	—	36	—		$R_G = 6.2\Omega$
$t_f$	Fall Time	—	14	—		$V_{GS} = 4.5V$
$C_{iss}$	Input Capacitance	—	1340	—	pF	$V_{GS} = 0V$
$C_{oss}$	Output Capacitance	—	180	—		$V_{DS} = 15V$
$C_{riss}$	Reverse Transfer Capacitance	—	132	—		$f = 1.0\text{MHz}$

## Source-Drain Ratings and Characteristics

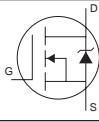
	Parameter	Min.	Typ.	Max.	Units	Conditions
$I_S$	Continuous Source Current (Body Diode)	—	—	1.2	A	MOSFET symbol showing the integral reverse p-n junction diode. 
$I_{SM}$	Pulsed Source Current (Body Diode) ①	—	—	19		
$V_{SD}$	Diode Forward Voltage	—	—	1.2	V	$T_J = 25^\circ\text{C}, I_S = 1.2A, V_{GS} = 0V$ ②
$t_{rr}$	Reverse Recovery Time	—	20	30	ns	$T_J = 25^\circ\text{C}, I_F = 1.2A$
$Q_{rr}$	Reverse Recovery Charge	—	10	15	nC	$di/dt = 100A/\mu s$ ②

### Notes:

① Repetitive rating; pulse width limited by max. junction temperature.

② Pulse width  $\leq 400\mu s$ ; duty cycle  $\leq 2\%$ .

③ Surface mounted on 1 in square Cu board

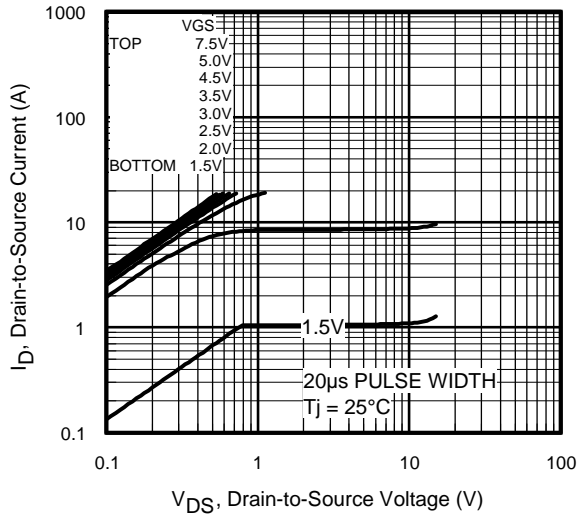

**Fig 1.** Typical Output Characteristics

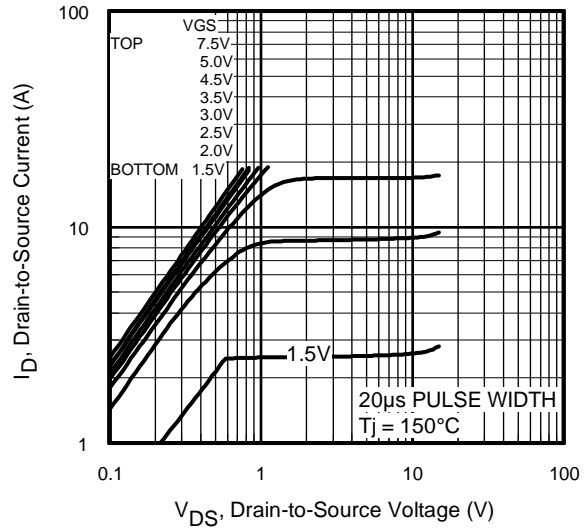

**Fig 2.** Typical Output Characteristics

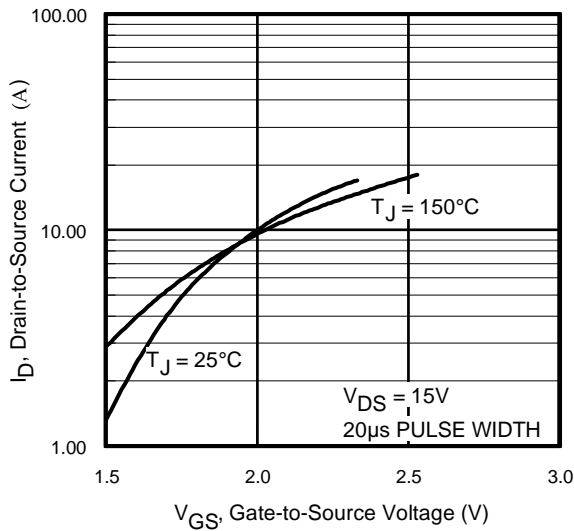

**Fig 3.** Typical Transfer Characteristics

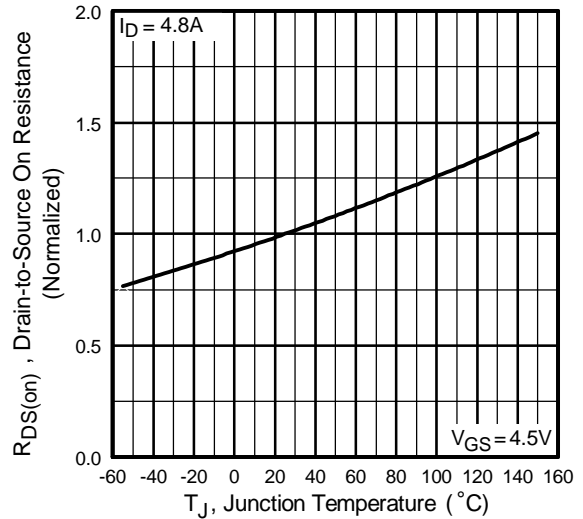

**Fig 4.** Normalized On-Resistance Vs. Temperature

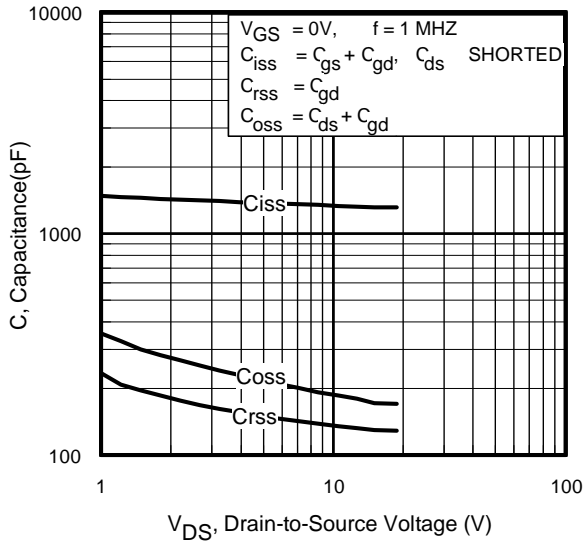

**Fig 5.** Typical Capacitance Vs. Drain-to-Source Voltage

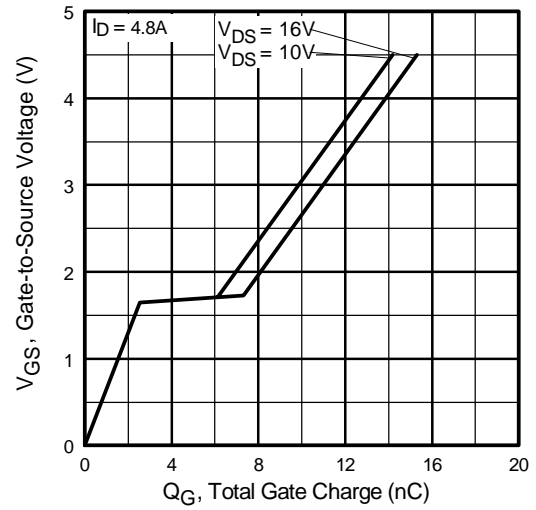

**Fig 6.** Typical Gate Charge Vs. Gate-to-Source Voltage

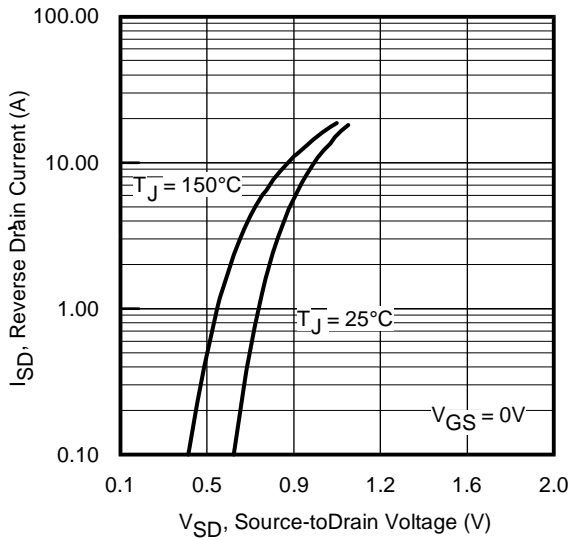

**Fig 7.** Typical Source-Drain Diode Forward Voltage

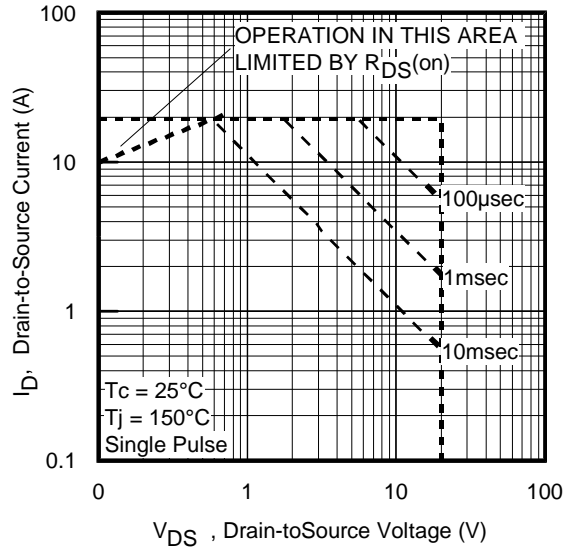

**Fig 8.** Maximum Safe Operating Area

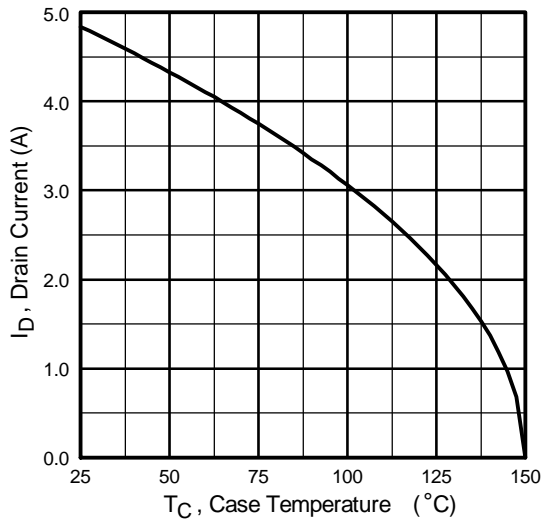

**Fig 9.** Maximum Drain Current Vs. Case Temperature

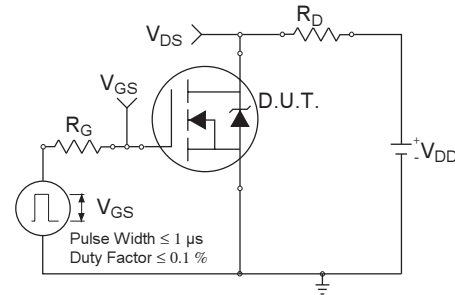

**Fig 10a.** Switching Time Test Circuit

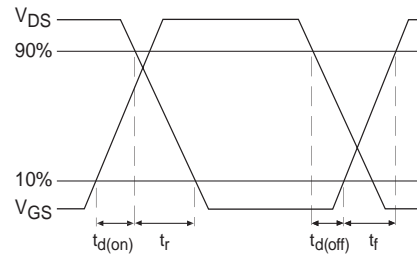

**Fig 10b.** Switching Time Waveforms

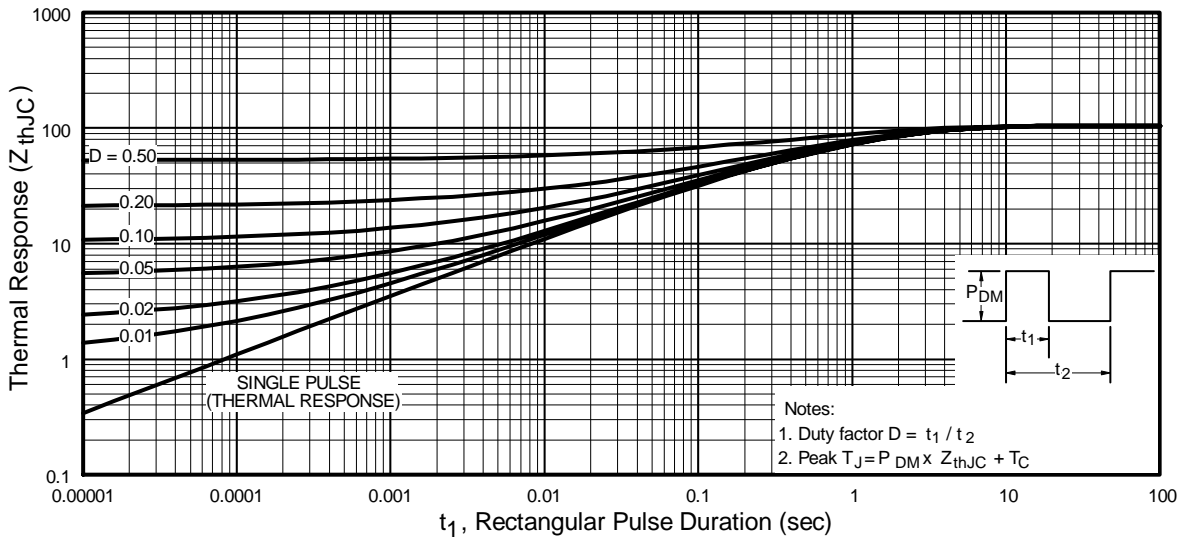

**Fig 11.** Typical Effective Transient Thermal Impedance, Junction-to-Ambient

# IRF7757PbF

International  
**IR** Rectifier

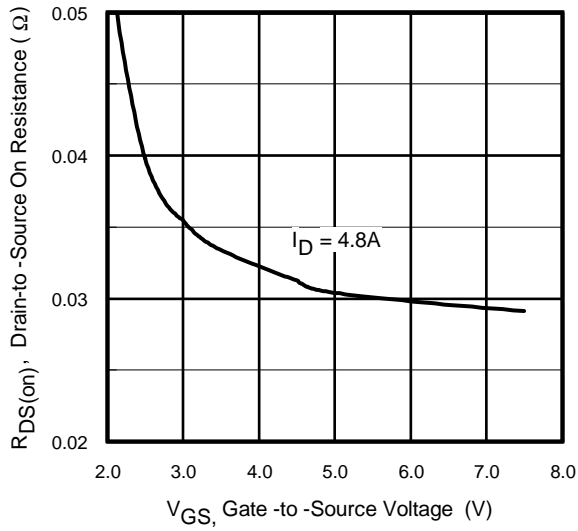

**Fig 12.** Typical On-Resistance Vs. Gate Voltage

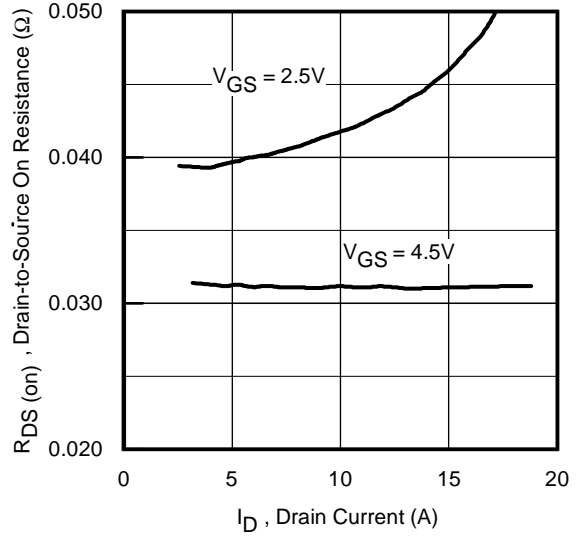

**Fig 13.** Typical On-Resistance Vs. Drain Current

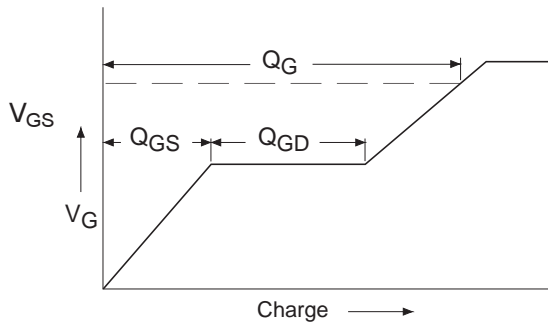

**Fig 14a.** Basic Gate Charge Waveform

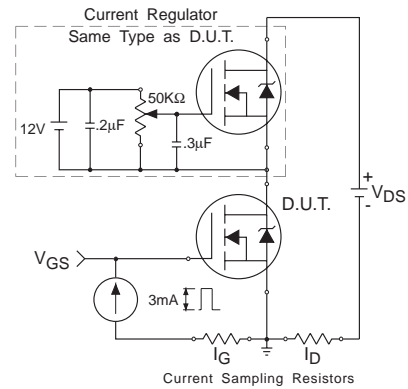

**Fig 14b.** Gate Charge Test Circuit

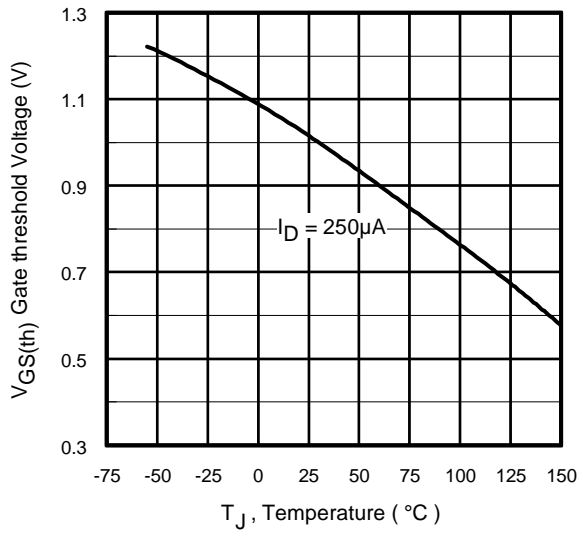

**Fig 15.** Typical Threshold Voltage Vs. Junction Temperature

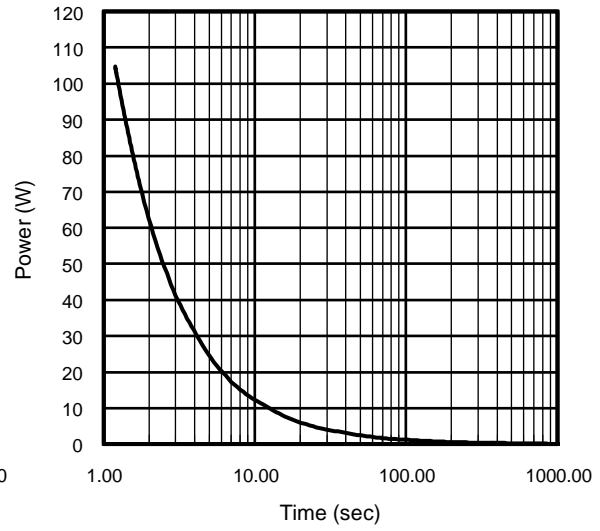

**Fig 16.** Typical Power Vs. Time

# IRF7757PbF

International  
**IR** Rectifier

## TSSOP8 Package Outline

Dimensions are shown in millimeters (inches)

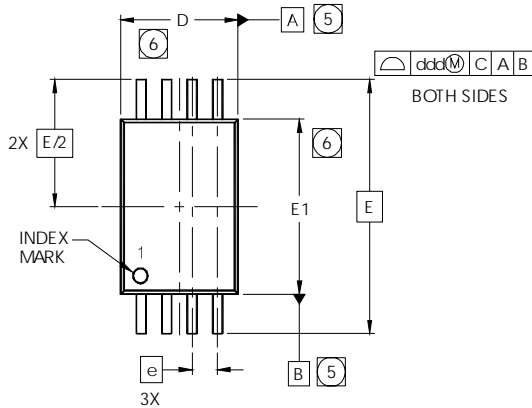

SYMBOL	MO-153AA DIMENSIONS					
	MILLIMETERS			INCHES		
	MIN	NOM	MAX	MIN	NOM	MAX
A	---	---	1.20	---	---	.0472
A1	0.05	---	0.15	.0020	---	.0059
A2	0.80	1.00	1.05	.032	.039	.041
b	0.19	---	0.30	.0075	---	.0118
c	0.09	---	0.20	.0036	---	.0078
D	2.90	3.00	3.10	.115	.118	.122
E	6.40 BSC			.251 BSC		
E1	4.30	4.40	4.50	.170	.173	.177
e	0.65 BSC			.0256		
L	0.45	0.60	0.75	.0178	.0236	.0290
L1	0.25 BSC			.010 BSC		
θ	0°	---	8°	0°	---	8°
aaa	0.10				.0039	
bbb	0.10				.0039	
ccc	0.05				.0019	
ddd	0.20				.0078	

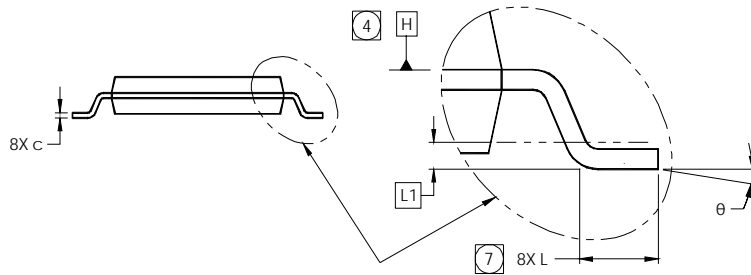
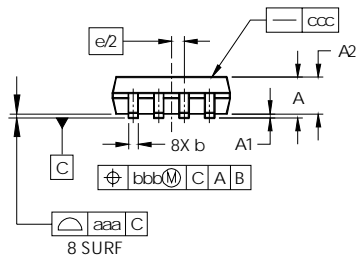

### LEAD ASSIGNMENTS



### NOTES

1. DIMENSIONING AND TOLERANCING PER ASME Y14.5M-1994.
2. DIMENSIONS ARE SHOWN IN MILLIMETERS AND INCHES.
3. CONTROLLING DIMENSION: MILLIMETER.
4. DATUM PLANE H IS LOCATED AS SHOWN.
5. DATUM A AND B TO BE DETERMINED AT DATUM PLANE H.
6. DIMENSIONS D AND E1 ARE MEASURED AT DATUM PLANE H.
7. DIMENSION L IS THE LEAD LENGTH FOR SOLDERING TO A SUBSTRATE.
8. OUTLINE CONFORMS TO JEDEC OUTLINE MO-153AA.



## TSSOP8 Part Marking Information

EXAMPLE: THIS IS AN IRF7702

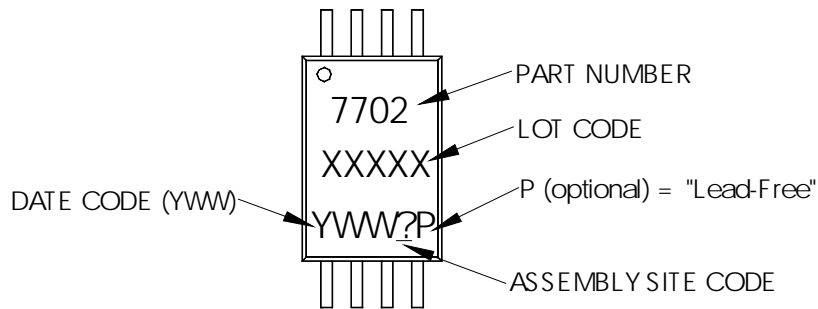

## TSSOP-8 Tape and Reel Information

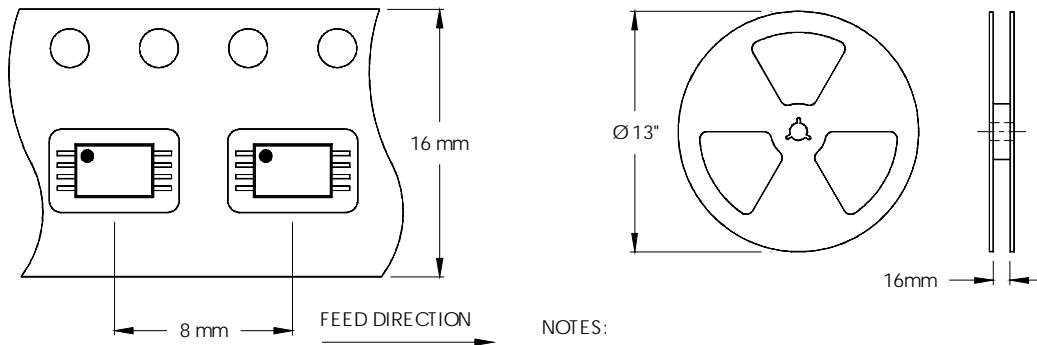

NOTES:

1. TAPE & REEL OUTLINE CONFORMS TO EIA-481 & EIA-541.

Data and specifications subject to change without notice.  
 This product has been designed and qualified for the consumer market.  
 Qualification Standards can be found on IR's Web site.