

Important notice

Dear Customer,

On 7 February 2017 the former NXP Standard Product business became a new company with the tradename **Nexperia**. Nexperia is an industry leading supplier of Discrete, Logic and PowerMOS semiconductors with its focus on the automotive, industrial, computing, consumer and wearable application markets

In data sheets and application notes which still contain NXP or Philips Semiconductors references, use the references to Nexperia, as shown below.

Instead of <http://www.nxp.com>, <http://www.philips.com/> or <http://www.semiconductors.philips.com/>, use <http://www.nexperia.com>

Instead of sales.addresses@www.nxp.com or sales.addresses@www.semiconductors.philips.com, use salesaddresses@nexperia.com (email)

Replace the copyright notice at the bottom of each page or elsewhere in the document, depending on the version, as shown below:

- © NXP N.V. (year). All rights reserved or © Koninklijke Philips Electronics N.V. (year). All rights reserved

Should be replaced with:

- © **Nexperia B.V. (year). All rights reserved.**

If you have any questions related to the data sheet, please contact our nearest sales office via e-mail or telephone (details via salesaddresses@nexperia.com). Thank you for your cooperation and understanding,

Kind regards,

Team Nexperia

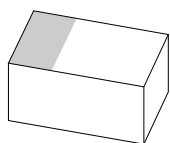

PESD5V0S1BSF

Ultra low profile bidirectional low capacitance
ESD protection diode

Rev. 2 — 18 February 2011

Product data sheet

1. Product profile

1.1 General description

Low capacitance bidirectional ElectroStatic Discharge (ESD) protection diode in a SOD962 leadless ultra small Surface-Mounted Device (SMD) package designed to protect one signal line from the damage caused by ESD and other transients.

1.2 Features and benefits

- Pb-free, Restriction of Hazardous Substances (RoHS) compliant and free of halogen and antimony (Dark Green compliant)
- Bidirectional ESD protection of one line
- Low diode capacitance $C_d = 35$ pF
- ESD protection up to ± 30 kV according IEC 61000-4-2
- Ultra small SMD package
- Symmetrical breakdown voltage

1.3 Applications

- Cellular handsets and accessories
- Portable electronics
- Communication systems
- Computers and peripherals

1.4 Quick reference data

Table 1. Quick reference data

$T_{amb} = 25$ °C unless otherwise specified.

Symbol	Parameter	Conditions	Min	Typ	Max	Unit
V_{RWM}	reverse standoff voltage		-5	-	5	V
C_d	diode capacitance	$f = 1$ MHz; $V_R = 0$ V [1]	25	35	45	pF

[1] This parameter is guaranteed by design.



2. Pinning information

Table 2. Pinning

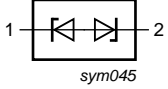
Pin	Description	Simplified outline	Graphic symbol
1	cathode (diode 1)	 <p>Transparent top view</p>	 <p>sym045</p>
2	cathode (diode 2)		

3. Ordering information

Table 3. Ordering information

Type number	Package		
	Name	Description	Version
PESD5V0S1BSF -		leadless ultra small package; 2 terminals; body 0.6 × 0.3 × 0.3 mm	SOD962

4. Marking

Table 4. Marking codes

Type number	Marking code
PESD5V0S1BSF	S

5. Limiting values

Table 5. Limiting values

In accordance with the Absolute Maximum Rating System (IEC 60134).

Symbol	Parameter	Conditions	Min	Max	Unit
P_{PP}	peak pulse power	$t_p = 8/20 \mu s$	[1][2] -	100	W
I_{PP}	peak pulse current	$t_p = 8/20 \mu s$	[1][2] -	8	A
T_j	junction temperature		-	150	°C
T_{amb}	ambient temperature		-55	+150	°C
T_{stg}	storage temperature		-65	+150	°C

[1] Non-repetitive current pulse 8/20 μs exponentially decaying waveform according to IEC 61000-4-5; see [Figure 1](#).

[2] Measured from pin 1 to pin 2.

Table 6. ESD maximum ratings

Symbol	Parameter	Conditions	Min	Max	Unit
V_{ESD}	electrostatic discharge voltage	IEC 61000-4-2 (contact discharge)	[1][2] -	30	kV
		IEC 61000-4-2 (air discharge)	-	30	kV
		MIL-STD-883 (human body model)	-	30	kV

[1] Measured from pin 1 to pin 2.

[2] Device stressed with ten non-repetitive ESD pulses; see [Figure 2](#).

Table 7. ESD standards compliance

Standard	Conditions
IEC 61000-4-2, level 4 (ESD)	> 15 kV (air); > 8 kV (contact)
MIL-STD-883; class 3 (human body model)	> 4 kV

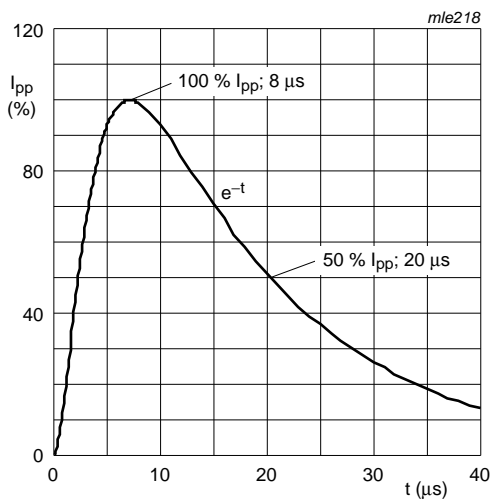

Fig 1. 8/20 μ s pulse waveform according to IEC 61000-4-5

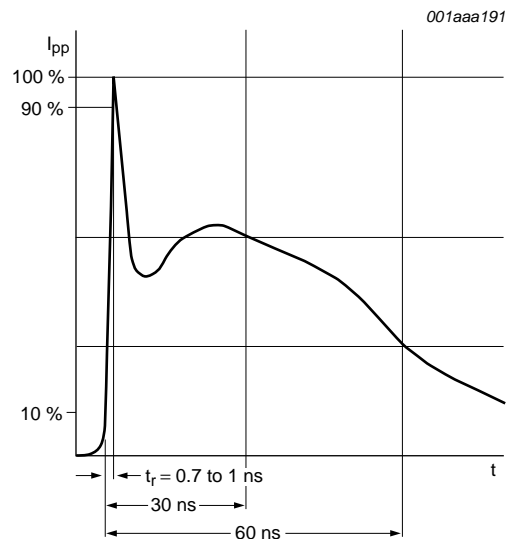

Fig 2. ESD pulse waveform according to IEC 61000-4-2

6. Characteristics

Table 8. Characteristics

$T_{amb} = 25\text{ }^{\circ}\text{C}$ unless otherwise specified.

Symbol	Parameter	Conditions	Min	Typ	Max	Unit	
Per diode							
V_{RWM}	reverse standoff voltage		-5	-	5	V	
I_{RM}	reverse leakage current	$V_{RWM} = 5\text{ V}$	-	1	100	nA	
V_{CL}	clamping voltage	$I_{PP} = 1\text{ A}$	[1][2]	-	-	12	V
		$I_{PP} = 8\text{ A}$	[1][2]	-	-	15.5	V
V_{BR}	breakdown voltage	$I_R = 1\text{ mA}$	[3]	6	-	10	V
		$I_R = -1\text{ mA}$	[3]	-10	-	-6	V
C_d	diode capacitance	$f = 1\text{ MHz}$	[4]				
		$V_R = 0\text{ V}$		25	35	45	pF
		$V_R = 2.5\text{ V}$		-	26.5	35	pF
		$V_R = 5\text{ V}$		-	23.7	31	pF
L_S	series inductance		[5]	-	0.05	-	nH
R_{dyn}	dynamic resistance		[6]	-	0.28	-	Ω

- [1] Non-repetitive current pulse 8/20 μs exponentially decaying waveform according to IEC 61000-4-5; see [Figure 1](#).
- [2] Measured from pin 1 to pin 2.
- [3] Breakdown voltage is always symmetrical within the characterized range, which means no difference in breakdown voltage from pin 1 to pin 2 and vice versa.
- [4] This parameter is guaranteed by design.
- [5] Calculated from S-parameter values.
- [6] Non-repetitive current pulse, Transmission Line Pulse (TLP) $t_p = 100\text{ ns}$; square pulse; ANS/IESD STM5.1-2008.

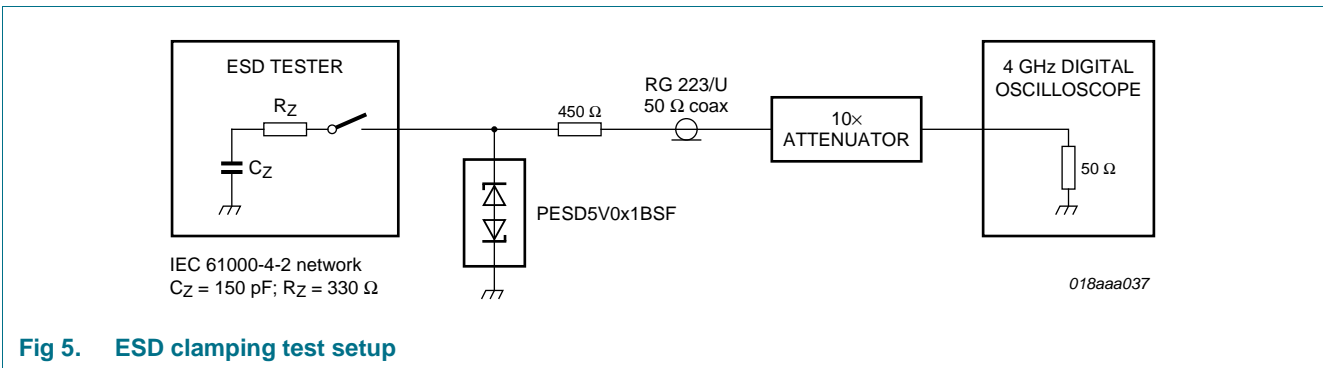
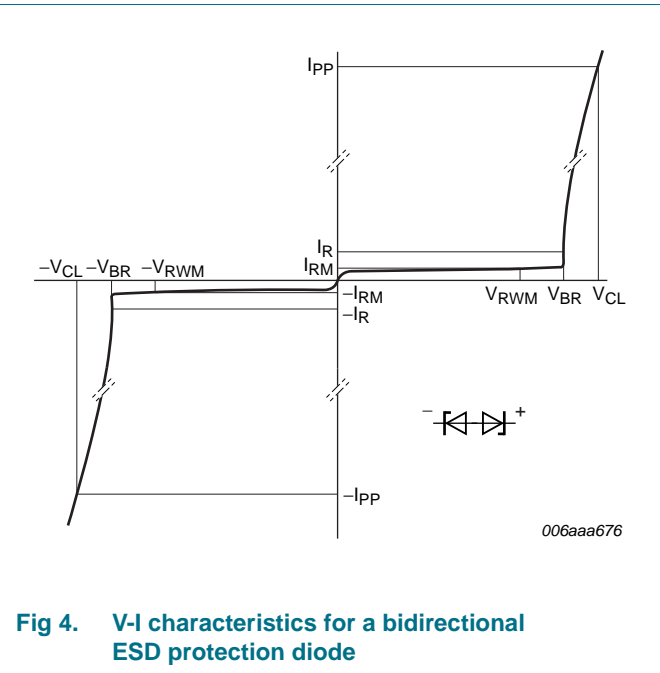
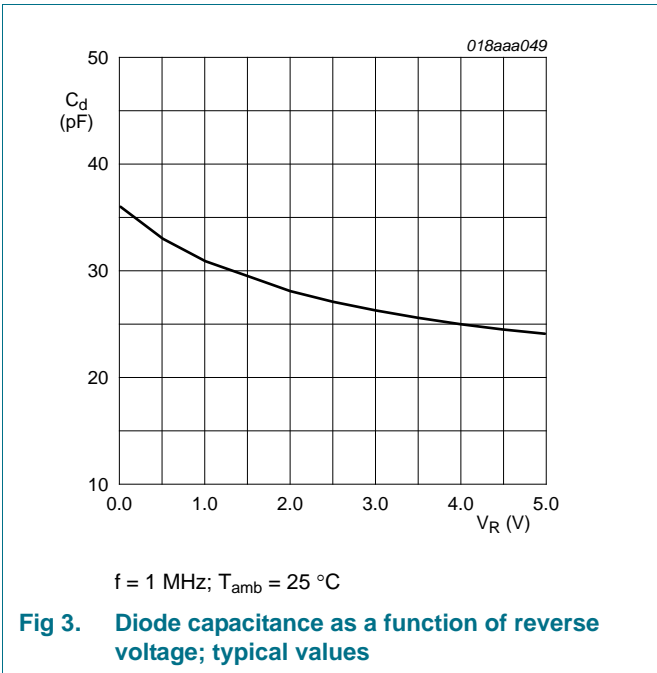

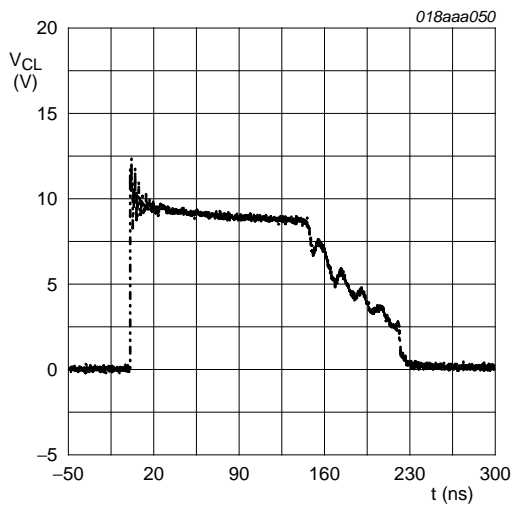

$f = 1 \text{ MHz}; T_{amb} = 25 \text{ }^\circ\text{C}$

Fig 6. Clamped +1 kV ESD pulse waveform (IEC 61000-4-2 network)

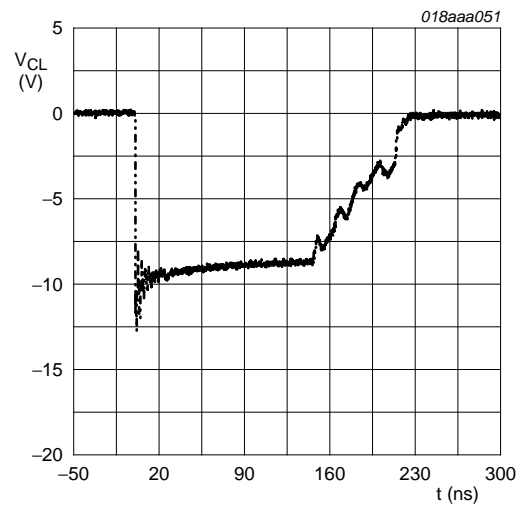

$f = 1 \text{ MHz}; T_{amb} = 25 \text{ }^\circ\text{C}$

Fig 7. Clamped -1 kV ESD pulse waveform (IEC 61000-4-2 network)

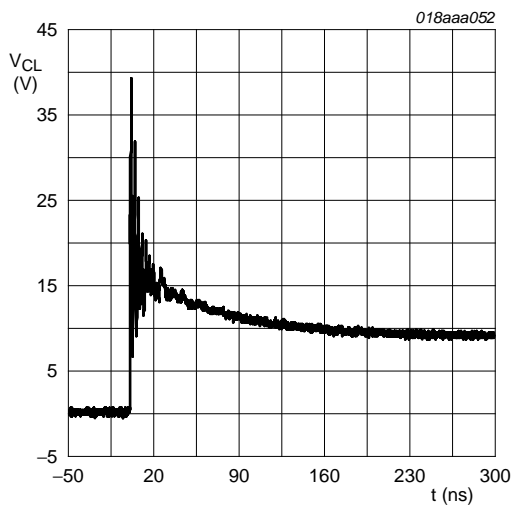

$f = 1 \text{ MHz}; T_{amb} = 25 \text{ }^\circ\text{C}$

Fig 8. Clamped +8 kV ESD pulse waveform (IEC 61000-4-2 network)

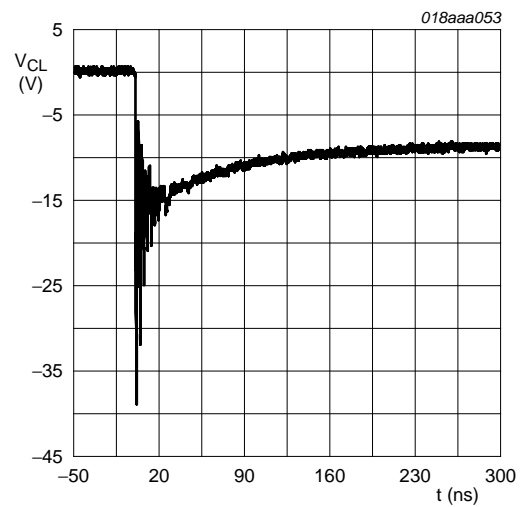

$f = 1 \text{ MHz}; T_{amb} = 25 \text{ }^\circ\text{C}$

Fig 9. Clamped -8 kV ESD pulse waveform (IEC 61000-4-2 network)

7. Application information

The PESD5V0S1BSF is designed for the protection of one data or signal line from the damage caused by ESD and/or other surge pulses. The device may be used on lines where the signal polarities are both, positive and negative with respect to ground. It provides protection against surges with up to 100 W per line.

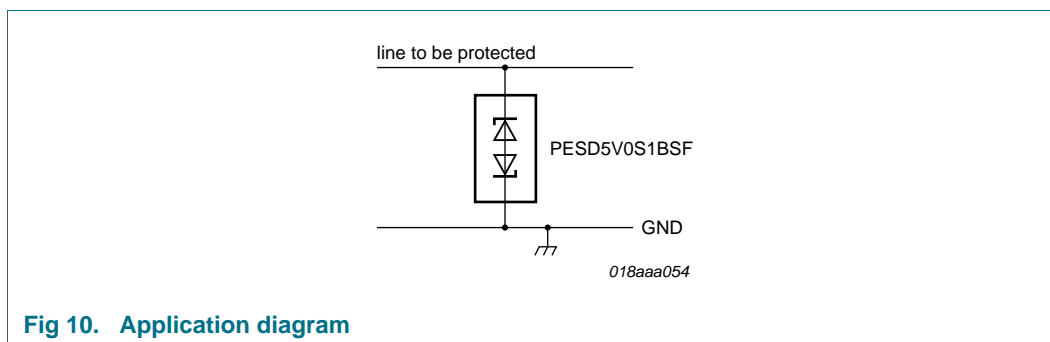

Fig 10. Application diagram

Circuit board layout and protection device placement

Circuit board layout is critical for the suppression of ESD and Electrical Fast Transient (EFT). The following guidelines are recommended:

1. Place the device as close to the input terminal or connector as possible
2. The path length between the device and the protected line should be minimized
3. Avoid running protected conductors in parallel with unprotected conductors
4. Minimize all Printed-Circuit Board (PCB) conductive loops including power and ground loops
5. Minimize the length of the transient return path to ground
6. Avoid using shared transient return paths to a common ground point
7. Ground planes should be used whenever possible. For multilayer PCBs, use ground vias.

8. Package outline

Leadless ultra small package; 2 terminals; body 0.6 x 0.3 x 0.3 mm

SOD962

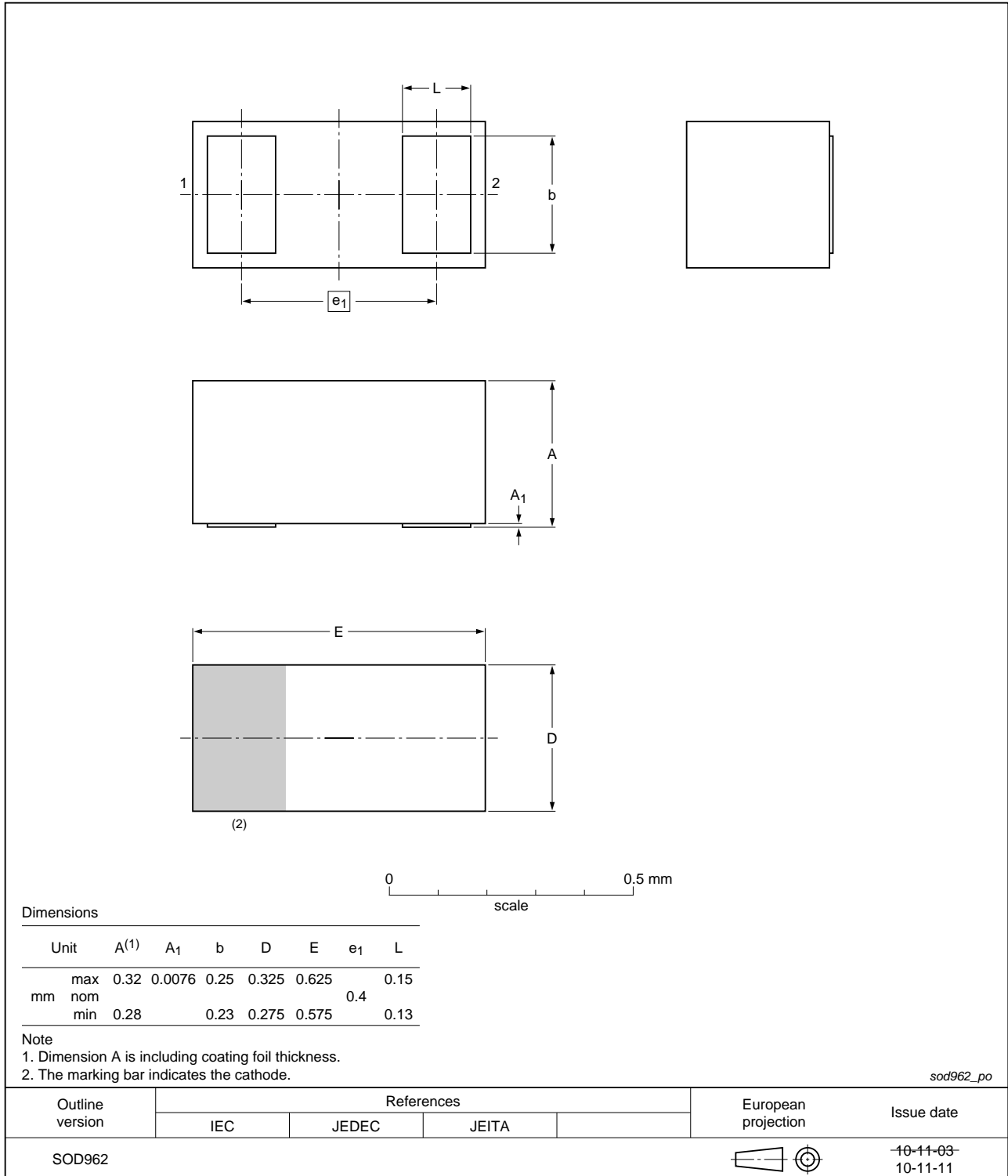

Fig 11. Package outline PESD5V0S1BSF (SOD962)

9. Packing information

Table 9. Packing methods

The indicated -xxx are the last three digits of the 12NC ordering code.^[1]

Type number	Package	Description	Packing quantity
			9000
PESD5V0S1BSF	SOD962	2 mm pitch, 8 mm tape and reel	-315

[1] For further information and the availability of packing methods, see [Section 13](#).

10. Soldering

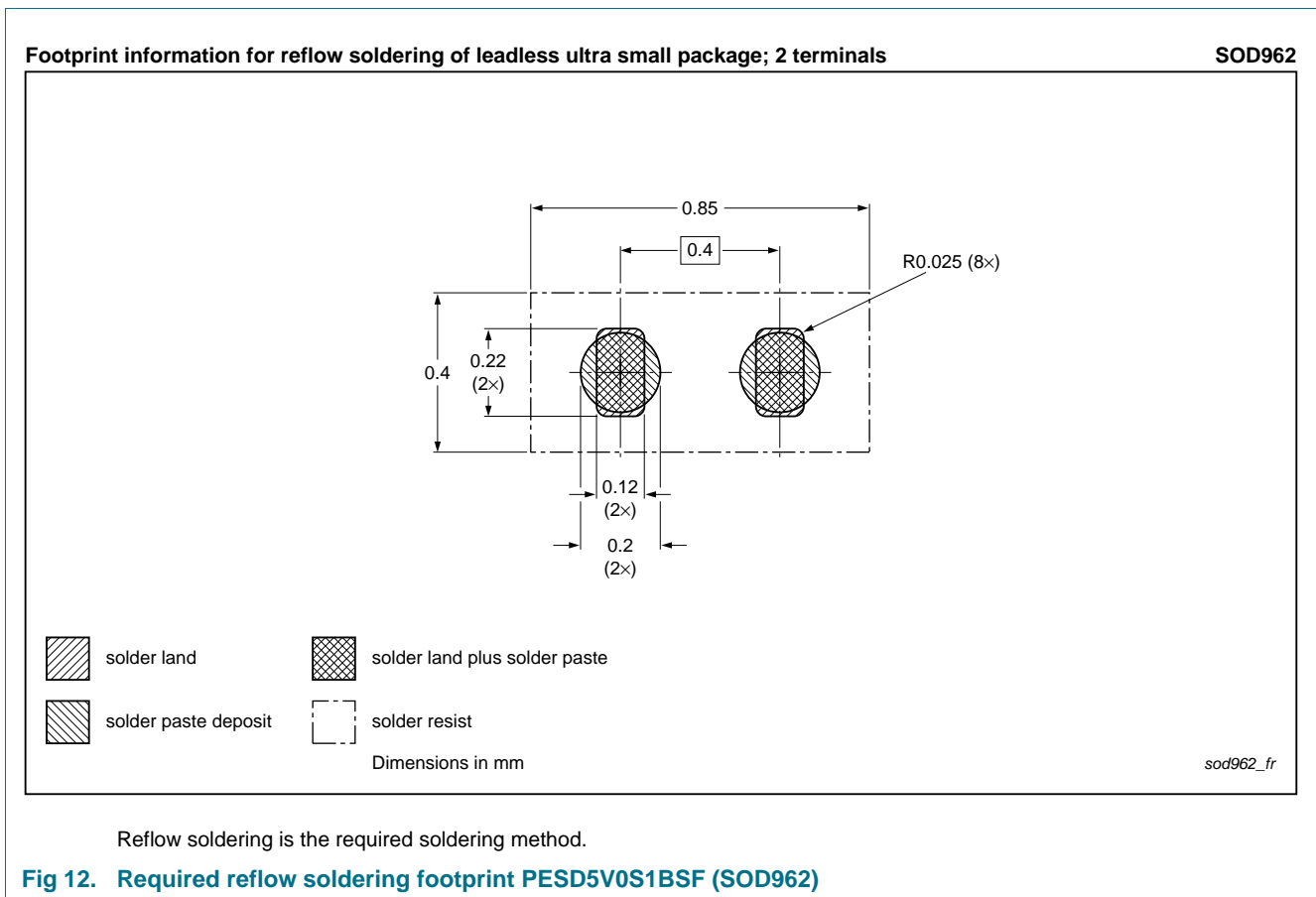

Based on results of board mount testing, NXP Semiconductors requires the following soldering guidelines:

1. Soldering footprint as indicated in [Figure 12](#): solder paste has to cover the whole solder land area.
2. Non-solder mask defined (copper-defined) solder lands.
3. Minimum stencil thickness of 100 μm .
4. Paste type 4 or smaller sphere size.
5. Pick and placement accuracy of $\pm 50 \mu\text{m}$.

11. Revision history

Table 10. Revision history

Document ID	Release date	Data sheet status	Change notice	Supersedes
PESD5V0S1BSF v.2	20110218	Product data sheet	-	PESD5V0S1BSF v.1
Modifications:	<ul style="list-style-type: none">• Section 1.2 “Features and benefits”: updated• Table 1 and Table 8: V_{RWM} and C_d values updated.• Table 6 “ESD maximum ratings”: updated.• Table 8: V_{BR} updated.• Figure 12: title amended.			
PESD5V0S1BSF v.1	20101112	Preliminary data sheet	-	-

12. Legal information

12.1 Data sheet status

Document status ^{[1][2]}	Product status ^[3]	Definition
Objective [short] data sheet	Development	This document contains data from the objective specification for product development.
Preliminary [short] data sheet	Qualification	This document contains data from the preliminary specification.
Product [short] data sheet	Production	This document contains the product specification.

[1] Please consult the most recently issued document before initiating or completing a design.

[2] The term 'short data sheet' is explained in section "Definitions".

[3] The product status of device(s) described in this document may have changed since this document was published and may differ in case of multiple devices. The latest product status information is available on the Internet at URL <http://www.nxp.com>.

12.2 Definitions

Draft — The document is a draft version only. The content is still under internal review and subject to formal approval, which may result in modifications or additions. NXP Semiconductors does not give any representations or warranties as to the accuracy or completeness of information included herein and shall have no liability for the consequences of use of such information.

Short data sheet — A short data sheet is an extract from a full data sheet with the same product type number(s) and title. A short data sheet is intended for quick reference only and should not be relied upon to contain detailed and full information. For detailed and full information see the relevant full data sheet, which is available on request via the local NXP Semiconductors sales office. In case of any inconsistency or conflict with the short data sheet, the full data sheet shall prevail.

Product specification — The information and data provided in a Product data sheet shall define the specification of the product as agreed between NXP Semiconductors and its customer, unless NXP Semiconductors and customer have explicitly agreed otherwise in writing. In no event however, shall an agreement be valid in which the NXP Semiconductors product is deemed to offer functions and qualities beyond those described in the Product data sheet.

12.3 Disclaimers

Limited warranty and liability — Information in this document is believed to be accurate and reliable. However, NXP Semiconductors does not give any representations or warranties, expressed or implied, as to the accuracy or completeness of such information and shall have no liability for the consequences of use of such information.

In no event shall NXP Semiconductors be liable for any indirect, incidental, punitive, special or consequential damages (including - without limitation - lost profits, lost savings, business interruption, costs related to the removal or replacement of any products or rework charges) whether or not such damages are based on tort (including negligence), warranty, breach of contract or any other legal theory.

Notwithstanding any damages that customer might incur for any reason whatsoever, NXP Semiconductors' aggregate and cumulative liability towards customer for the products described herein shall be limited in accordance with the *Terms and conditions of commercial sale* of NXP Semiconductors.

Right to make changes — NXP Semiconductors reserves the right to make changes to information published in this document, including without limitation specifications and product descriptions, at any time and without notice. This document supersedes and replaces all information supplied prior to the publication hereof.

Suitability for use — NXP Semiconductors products are not designed, authorized or warranted to be suitable for use in life support, life-critical or safety-critical systems or equipment, nor in applications where failure or

malfunction of an NXP Semiconductors product can reasonably be expected to result in personal injury, death or severe property or environmental damage. NXP Semiconductors accepts no liability for inclusion and/or use of NXP Semiconductors products in such equipment or applications and therefore such inclusion and/or use is at the customer's own risk.

Applications — Applications that are described herein for any of these products are for illustrative purposes only. NXP Semiconductors makes no representation or warranty that such applications will be suitable for the specified use without further testing or modification.

Customers are responsible for the design and operation of their applications and products using NXP Semiconductors products, and NXP Semiconductors accepts no liability for any assistance with applications or customer product design. It is customer's sole responsibility to determine whether the NXP Semiconductors product is suitable and fit for the customer's applications and products planned, as well as for the planned application and use of customer's third party customer(s). Customers should provide appropriate design and operating safeguards to minimize the risks associated with their applications and products.

NXP Semiconductors does not accept any liability related to any default, damage, costs or problem which is based on any weakness or default in the customer's applications or products, or the application or use by customer's third party customer(s). Customer is responsible for doing all necessary testing for the customer's applications and products using NXP Semiconductors products in order to avoid a default of the applications and the products or of the application or use by customer's third party customer(s). NXP does not accept any liability in this respect.

Limiting values — Stress above one or more limiting values (as defined in the Absolute Maximum Ratings System of IEC 60134) will cause permanent damage to the device. Limiting values are stress ratings only and (proper) operation of the device at these or any other conditions above those given in the Recommended operating conditions section (if present) or the Characteristics sections of this document is not warranted. Constant or repeated exposure to limiting values will permanently and irreversibly affect the quality and reliability of the device.

Terms and conditions of commercial sale — NXP Semiconductors products are sold subject to the general terms and conditions of commercial sale, as published at <http://www.nxp.com/profile/terms>, unless otherwise agreed in a valid written individual agreement. In case an individual agreement is concluded only the terms and conditions of the respective agreement shall apply. NXP Semiconductors hereby expressly objects to applying the customer's general terms and conditions with regard to the purchase of NXP Semiconductors products by customer.

No offer to sell or license — Nothing in this document may be interpreted or construed as an offer to sell products that is open for acceptance or the grant, conveyance or implication of any license under any copyrights, patents or other industrial or intellectual property rights.

Export control — This document as well as the item(s) described herein may be subject to export control regulations. Export might require a prior authorization from national authorities.

Quick reference data — The Quick reference data is an extract of the product data given in the Limiting values and Characteristics sections of this document, and as such is not complete, exhaustive or legally binding.

Non-automotive qualified products — Unless this data sheet expressly states that this specific NXP Semiconductors product is automotive qualified, the product is not suitable for automotive use. It is neither qualified nor tested in accordance with automotive testing or application requirements. NXP Semiconductors accepts no liability for inclusion and/or use of non-automotive qualified products in automotive equipment or applications.

In the event that customer uses the product for design-in and use in automotive applications to automotive specifications and standards, customer (a) shall use the product without NXP Semiconductors' warranty of the

product for such automotive applications, use and specifications, and (b) whenever customer uses the product for automotive applications beyond NXP Semiconductors' specifications such use shall be solely at customer's own risk, and (c) customer fully indemnifies NXP Semiconductors for any liability, damages or failed product claims resulting from customer design and use of the product for automotive applications beyond NXP Semiconductors' standard warranty and NXP Semiconductors' product specifications.

12.4 Trademarks

Notice: All referenced brands, product names, service names and trademarks are the property of their respective owners.

13. Contact information

For more information, please visit: <http://www.nxp.com>

For sales office addresses, please send an email to: salesaddresses@nxp.com

14. Contents

1	Product profile	1
1.1	General description	1
1.2	Features and benefits	1
1.3	Applications	1
1.4	Quick reference data	1
2	Pinning information	2
3	Ordering information	2
4	Marking	2
5	Limiting values	2
6	Characteristics	4
7	Application information	7
8	Package outline	8
9	Packing information	9
10	Soldering	9
11	Revision history	10
12	Legal information	11
12.1	Data sheet status	11
12.2	Definitions	11
12.3	Disclaimers	11
12.4	Trademarks	12
13	Contact information	12
14	Contents	13

Please be aware that important notices concerning this document and the product(s) described herein, have been included in section 'Legal information'.

© NXP B.V. 2011.

All rights reserved.

For more information, please visit: <http://www.nxp.com>

For sales office addresses, please send an email to: salesaddresses@nxp.com

Date of release: 18 February 2011

Document identifier: PESD5V0S1BSF