

Specification

Drawing No.	<i>EQM08-50C-00AF612-00</i>
Issued Date	May-06-2012

To Digi-Key

Note: In case of specification change, KYOCERA Part Number also will be changed.

Customer Part Number	
KYOCERA Part Number	KV7050B19.4400C3GD00
Remarks: This product is Pb-Free and RoHS compliant. Moisture Sensitivity Level (MSL): Level1	

Customer Acceptance

Please sign here and send one copy back to us.

Signature:	Accepted Date:
------------	----------------

Seller

KYOCERA Corporation

6 Takeda Tobadono-cho, Fushimi-ku, Kyoto,
Japan 612-8501
TEL: +81-75-604-3500
FAX: +81-75-604-3501

Manufacturer

KYOCERA Crystal Device Corporation

1-8-1 Izumihon-cho, Komae, Tokyo,
Japan 201-8648
TEL: +81-3-5497-3110
FAX: +81-3-5497-3208

Design Department	Quality Assurance	Approved by	Checked by	Issued by
KYOCERA Crystal Device Corporation Nagano Okaya Plant Clock Oscillator Division Application Engineering Section	<i>M. Morimoto</i>	<i>R. Mizutani</i>	<i>M. Matsumoto</i>	<i>T. Asakura</i>

Revision History

<i>Rev. No.</i>	Description of revise	<i>Issued Date</i>	<i>Approved by</i>	<i>Checked by</i>	<i>Issued by</i>
00	First Edition	May-06-2012	R. Mizutani	M. Matsumoto	T. Asakura

1. Scope

This specification shall be defined of the Clock Oscillator for the integrated circuits (ICs).

2. Customer Part Number

3. KYOCERA Part Number

KV7050B19.4400C3GD00

4. Electrical Characteristics

4-1. Absolute Maximum Rating

Item	Symbol	Rated Value	Units
Power Supply Voltage	V_{CC}	-0.5 to +7.0	V
Input Voltage	V_{IN}	-0.5 to $V_{CC} + 0.5$	V
Storage Temperature Range	T_{STG}	-55 to +90	°C

Note:

If the part is used beyond absolute maximum ratings, it may cause internal destruction. The part should be used under the recommended operating conditions the reliability of this part may be damaged if those conditions are exceeded.

4-2. Recommended Operating Conditions

Item	Symbol	Min	Typ	Max	Units	Remarks
Power Supply Voltage	V_{CC}	2.97	3.30	3.63	V	
Input Voltage	V_{IN}	0	---	V_{CC}	V	
Operating Temperature Range	T_{OPR}	-40	25	85	°C	

4-3. Electrical Characteristics

Item	Symbol	Min	Typ	Max	Units	Remarks
Output Frequency	f_o	---	19.44	---	MHz	
Frequency Tolerance @ $V_C=1.65V$	f_{tol}	-50	---	+50	ppm	Include initial tolerance, operating temperature range, rated power supply voltage change, load change, aging (1year @25°C), shock and vibration
Absolute Pull Range	APR	±100	---	---	ppm	
Linearity	Lin	-15	---	+15	%	
Control Voltage	V_C	0	1.65	3.3	V	
Current Consumption (Loaded)	I_{CC}	---	---	15	mA	
Disable/ Standby Current	I_{DE}	---	---	10	mA	
Symmetry (Duty Ratio)	SYM	45	50	55	%	@ 50% V_{CC}
Rise Time/ Fall Time (10% V_{CC} to 90% V_{CC})	Tr/ Tf	---	2	8	ns	
Output Voltage -"L"	V_{OL}	---	---	10% V_{CC}	V	
Output Voltage -"H"	V_{OH}	90% V_{CC}	---	---	V	
Output Load	CL	---	---	15	pF	C-MOS
Input Voltage -"L"	V_{IL}	---	---	30% V_{CC}	V	
Input Voltage -"H"	V_{IH}	70% V_{CC}	---	---	V	
Modulation BW	---	15	30	---	kHz	@ -3dB
Input Vc Impedance	---	100	120	---	kOhm	
Output Disable Time	t_{dis}	---	---	100	ns	
Output Enable Time	t_{ena}	---	---	100	ns	
				2	ms	80 < f_o ≤ 160MHz
Start up Time	t_{sta}	---	2	10	ms	@Minimum operating voltage to be 0sec
Phase Jitter	J_{Phase}	---	---	1	ps	BW: 12KHz to 20MHz
Phase Noise	---	27MHz(Typ.)			dBc/Hz	
		-70				
		-100				
		-130				
		-145				
		-152				
-158						
-158						

Note: All electrical characteristics have defined on the maximum loaded and recommended operating conditions.

Table 1



4-4. Measurement Condition

The reference temperature shall be 25±2°C. The measurement shall be performed at the temperature range of 5 °C to 35 °C unless otherwise the result is doubtful.

4-5. Measurement Circuit

The electrical characteristics shall be measured by test circuit "Fig. 1". Also jitter shall be measured by test circuit "Fig. 3".

4-6. Clock Timing Chart

The clock timing chart is "Fig. 2"

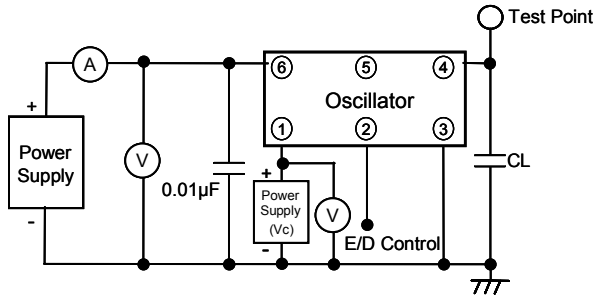

Fig.1 Test Circuits

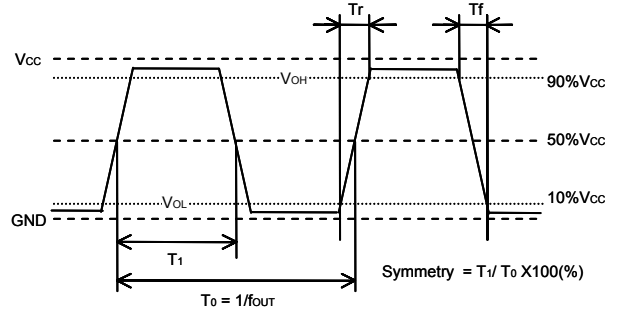
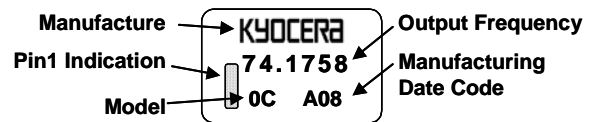
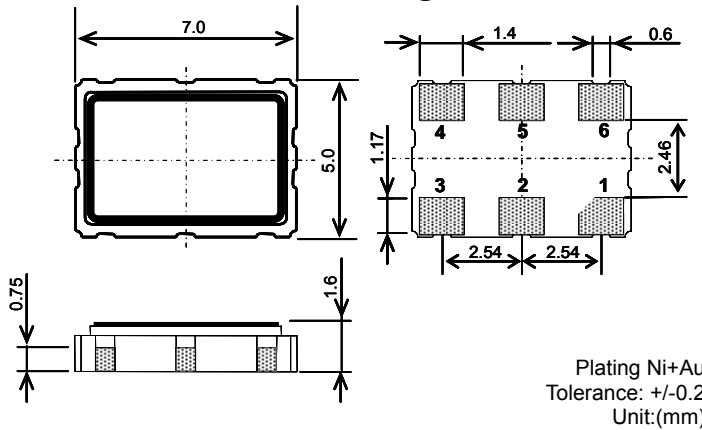

Fig.2 Clock Timing Chart (C-MOS Output)

5. Dimensions and Marking



Output Frequency

The output frequency is seven-digit including a decimal point. The frequency greater than the number of digits have rounded off. (E.g. 74.17582MHz → "74.1758")

Model

See Table 2

Manufacturing Date Code

- 1) Year Code (2000: "Z", 2001:"A", 2002: "B")
- 2) Weekly Code

Pad arrangement	
1	Vc Control
2	Enable/Disable
3	Case GND
4	Output
5	NC
6	Vcc

Enable/Disable Function	
Pad2	Pad4
OPEN	Active
"H" Level	Active
"L" Level	High Z

Stability		Model Code
Code	(ppm)	KV7050B19.4400C3GD00
G	±50(-40 to +85°C)	GC

Table 2

6. Parts Numbering Guide

KV7050B 19.4400 C 3 G D 00
 A B C D E F G

- A. Series (6pad SMD VCXO)
- B. Output Frequency
- C. Output
C: C-MOS
- D. Supply Voltage
3: 3.3V
- E. Frequency Tolerance*
G: ±50ppm

- F. Enable/Disable Function and Vc Input Impedance
D: E/D Func, Vc Imp. 100k min
- G. Suffix for Individual Requirements
(STD Specification is "00")

Packing (Tape & Reel 1,000pcs/Reel)

*Over All Conditions:

Include initial tolerance, operating temperature range, rated power supply voltage change, load change, aging (1year @25°C), shock and vibration



7. Environmental Characteristics

Items	Conditions	Criteria of Acceptance
7-1. Solderability	Soaking: 245±5°C, 5.0±0.5sec	Dipped portion: Minimum 95% coverage
7-2. Soldering Heat Resistance	Reflow soldering: Peak 260°C max, 10sec, Twice max Soldering iron: 380±5°C, 3+1/-0sec, Twice as one time for four pads	Without looseness or crack etc.
7-3. Temperature Cycle	100cycles: -55°C to +125°C (30minuts each/ cycle)	Clause 7-10 shall be satisfied.
7-4. Mechanical Shock (Pulse)	5 times 14,750m/sec ² (1,500G), Duration of pulse 0.5msec (MIL-STD-883D-2002.3 Condition B)	
7-5. Vibration	4 times each axis X, Y, Z: 20 to 2,000Hz and 2,000Hz to 20Hz/cycle Peak acceleration 196m/sec ² (20G) (MIL-STD-883D-2007.2 Condition A)	
7-6. High Temperature	1000 hours: Temperature: 85+5/-3°C	
7-7. Low Temperature	1000 hours: Temperature: -40+5/-3°C	
7-8. Humidity Cycle	10 cycles: Based on 1004 specifications (MIL-STD-883D-1004.7)	Clause 7-1 shall be satisfied.
7-9. Hermeticity 1 (Gross leak)	Soaking: 125°C, 5minutes	No bubbles appeared
7-10. Hermeticity 2 (Fine leak)	Measured by Helium Detector Equipment (MIL-STD-883D-1014.10 Condition A1)	5x10 ⁻⁹ Pa m ³ /sec max

After each testing, the parts shall be subjected to standard atmospheric conditions more than 2 hours. After that, the electrical characteristics shall be measured. The result of the test shall be satisfied **Table 1**.

Table 3

8. Recommended Land pattern and Soldering Guide

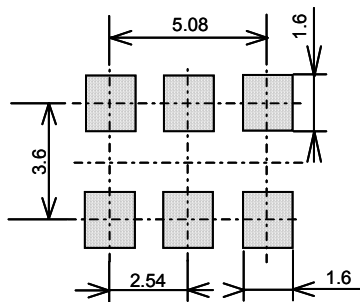

Unit: (mm)

Note:

Since the part doesn't have Bypass Capacitor between V_{CC} and GND, Please mount high frequency type capacitor 0.01 μ F and 10 μ F to the nearest position of oscillator.

Fig.3 Land pattern

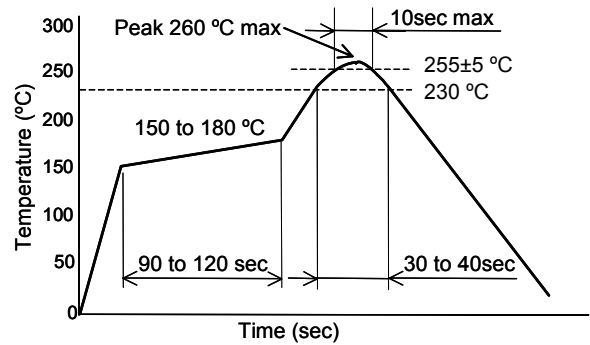

- Available Reflow times: Maximum twice

Fig.4 Reflow profile (Lead Free Available)

8-1. Soldering Iron Conditions

- Tip temperature of soldering iron: 380°C±5°C, Soldering time: 3sec+1/-0sec
- Numbers of soldering iron: Maximum twice as one time for 4 pads

9. Taping Specifications

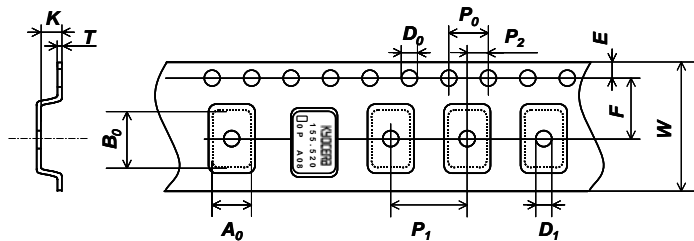

Unit: (mm)

Symbol	A_0	B_0	W	F	E
Dimensions	5.4±0.1	7.4±0.1	16.0±0.2	7.5±0.1	1.75±0.1
Symbol	P_1	P_2	P_0	D_0	T
Dimensions	8.0±0.1	2.0±0.1	4.0±0.1	1.5+0.1/-0	0.3±0.05
Symbol	K	D_1			
Dimensions	2.0±0.1	1.55±0.1			

Fig.5 Emboss Carrier Tape

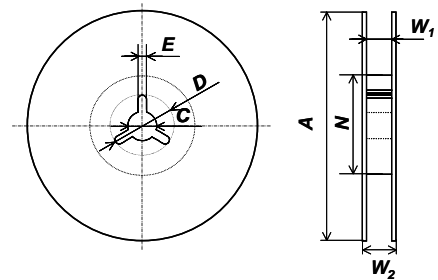

Unit: (mm)

Symbol	A	N	W_1
Dimensions	180 +0/-3	60+1/-0	17.0±0.2
Symbol	W_2	C	D
Dimensions	19.5±1.0	13.0±0.2	21.0±0.8
Symbol	E		
Dimensions	2.0±0.5		

Fig.6 Reel

9-1. Taping Quantities

- The taping of per reel shall be packed 1,000 pcs.
- The parts shall be contained continuously in the pocket.

9-2. Leader and Blank Pockets

- The package shall be consisted of leader, blank pockets and loaded pocket as follows "Fig. 8".
- The power of peeling strength between top tape and carrier tape shall be 0.1N(10gf) to 0.7N(70gf) as follows "Fig. 9".

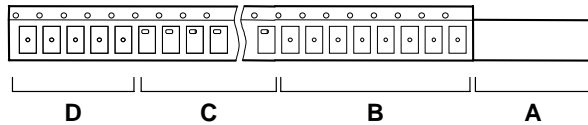

- A) Leader
- B) Blank Pocket (40mm to 320mm)
A+B: 500mm to 560mm
- C) Load Pocket
- D) Blank Pocket (40mm minimum)

Fig.7 Packing Method

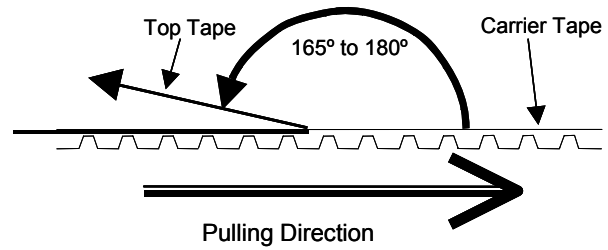

Fig.8 Peeling Strength

9-3. Reel Label

The reel label shall be consisted as below. (Based on EIAJ C-3 format)

- | | |
|-------------------------|------------------|
| A) Customer Part Number | D) Shipping Date |
| B) Lot No. | E) Vender Name |
| C) Quantities | |

9-4. Exterior Package Label

The oscillator shall be packed properly to avoid defect in transportation. The exterior package label shall be consisted as below.

- | | |
|-------------------------|------------------|
| A) Name of Customer | E) Quantities |
| B) P/O No. | F) Shipping Date |
| C) Customer Part Number | G) Vender Name |
| D) Lot No. | |

10. The agreement of this specifications

If the something suspicious is that part of the contents of this specification, it shall be resolved by mutual deliberations.

11. Remarks on Usages

A) Storage Conditions

The parts shall be stored in temperature range of -5 to +40°C, humidity 40 to 60% RH, and avoid direct sunlight. Then the parts shall be used within 6 months.

B) Handling Conditions

Although the part has protection circuit against static electricity, when excess static electricity is applied, the inside IC may get damaged.

Before mounting on the PCB, please make sure the direction of the part is correct. Otherwise the part of temperature will increase. And also the part will have some damages.

Please do not use the parts under the unfavorable condition such as beyond specified range in this specification.

Please do not use the parts under the condition, in the water or in the salt water also environment of dew or harmful gas.

C) Soldering Conditions

This product can respond to the general Pb-free reflow profile. The wave soldering can not be supported.

D) Washing Conditions

Ultra sonic cleaning is available. However there is a possibility that Crystal in the part may cause damaged under certain condition. Therefore please test before using.

After washing, please dry the parts completely. Otherwise water drops between the parts and PCB may cause migration.

In case of using this part without above precaution, Kyocera is unable to guarantee the specific characteristics.

