

REFERENCE

SPEC. No. ED-12G036A
ISSUE February 8, 2013

SHARP

SYSTEM DEVICE DIVISION
ELECTRONIC COMPONENTS AND DEVICES GROUP
SHARP CORPORATION

SPECIFICATION

DEVICE SPECIFICATION FOR

DISTANCE MEASUREMENT SENSOR
MODEL No.

GP2Y0E03

Specified for _____

Enclosed please find copies of the Specifications which consists of 20 pages including cover.
This specification sheets and attached sheets shall be both side copy.
After confirmation of the contents, please be sure to send back copies of the Specifications
with approving signature on each.

CUSTOMER'S APPROVAL

DATE _____

BY _____

PRESENTED

DATE Feb. 8, 2013

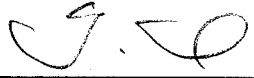
BY 

T. Ichinose,
Department General Manager of
Development Dept. III
System Device Division
Electronic Components and Devices Group
SHARP CORPORATION

Product name : Distance Measuring Sensor

Model No. : GP2Y0E03

1. These specification sheets include materials protected under copyright of Sharp Corporation ("Sharp"). Please do not reproduce or cause anyone to reproduce them without Sharp's consent.
2. When using this product, please observe the absolute maximum ratings and the instructions for use outlined in these specification sheets, as well as the precautions mentioned below. Sharp assumes no responsibility for any damage resulting from use of the product which does not comply with the absolute maximum ratings and the instructions included in these specification sheets, and the precautions mentioned below.

(Precautions)

(1) Please do verify the validity of this part after assembling it in customer's products, when customer wants to make catalogue and instruction manual based on the specification sheet of this part.

(2) This product is designed for use in the following application areas ;

- OA equipment Audio visual equipment · Home appliances
- Telecommunication equipment (Terminal) · Measuring equipment
- Tooling machines · Computers

If the use of the product in the above application areas is for equipment listed in paragraphs (3) or (4), please be sure to observe the precautions given in those respective paragraphs.

(3) Appropriate measures, such as fail-safe design and redundant design considering the safety design of the overall system and equipment, should be taken to ensure reliability and safety when this product is used for equipment which demands high reliability and safety in function and precision, such as ;

- Transportation control and safety equipment (aircraft, train, automobile etc.)
- Traffic signals · Gas leakage sensor breakers · Rescue and security equipment
- Other safety equipment

(4) Please do not use this product for equipment which require extremely high reliability and safety in function and precision, such as ;

- Space equipment · Telecommunication equipment (for trunk lines)
- Nuclear power control equipment · Medical equipment
- Power generation and power transmission control system (Key system)

(5) Please contact and consult with a Sharp sales representative if there are any questions regarding interpretation of the above four paragraphs.

3. Please contact and consult with a Sharp sales representative for any questions about this product.

1. Application

This specification applies to the outline and the characteristics of the distance measuring sensor: Model No. GP2Y0E03

2. Outline

Refer to the attached drawing No. CY15117i02, Page3

3. Ratings and characteristics

Refer to the attached sheet, Page 4.

4. Reliability

Refer to the attached sheet, Page7.

5. Outgoing inspection

Refer to the attached sheet, Page7.

6. Supplements

6-1 GP2Y0E03 Example of output distance characteristic

Refer to the attached sheet, page 8.

6-2 This product shall not contain the following materials.

Also, the following materials shall not be used in the production process for this product.

Materials for ODS : CFC_s, Halon, Carbon tetrachloride 1.1.1-Trichloroethane (Methyl chloroform)

6-3 Product mass : Approx. 0.85g (TYP)

6-4 Brominated flame retardants

Specific brominated flame retardants such as the PBB and PBDE are not used in this device at all.

6-5 Compliance with each regulation

6-5-1 The RoHS directive(2002/95/EC)

This product complies with the RoHS directive(2002/95/EC) .

Object substances: mercury, lead (except for lead in high melting temperature type solders and glass of electronic components), cadmium, hexavalent chromium, polybrominated biphenyls (PBB) and polybrominated diphenyl ethers (PBDE)

6-5-2 Content of six substances specified in Management Methods for Control of Pollution Caused by Electronic Information Products Regulation (Chinese : 电子信息产品污染控制管理办法).

Category	Toxic and hazardous substances					
	Lead (Pb)	Mercury (Hg)	Cadmium (Cd)	Hexavalent chromium (Cr ⁶⁺)	Polybrominated biphenyls (PBB)	Polybrominated diphenyl ethers (PBDE)
Distance measuring sensor	✓	✓	✓	✓	✓	✓

✓ : indicates that the content of the toxic and hazardous substance in all the homogeneous materials of the part is below the concentration limit requirement as described in SJ/T 11363-2006 standard .

7. Notes

Refer to the attached sheet, Page9.

8. Packing specification

Refer to the attached drawing No. CY15118i09, Page11.

9. Appendix

Refer to the attached sheet, Page12.

GP2Y0E03 (ED-12G036A)

2.Outline

(Drawing No. CY15117i02)

Scale : 5/1 Unit : mm

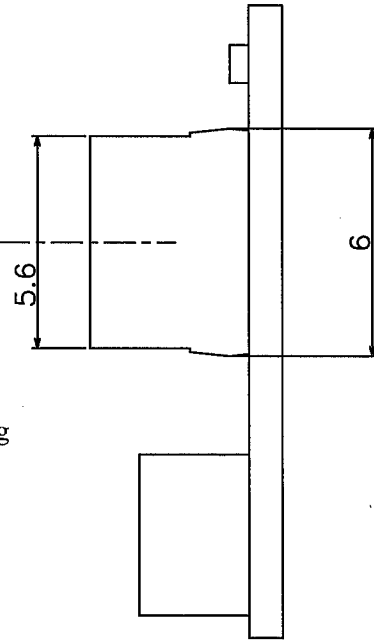
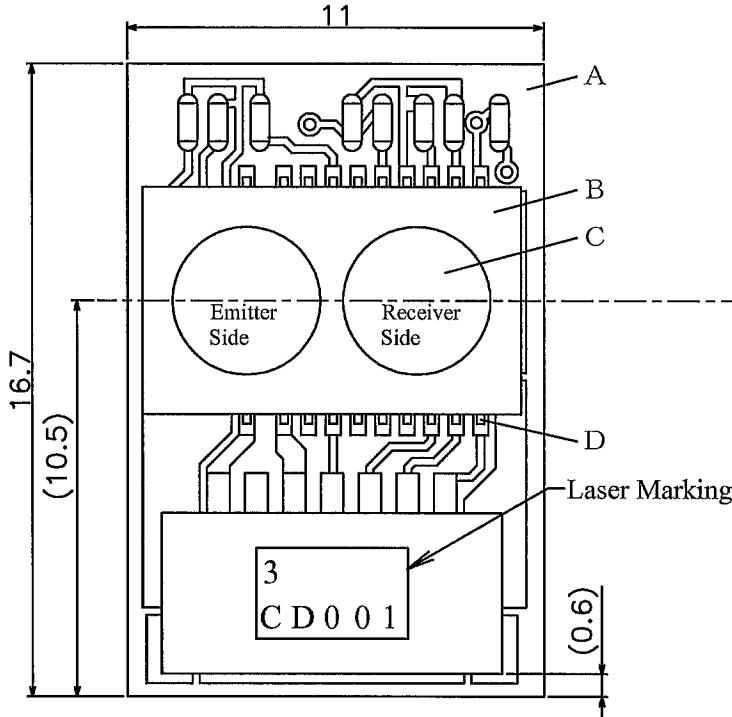

Connection Diagram

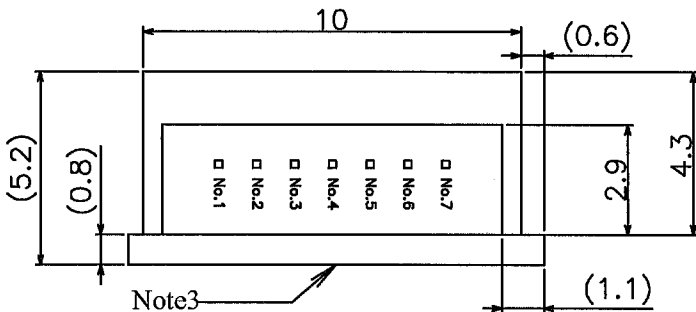

No	Symbol	Pin name
No1	VDD	Supply Voltage
No2	Vout(A)	Output Terminal
No3	GND	Ground
No4	VIN(IO)	I/O Supply Voltage
No5	GPIO1	Input Terminal for Active/Stand-by Control
No6	SCL	I2C Clock
No7	SDA	I2C Data Bus

- Note1: Unspecified tolerance shall be $\pm 0.2\text{mm}$
- Note2: The dimensions in parenthesis are shown for reference
- Note3: The PCB backside has some open pattern. Please do not short circuit of these pattern.

Laser Marking

$\overline{3}$ GP2Y0E03 (Model No)
 $\overline{CD001}$ Lot No.
 Month (1 to 9,O,N,D)
 (DIN standard symbol)
 Year (DIN standard symbol)
 DIN standard year production
 (Remove G,I,O,Q,Y,Z)
 (It repeats itself by a period for 20 years.)

Year	Symbol
2012	C
2013	D
...	...
2028	W
2029	X

Material

A	PCB	Glass Epoxy(UL94-V0)
B	Package	Black LCP(UL94-V0)
C	Lens	Epoxy Resin with visible-cut filter
D	Device Terminal	42ALLOY(Pd-Au plating)

•Connector

SM07B-SRKS-TB(HF)

•Housing Recommendation

SHR-07V-BK-B or

SHR-07V-S-B

(JST Mfg. Co., Ltd.)

3-1. Schematic

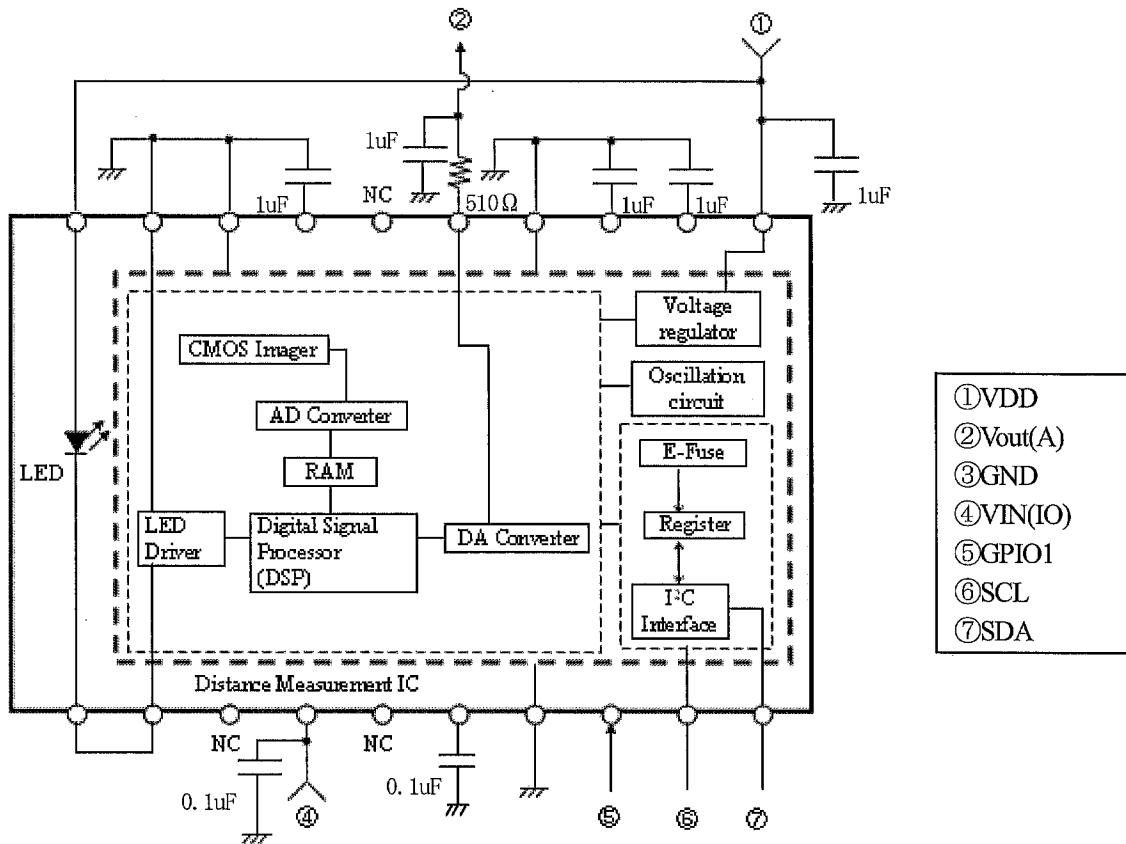

Please use an electric source with an output current of 150mA or more because LED pulse current is more than 100mA.

3-2. Absolute maximum ratings

Ta=25°C (unless otherwise specified)

Parameter	Symbol	Ratings	Unit	Remark
Supply voltage	VDD	-0.3 to +5.5	V	-
Output terminal voltage	Vout (A)	-0.3 to +2.8	V	-
Output current	Iout(A)	-6.0 to +6.0	mA	-
I/O supply voltage	VIN (IO)	-0.3 to VDD+0.3 (VDD ≤ 3.3V) -0.3 to +3.6 (VDD > 3.3V)	V	Refer to3-4
Input terminal voltage	GPIO1	-0.3 to VIN(IO)+0.3	V	Refer to3-4
I²C input terminal voltage	SCL	-0.3 to VIN(IO)+0.3	V	Refer to3-4
I²C I/O terminal voltage	SDA	-0.3 to VIN(IO)+0.3	V	Refer to3-4
Operating temperature	Topr	-10 to +60	°C	-
Storage temperature	Tstg	-40 to +70	°C	-

Recommended operating conditions

Parameter	Symbol	Rating	Unit	Remark
Supply voltage	VDD	2.7 to 5.5	V	-
I/O supply voltage	VIN (IO)	1.8 to 3.3	V	-
SCL, SDA High level input	VIH1	Min. VIN(IO) x 0.7	V	-
SCL, SDA Low level input	VIL1	Max. VIN(IO) x 0.3	V	-
GPIO1 High level input	VIH	Min. VIN(IO) x 0.7	V	Operating state
GPIO1 Low level input	VIL	Max. VIN(IO) x 0.3	V	Stand-by state

3-3. Electro-optical Characteristics

(Ta=25°C, VDD=3V)

Parameter	Symbol	Conditions	MIN.	TYP.	MAX.	Unit
Measuring distance range	L*	(Note 1, 2)	4	-	50	cm
Distance value	D1	L=50cm (Note 1, 2, 3)	45	50	55	cm
Distance value	D2	L=10cm (Note 1, 2, 3)	9	10	11	cm
Distance value	D3	L=4cm (Note 1, 2, 3)	3	4	5	cm
Output terminal voltage	Vout(A)1	L=50cm (Note 1, 2)	0.3	0.55	0.8	V
Output terminal voltage	Vout(A)2	L=10cm (Note 1, 2)	1.9	2.0	2.1	V
Output terminal voltage	Vout(A)3	L=4cm (Note 1, 2)	2.1	2.2	2.3	V
Average supply current	Icc1	L=50cm, GPIO1=VIN(IO)	-	26	36	mA
Stand-by supply current	Icc2	GPIO1=GND	-	20	60	μA
Response time (Note 4)	Ts	L=50cm → L=4cm (Note 5)	-	-	40	ms

* L: Distance to reflective object

(Note 1) Under dark condition

(Note 2) Using reflective object :

White paper (Made by Japan Color Research Institute order made color chart : mat, reflective ratio : 90%)

(Note 3) Distance data through I²C bus

(Note 4) Max. time means that it takes time to stabilize output due to the change of reflected signal light.

Definition : the case that object condition is changed suddenly from the least reflection(max. gain condition in internal circuit) to the most reflection (min. gain condition in internal circuit).

(Note 5) Method of measuring (Ts)

Connect GPIO1 with GND during measuring L=50cm with reflective object: Gray paper (mat, reflective ratio : 10%).

After changing the position (L=4cm with reflective object: White paper (mat, reflective ratio : 90%),

Measuring the time of the output terminal : Vout(A) until stabilizing after connecting GPIO1 with VIN(IO).

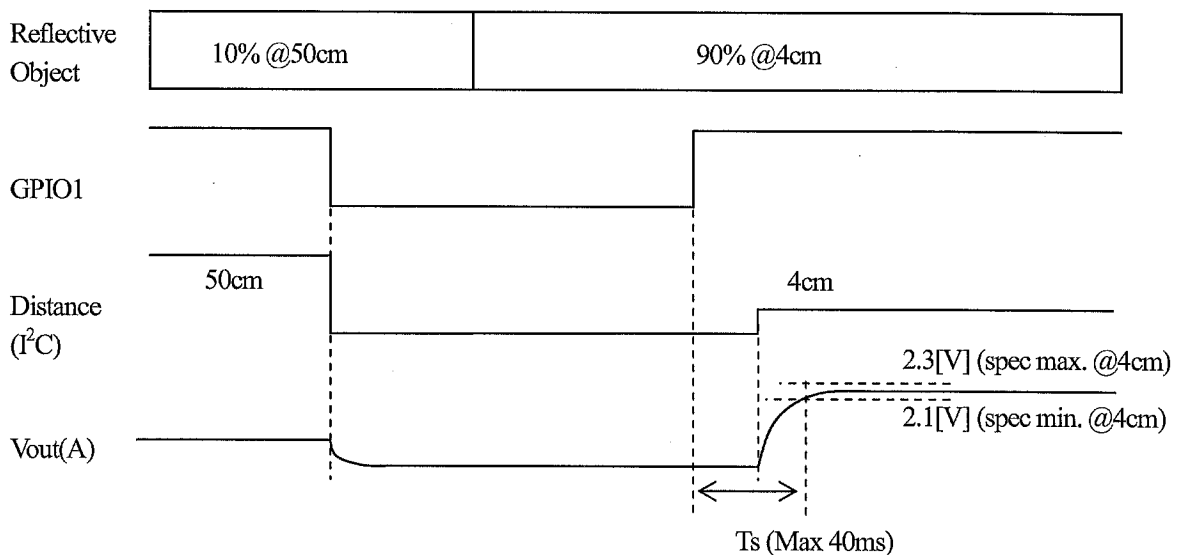

Response time of I²C output is faster than that of Vout(A) because it is stabilized soon after distance data output. Distance data is updated every 2ms after response time.



3-4. Timing Chart

3-4-1 Power On/Off Timing Sequence

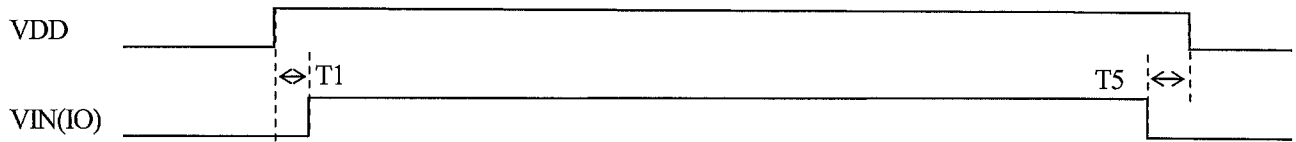

T1, T5 : Refer to 3-4-2

VIN(IO) should be turned off before VDD is turned off, or at the same time when VDD is turned off. I²C communication with other devices connected to the same bus is not allowed after VDD or VIN(IO) is turned off. In case that both of VDD and VIN(IO) turn off, GPIO1, SCL and SDA should be pull low. In case that only VIN(IO) turn off, GPIO1, SCL and SDA should be pull low. If this product is operated under the condition except the above, this product or other device around it may give damage due to excessive current.

3-4-2 Active / Stand-by timing sequence

There are two ways (Hardware / Software) to control Active/stand-by state.

HW : GPIO1 is set High or Low

GPIO1=high : Active state

GPIO1=Low : Stand-by state

SW : I²C register program (Refer to 9-1(5))

SW control is effective when GPIO1 is high.

(1) Controlled by GPIO1

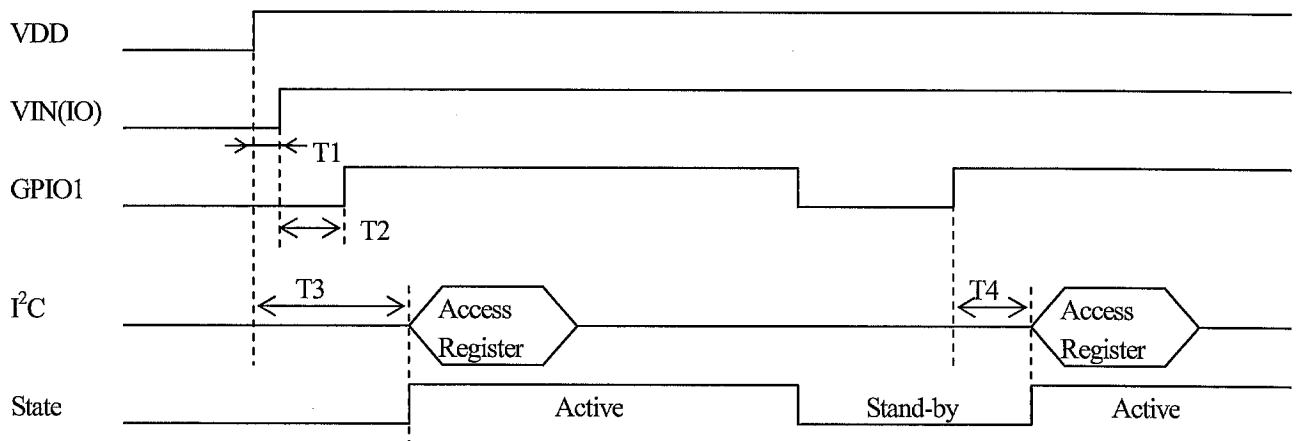

(2) Controlled by I²C

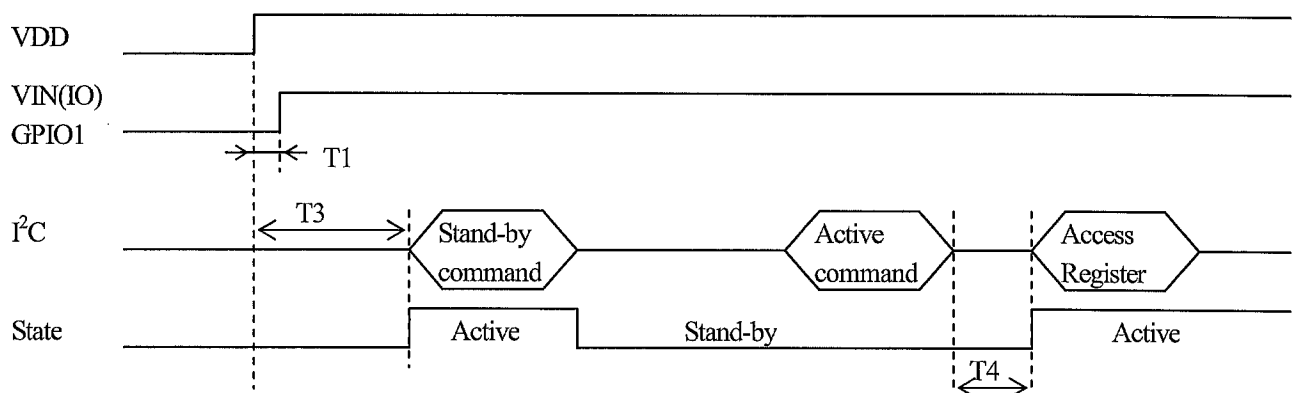

(Ta=25°C)

	Description	Min	Max	Unit
T1	IO power delay after VDD power on	0	5	ms
T2	GPIO1 delay after VIN(IO) power on	0	-	ms
T3	I2C access delay after VDD power on	5	-	ms
T4	I2C access delay after GPIO1 high or active command completed	500	-	us
T5	VIN(IO) leading to VDD power off	0	-	us

4. Reliability

The reliability of products shall be satisfied with items listed below.

Confidence level : 90%

LTPD : 20 or 30

No.	Test Items	Test Conditions	Failure Judgment Criteria	Samples (n) Defective (c)
1	Temperature cycling	1 cycle -40°C to +70°C (30min.) (30min.) 25 cycle test	Initial x 0.36 > Vout(A)1 Vout(A)1 > Initial x 1.64 or Initial x 0.8 > D1 D1 > Initial x 1.2 (Note 1)	n=11, c=0
2	High temp. and high humidity storage	+40°C, 90%RH, 500h		n=11, c=0
3	High temp. storage	+70°C, 500h		n=11, c=0
4	Low temp. storage	-40°C, 500h		n=11, c=0
5	Operation life (High temp.)	+60°C, VDD=3V, 500h		n=11, c=0
6	Mechanical shock	1000m/s ² , 6.0ms 3times/±X, ±Y, ±Z direction		n=8, c=0
7	Variable frequency vibration	10 to 55 to 10Hz/1min. 2h/X, Y, Z direction overall amplitude : 1.5mm		n=8, c=0

(Note 1) Test conditions are according to 3-3 Electro-optical characteristics.

(Note 2) After test, measurement shall be measured after leaving under the normal temperature and the normal humidity for two hours. But no dew point.

5. Outgoing inspection

(1) Inspection lot

Inspection shall be carried out per each delivery lot.

(2) Inspection method

A single sampling plan, normal inspection level II based on ISO 2859 is applied.

The AQL according to the inspection items are shown below.

Defect	Inspection item	AQL (%)
Major defect	Electro-optical characteristics defect (In para. 3-3)	0.4
Minor defect	Defect on appearance and dimension ※ Crack, chip, scratch, stain	1.0

※ Crack, chip, scratch, stain

One which affects the characteristics of para. 3-3 shall be defect.

6. Supplements

6-1 Example of output distance characteristics

Example of output distance characteristics of GP2Y0E03

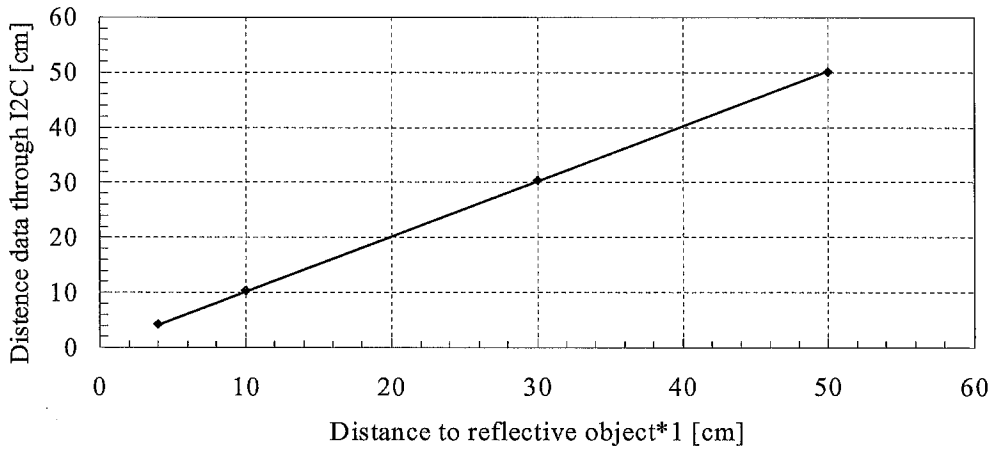

Example of output distance characteristics of GP2Y0E03

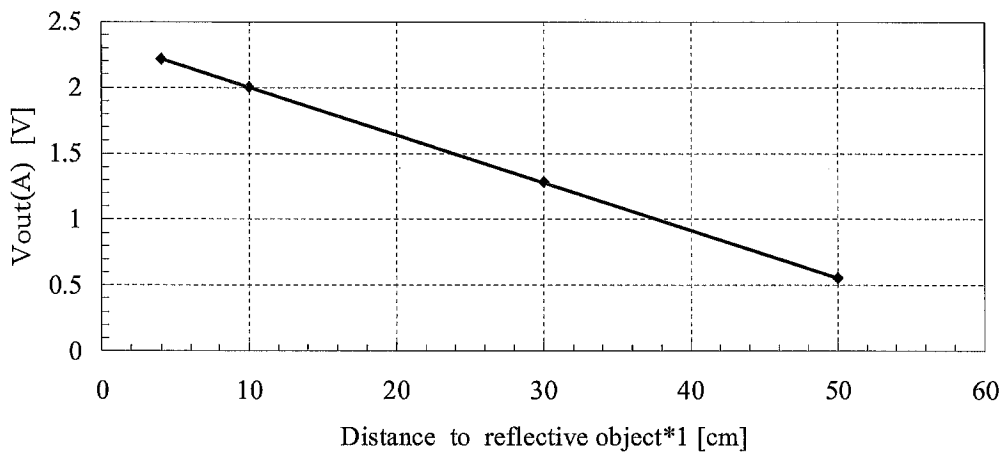

*1 : Using reflective object : White paper (reflective ratio : 90%)

6-2 Example of directional angle of emitting beam

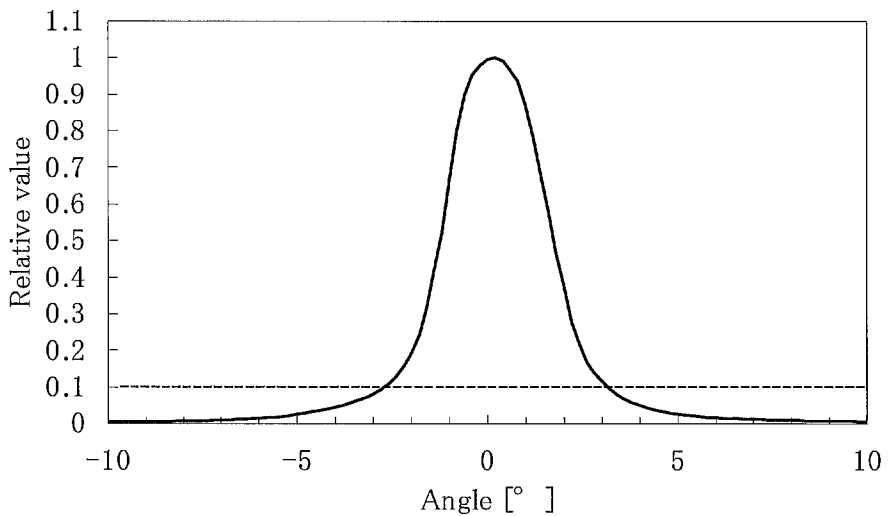

7. Notes

[Advice for the optics]

- 7-1 Lens of this device shall be kept cleanly. There are cases that dust, water or oil and so on deteriorate the characteristics of this device. Please consider in actual application.
- 7-2 In case that protection cover is set in front of this sensor, the protection cover shall be recommended to use material which doesn't scatter light and be matt finish. And the protection cover which has the most efficient transmittance at the emitting wavelength range of LED for this product ($\lambda=850\text{nm}\pm 70\text{nm}$). And this protection cover is recommend to be flat. And this protection cover shall be recommended to be parallel to the emitter and detector portion. In case that protection cover is set in front of this sensor, It emits reflected light from this protection cover. If this reflect light reaches in detector portion, the output distance of this product may be changed. The output distance characteristics of this product may be changed with according to material (①) or transmittance (②) or the thickness (③) or the distance between the protection cover and this product (④) or the angle between surface and back (⑤) or the angle between this cover and this sensor(⑥). In case that protection cover is set, please design to consider that this reflective light is minimized. And it shall be effective to put light shield wall between emitting lens and receiving lens as shown in below.

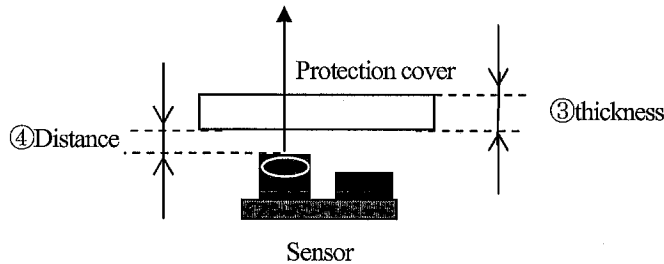

Condition	③thickness	④distance	light shield wall
No1	1mm	0mm	—
No2	1mm	1mm	nonexistence
No3	2mm	0mm	—
No4	2mm	1mm	existence 【*】

Direct reflective light becomes large as Distance from sensor to protection cover and thickness of this cover become large. In case thickness is 2mm and distance is 1mm, measuring distance is changed shift larger from actual distance than other condition. It shifts can make small by using installation of light shield 【*】 and compensation function 【**】 .

【*】 Noted for installation of light shield

Inner distance between lens of detector and lens of emitter is around 0.6mm (reference). So the width of light shield is recommended to be less than 0.6mm. In case the width of light shield is longer than inner distance, measuring distance is changed by Shield a part of emitter lens or detector lens. Please confirm that there is no problem under the actual equipment. And In case between protection cover and light shield or between light shield and this sensor exists space, The effect of light shield is small because light from emitter leaks. The light shield wall is recommended to use the material that have the low transmittance at the emitting wavelength range of LED for this product ($\lambda=850\text{nm}\pm 70\text{nm}$). When the material of light shield wall is hard, and the power stress in which it is added to this product is large, measuring distance may shift from actual distance

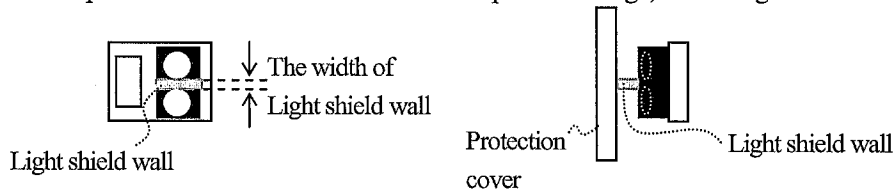

【**】 Noted of compensation function

This product has the function which rectifies error shift by the direct reflective light from protection cover. The accuracy after compensation is based on a protection cover or its installation condition. This function can be active when it set correction factor in this product by I2C or E-fuse (refer to 9-2). Please refer to application manual about the detail of this function. Neither installation of a light shield wall nor use of a compensation function guarantees the distance characteristic. These improve error shift of the distance characteristic.

Regardless of use of a light shield wall or a compensation function, please use it after confirming with customer's product.

[Advice for the characteristics]

- 7-3 In case that there is an object near to light exits of the sensor between the sensor and the detected object, please use this device after confirming sufficiently what the characteristics of this sensor do not change by the object.
- 7-4 This product has the function to remove disturbance light by the cancellation function of ambient light, a visible light cut lens, etc. But when the detector receive direct light from the sun, tungsten lamp and so on, there are cases that it can not measure the distance exactly. Please consider the design that the detector does not receive direct light from such light source. When you operate the customer's set installing this product by the remote control, please consider soft that the output of this product being disregarded at the time of remote control operation by software.
- 7-5 Distance between sensor and mirror reflector cannot be measured exactly.
- 7-6 In case that reflective object has boundary line clearly, there is cases that distance can not measure exactly. At that time, if direction of boundary line and the line between emitter center and detector center are parallels, it is possible to decrease deviation of measuring distance.

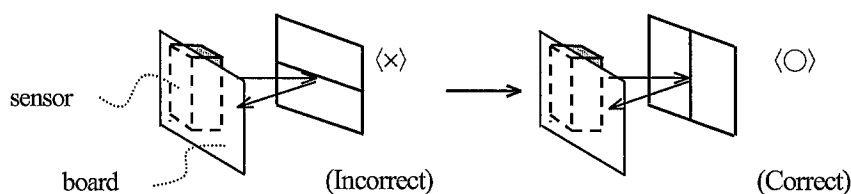

- 7-7 In order to decrease measuring error due to moving direction of object, we recommend to mount the sensor like below drawing.

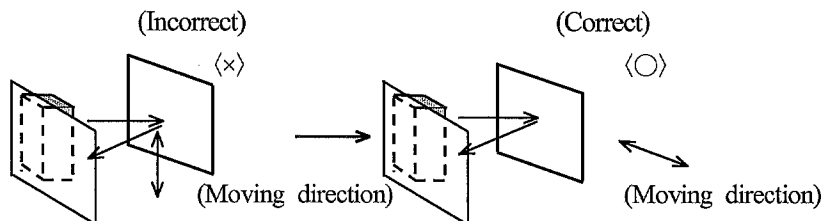

- 7-8 For satisfying the specification of the electro optical characteristic in 3-3, it is necessary to install a flat surface of object in vertical of emitted light, and it is necessary to reflect the whole emitted light as shown in the following figure. As shown in the 6-2 (example of directional angle of emitting beam), The angle is around $6^\circ (\pm 3^\circ)$ where emission becomes 10% of peaks. The object needs to exist in whole around 10 degrees (± 5 degrees) area including the variation of peak position. For example, when the object is in 50 cm, it is necessary to install the object of at least 9cm diameter parallel to the surface of this sensor as follows. However above example doesn't guarantee specification, please use it after confirming with customer's product.

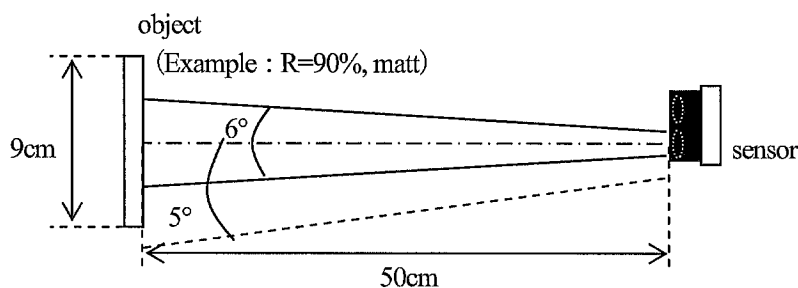

[Notes on handling]

- 7-9 Please don't do washing. Washing may deteriorate the characteristics of optical system and so on.
Please confirm resistance to chemicals under the actual usage since this product has not been designed against washing.
- 7-10 Please use this product under the condition that applied stress to the connector below 0.49N. And, harness is pulled in the state where it attached this sensor, or please be careful so that the stress more than the above may not be added to this sensor.
- 7-11 This product have the parts that mount to the substrate by soldering . Since there is a possibility that a solder mounting part may break when this product is used, the stress more than 4.9N should not be added to this product.

8. Packing specification

(Drawing No. CY15118i09)

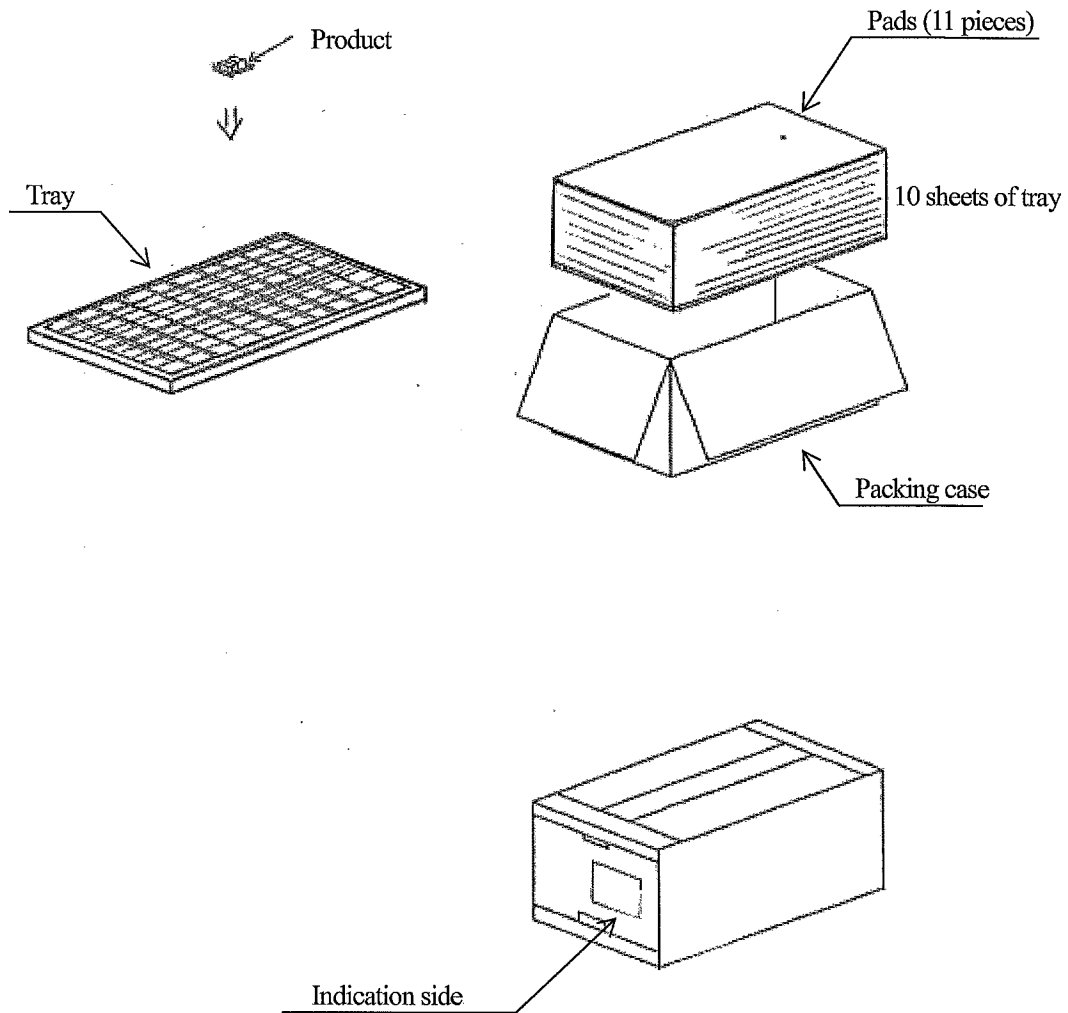

- (1) Packing number
Max 100 pieces per tray
Max 1000 pieces per case
- (2) Close the lid of case and seals with craft tape, and fill in the blanks of Model No., quantity and date.
- (3) Outside : 264 x 203 x 105 (mm)
- (4) Indication
The content of the indication conforms to EIAJ C-3 and the following items are indicated.
Model No., Internal production control name, Quantity, Packing date, Corporate name, Country of origin



9. Appendix

9-1 I²C interface

This product has 7 bits slave address which comply with I²C bus standard (max 400kHz), so a measured distance value can be read through I²C bus. Besides, this product can change register value for each function through I²C bus.

The below table shows I²C bus terminal.

Pin name	Description
SCL	I ² C clock
SDA	I ² C data bus

(1) I²C data transfer format

Symbols explaining read and write format of this product are shown in the following table.

Symbol	Description	Note
S	Start	Master output
A	ACK	Slave output
NA	NACK	Master output
P	Stop	Master output
Sub Add	Register address	Master output
Data	Data	Master / Slave output

(2) Write format

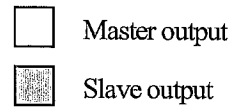
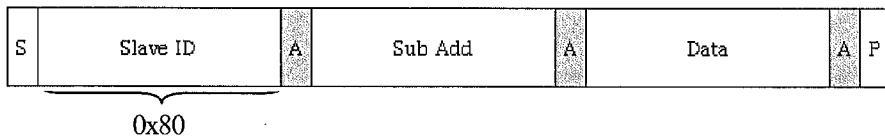

1. Master generates start condition.
2. Master places 1st byte data that include slave address (7bit) with a read/write control bit.
3. Slave issues acknowledgment.
4. Master places 2nd byte address data on SDA.
5. Slave issues acknowledgment.
6. Master places 8 bits data on SDA.
7. Slave issues acknowledgement.
8. Master generates a stop condition to end this write cycle.

(3) Read format

(1st-cycle)

(2nd-cycle)

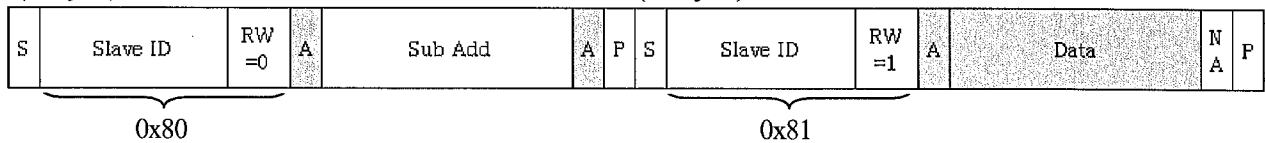

1st cycle

1. Master generates a start condition.
2. Master places 1st byte data that are combined slave address (7bits) with a read/write control bit (R/W=0) to SDA.
3. Slave issues acknowledgement.
4. Master places 2nd byte address data on SDA.
5. Slave issues acknowledgement.
6. Master generates a stop condition to end 1st cycle.

2nd cycle

7. Master generates a start condition.
8. Master places 1st byte data that are combined slave address (7bits) with a read/write control bit (R/W=1) to SDA.
9. Slave issues acknowledgement.
10. 8 bits data is read from internal control register of this product which address was assigned by 1st cycle.
11. Master generates negative acknowledgement.
12. Master generates a stop condition to end this read cycle.



This product supports the continuation read-out function (Burst-Read), So it can read register value from specified address (8.) by ACK that Master transmits (11.). When read-out of data is stopped, Master transmits NACK. Since it don't need to specify address, it is possible to shorten time reading register value. Also Since this product supports Repeat-Start function, it be able to skip (6). process. Since I²C bus is not opened between 1st cycle and 2nd cycle by skipping (6). , cross talk can be prevented also when two or more Master(s) exist on the same bus.

This product supports burst-read and repeat start. Below shows these format.

•burst read without repeat start

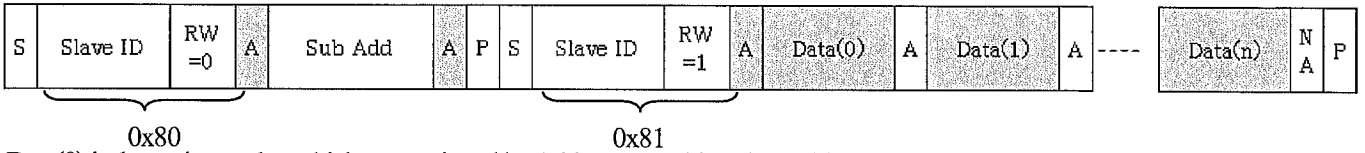

Data(0) is the register value which was assigned by Address. Data(1) and Data(2) are the register value of Address+1 and Address+2, respectively.

•burst read with repeat start

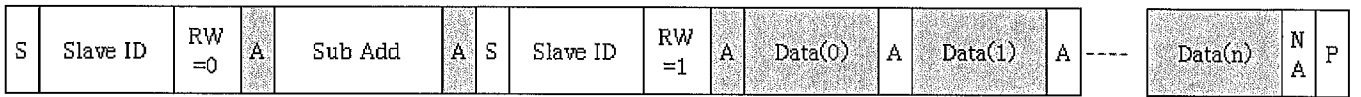

(4) Read out measured distance value and calculation

Register name	Add	Data	Note
Distance[11:4]	0x5E	Data1	Upper Data
Distance[3:0]	0x5F	Data2	Lower Data
Shift Bit[2:0]	0x35	Data3	Coefficient n

Read step

- ① Read the value of Add:0x5E and Add:0x5F with burst read.
- ② Read the value of Add:0x35 (Data3=n)
- ③ Measure distance value = Distance[11:0]/16/(2^n) [cm]

Both Distance[11:4] and Distance[3:0] is 8 bits data. 12 bits data of the above Distance[11:0] must be composed of jointing 8 bits data of distance[11:4] and the last 4 bits data of distance[3:0] as shown in the below.

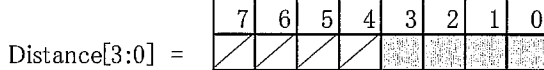
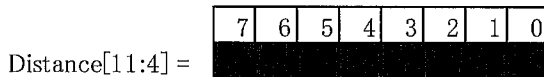
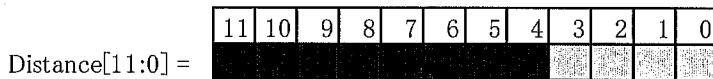

(5) Active / Stand-by control

This product can control operation mode and stand-by mode by I²C write command.

GPIO1 need to be kept "High level" to control active/stand-by condition by SW.

Register name	Add	data	condition
SW suspend [0]	0xE8	0x00	Active
		0x01	Stand-by

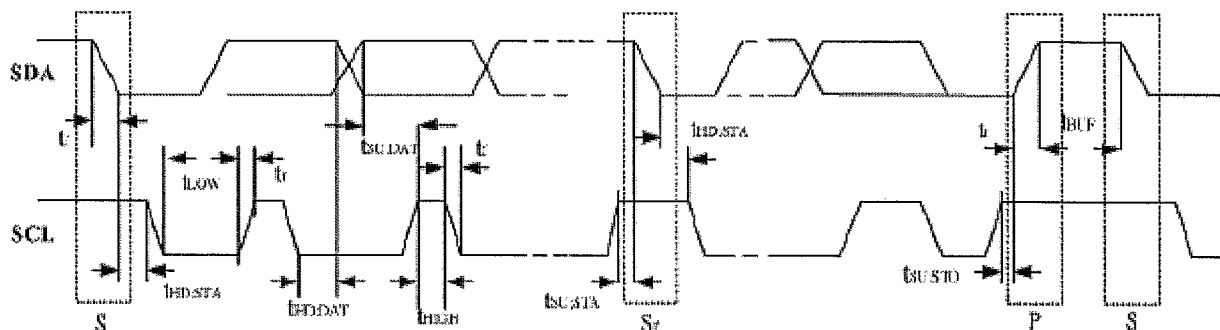
(6) I²C bus timing

(Ta = 25°C)

Parameter	Symbol	Min.	Max.	Unit
SCL clock frequency	f_{scl}	-	400	kHz
Hold time for Start/Repeat Start. After this period, the first clock pulse is generated.	$t_{HD:STA}$	0.6	-	us
Set-up time for a repeated start.	$t_{SU:STA}$	0.6	-	us
Low period of SCL clock.	t_{LOW}	1.3	-	us
High period of SCL clock	t_{HIGH}	0.6	-	us
Data hold time. For I ² C TM -bus device.	$t_{HD:DAT}$	-	0.9	us
Data set-up time.	$t_{SU:DAT}$	100	-	ns
Rise time of both SDA and SCL signals.	t_r	-	300	ns
Fall time of both SDA and SCL signals.	t_f	-	300	ns
Set-up time for STOP condition.	$t_{SU:STO}$	0.6	-	us
Bus free time between a STOP and START.	t_{BUF}	1.3	-	us
Capacitive load for each bus line.	C_b	-	150	pF
Noise margin at LOW level for each connected device.	V_{nL}	0.1VDD	-	V
Noise margin at HIGH level for each connected device.	V_{nH}	0.2VDD	-	V

(7) I²C DC timing characteristic

(Ta = 25°C)

Parameter	Symbol	Standard Mode		Fast Mode		Unit
		Min.	Max.	Min.	Max.	
Low level input voltage	V_{IL}	-0.3	0.3VIN(IO)	-0.3	0.3VIN(IO)	V
High level input voltage	V_{IH}	0.7VIN(IO)	VIN(IO)+0.3 3.9	0.7VIN(IO)	VIN(IO)+0.3 3.9	V V
Hysteresis of Schmitt trigger inputs VIN(IO) > 2V VIN(IO) < 2V	V_{hys}	-	-	0.05VIN(IO)	-	V
		-	-	0.1VIN(IO)	-	V
Low level output voltage (open drain of open collector) at 3mA sink current VIN(IO) > 2V VIN(IO) < 2V	V_{OL}	0	0.4	0	0.4	V
		-	-	0	0.2VIN(IO)	V
Output fall time from VIHmin to VILmax with a bus capacitance from 10pF to 400pF	T_{OF}	-	250	-	250	ns
Pulse width of spikes which must be suppressed by the input filter	t_{SP}	-	-	0	50	ns
Input current each I/O pin with an input voltage between 0.1VIN(IO) and 0.9VIN(IO)max	I_I	-10	10	-10	10	uA

9-2 E-Fuse Programming

(1) Summary

E-Fuse is a nonvolatile memory which is possible to write program only one time. So it is able to change some settings of this sensor by E-Fuse programming. Also compensation function can be active by E-Fuse programming. In case power supply of this sensor is OFF, this sensor keeps some programs that is written in E-Fuse. So when power supply is ON again, this sensor operates under the programmed condition as before.

Below is the basic set-up to program data in E-Fuse.

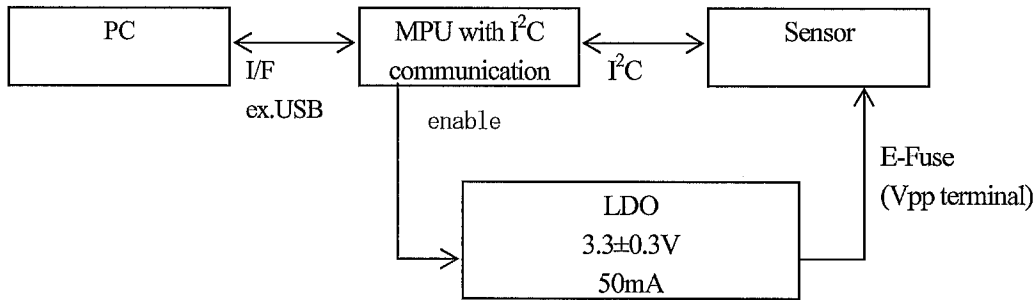

PC is used when different data is programmed to each sensor. It is unnecessary when same data which was set in MPU is programmed. Vpp terminal is on the back side of this sensor as shown in below figure.

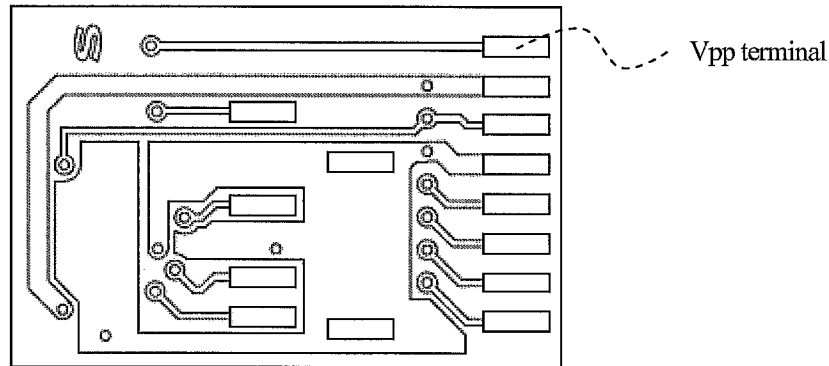

(2) Electric spec.

•Power Requirement

Vpp	Min.	Typ.	Max.	Unit
Voltage	3.0	3.3	3.6	V
Current	50	—	—	mA

•Power Timing

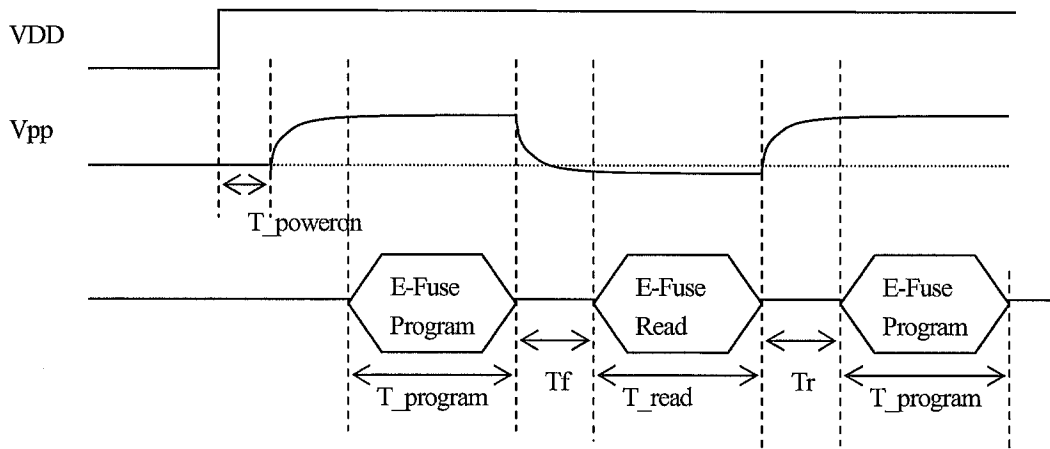

- T_{poweron} : E-Fuse power should be turn on 1ms later than VDD is applied.
- T_f : E-Fuse power regulator falling time.
- T_{program} : Program time depends on how many bits are programmed.
- T_{read} : Read time depends on how many bits are read.
- T_r : E-Fuse power regulator rising time.

(3) Program Flow

E-Fuse program through I2C is byte base (8bits can be programmed at one programming cycle), if more than 8bits need to be programmed, two or more cycles are necessary. Below is program flow chart.

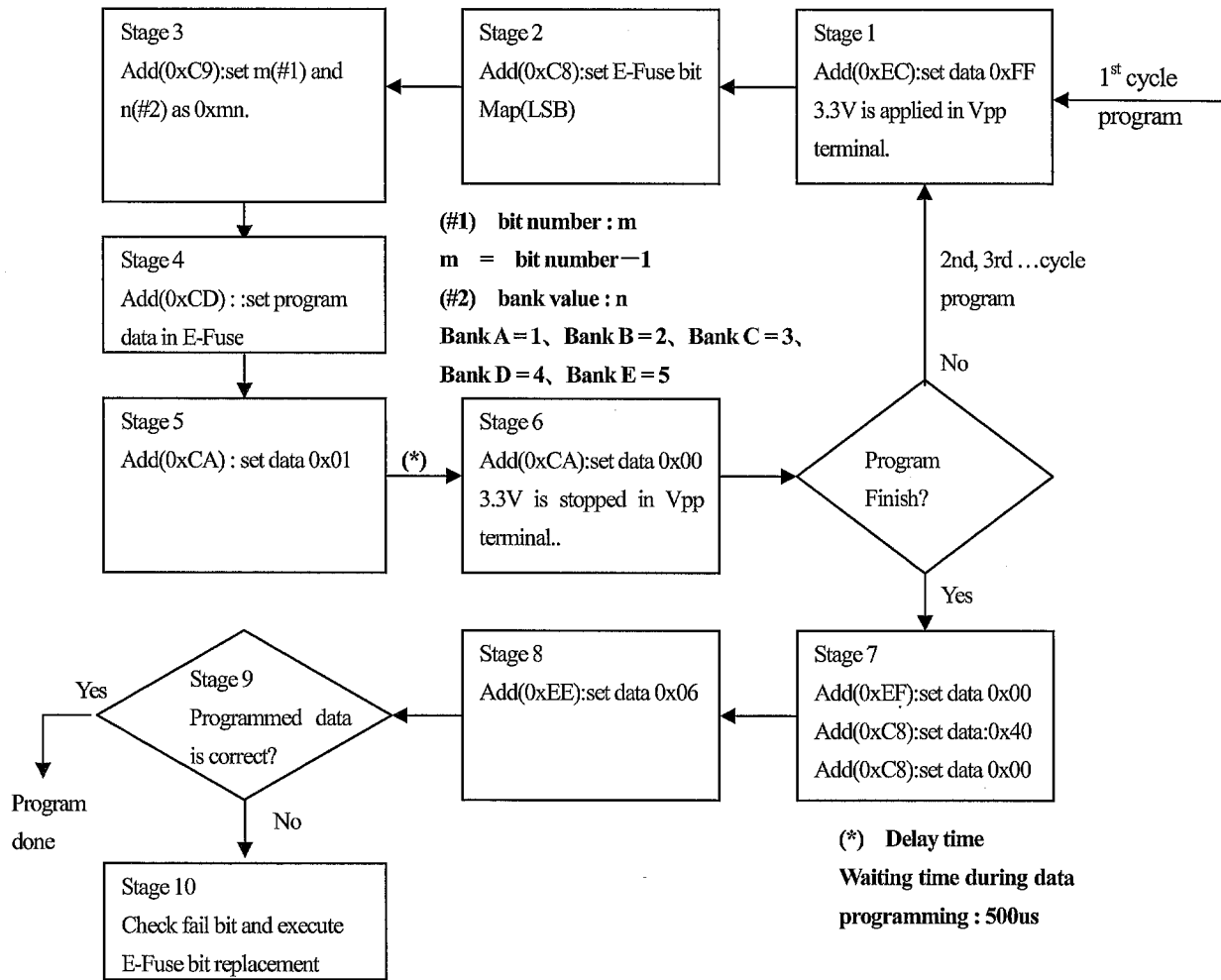

(4) E-Fuse bit map

There are 5 blocks (Bank A, Bank B, Bank C, Bank D and Bank E) in this sensor. Each block has 64bits. Initial value of each bit is 1. I2C slave address can be changed by programming 0 in designated bit Below shows E-Fuse bit map.

- Bank A (Bank value : n=1)
Not use.
- Bank B (Bank value : n=2)
Not use.
- Bank C (Bank value : n=3)
Not use.

• Bank D (Bank value : n=4)

Bit Map	D[0]	D[1]	D[2]	D[3]	D[4]	D[5]	D[6]	D[7]	D[8]	D[9]	D[10]	D[11]	D[12]	D[13]	D[14]	D[15]
item	x	x	x	x	x	x	x	x	x	x	x	x	x	x	x	x
Mapped Reg	not use								not use							
Bit Map	D[16]	D[17]	D[18]	D[19]	D[20]	D[21]	D[22]	D[23]	D[24]	D[25]	D[26]	D[27]	D[28]	D[29]	D[30]	D[31]
item	x	x	x	x	x	x	x	x	x	x	x	x	x	x	x	x
Mapped Reg	not use								not use							
Bit Map	D[32]	D[33]	D[34]	D[35]	D[36]	D[37]	D[38]	D[39]	D[40]	D[41]	D[42]	D[43]	D[44]	D[45]	D[46]	D[47]
item	x	x	x	x	x	x	x	x	x	x	x	x	x	x	x	x
Mapped Reg	not use								not use							
Bit Map	D[48]	D[49]	D[50]	D[51]	D[52]	D[53]	D[54]	D[55]	D[56]	D[57]	D[58]	D[59]	D[60]	D[61]	D[62]	D[63]
item	x	x	x	x	x	x	x		E-Fuse replacement							
Mapped Reg	0x19								0x18							

• Bank E (Bank value : n=5)

Bit Map	E[0]	E[1]	E[2]	E[3]	E[4]	E[5]	E[6]	E[7]	E[8]	E[9]	E[10]	E[11]	E[12]	E[13]	E[14]	E[15]
item	I ² C Slave ID					x	x	x	x	x	x	x	x	x	x	x
Mapped Reg	0x27								not use							
Bit Map	E[16]	E[17]	E[18]	E[19]	E[20]	E[21]	E[22]	E[23]	E[24]	E[25]	E[26]	E[27]	E[28]	E[29]	E[30]	E[31]
item	x	x	x	x	x	x	x	x	x	x	x	x	x	x	x	x
Mapped Reg	not use								not use							
Bit Map	E[32]	E[33]	E[34]	E[35]	E[36]	E[37]	E[38]	E[39]	E[40]	E[41]	E[42]	E[43]	E[44]	E[45]	E[46]	E[47]
item	x	x	x	x	x	x	x	x	x	x	x	x	x	x	x	x
Mapped Reg	not use								not use							
Bit Map	E[48]	E[49]	E[50]	E[51]	E[52]	E[53]	E[54]	E[55]	E[56]	E[57]	E[58]	E[59]	E[60]	E[61]	E[62]	E[63]
item	x	x	x	x	x	x	x	x	x	x	x	x	x	x	x	x
Mapped Reg	not use								not use							

×: not use

(5) Example of E-Fuse Programming

I²C Slave Address

This product operates on I2C bus as slave device. This product has 16 kinds of address by programming upper 4 bits of slave address. Bank E is used in order to change slave address. E[3:0] is the bit for address assignment, and E[4] is an enable bit. Changed E[3:0] turns effective after E[4] is programmed to be 0.

A7	A6	A5	A4	A3	A2	A1	A0	Slave ID		notes
E[3]	E[2]	E[1]	E[0]	×	×	×	R/W	Write	Read	
0	0	0	0	0	0	0	※	0x00	0x01	
0	0	0	1	0	0	0	※	0x10	0x11	
0	0	1	0	0	0	0	※	0x20	0x21	
0	0	1	1	0	0	0	※	0x30	0x31	
0	1	0	0	0	0	0	※	0x40	0x41	
0	1	0	1	0	0	0	※	0x50	0x51	
0	1	1	0	0	0	0	※	0x60	0x61	
0	1	1	1	0	0	0	※	0x70	0x71	
1	0	0	0	0	0	0	※	0x80	0x81	Default
1	0	0	1	0	0	0	※	0x90	0x91	
1	0	1	0	0	0	0	※	0xA0	0xA1	
1	0	1	1	0	0	0	※	0xB0	0xB1	
1	1	0	0	0	0	0	※	0xC0	0xC1	
1	1	0	1	0	0	0	※	0xD0	0xD1	
1	1	1	0	0	0	0	※	0xE0	0xE1	
1	1	1	1	0	0	0	※	0xF0	0xF1	

※R/W Write : 0、Read : 1

Stage1

Please refer to flow chart in 9-2(3)

Stage2

Data 0x00 is set in Address 0xC8 because LSB of bit map is 0 (=E[0]).

Stage3

Data 0x45 is set in Address 0xC9 because programming bit number is 5(=E[4:0]) and bank value is 5(=Bank E).

Note) Data is defined as 0xmn, where m=bit number - 1 and n = bank value.

Stage4

Data 0x00 is set in Address 0xCD in case that Slave ID(write) is set to 0x00.

Data 0x10 is set in Address 0xCD in case that Slave ID(write) is set to 0x01.

Stage5 ~ Stage8

Please refer to flow chart in 9-2(3).

Stage9

Programmed data in E-Fuse is checked whether it is correct or not by the following step.

step	Address	Data	R/W	Remark
1	0xEF	0x00	W	
2	0xEC	0xFF	W	
3	0xC8	0x40	W	
4	0xC8	0x00	W	
5	0xEF	0x03	W	
6	0x27	-	R	Check 0x27[4:0] = E[4:0] ?
7	0xEF	0x00		
8	0xEC	0x7F		

E-Fuse programming is done when 0x27[4:0] is equal to E[4:0]. If 0x27[4:0] is not equal to E[4:0], E-Fuse bit replacement should be executed because programming error occurs. (Refer to 9-2(6) E-Fuse bit replacement)

(6) E-Fuse Bit Replacement

There is the possibility that E-Fuse bit programmed fail (Fail rate is 20ppm/bit). Default value of each bit of E-Fuse is all "1", specified bit can be changed to "0" by executing program flow of 9-2(3). If the bit cannot be programmed to "0" (always "1"), then this bit is fail bit. This product has the function that fail bit can be replaced. The bit number which can be replaced is one. If 2bit are fail in this product, then this cannot be used.

E-Fuse bit replacement is executed by specifying replace bit in D[63:55] of E-Fuse bit map. LSB of Bank A is "0", and MSB of Bank E is "319". Fail bit can be shown as 9bit number, the number is programmed in D[63:55] to replace it.

• The case of A[1] replacement

Programmed value in D[63:55] is "1". (= 1+64*0 = 0x0001, where 0 is the bank value of bank A)

• The case of C[51] replacement

Programmed value in D[63:55] is "179". (= 51+64*2 = 0x00B3, where 2 is the bank value of bank C)

• The case of E[4] replacement

Programmed value in D[63:55] is "260". (= 4+64*4 = 0x0104, where 4 is the bank value of bank E)

(7) Example of E-Fuse Bit Replacement

The case where slave address is changed to 0x10(write) and 0x11(read) is shown in below concretely.

Stage1 Data=0xFF is set in Address=0xEC.

3.3V is applied in the Vpp terminal.

Stage2 Data=0x00 is set in Address=0xC8.

Stage3 Data=0x55 is set in Address=0xC9.

Stage4 Data=0x01 is set in Address=0xCD.

Stage5 Data=0x01 is set in Address=0xCA.

Wait for 500us.

Stage6 Data=0x00 is set in Address=0xCA.
Vpp terminal is grounded.

Stage1' Data=0xFF is set in Address=0xEC.
3.3V is applied in the Vpp terminal.

Stage2' Data=0x04 is set in Address=0xC8.

Stage3' Data=0x15 is set in Address=0xC9.

Stage4' Data=0x00 is set in Address=0xCD.

Stage5' Data=0x01 is set in Address=0xCA.
Wait for 500us.

Stage6' Data=0x00 is set in Address=0xCA.
Vpp terminal is grounded.

Stage7 Data=0x00 is set in Address=0xEF.
Data=0x40 is set in Address=0xC8.
Data=0x00 is set in Address=0xC8.

Stage8 Data=0x06 is set in Address=0xEE.

Stage9 Data=0xFF is set in Address=0xEC.
Data=0x40 is set in Address=0xC8.
Data=0x00 is set in Address=0xC8.
Data=0x03 is set in Address=0xEF.
Read out the data in Address=0x20.

When lower 5bits data[4:0] is 00001, E-Fuse program is finished.

When lower 5bits data[4:0] is not 00001, go to stage10(bit replacement).

Stage10 The case where the lower 5bits data is 10001 is assumed, and is shown in below flow. When E[4] is replaced, Data=0x04 is programmed in D[62:55] in 1st cycle and Data=0x01 is programmed in D[63] in 2nd cycle because programmed value is 260(=0x0104).

Stage10-1 Data=0xFF is set in Address=0xEC.
3.3V is applied in Vpp terminal.

Stage10-2 Data=0x37 is set in Address=0xC8.

Stage10-3 Data=0x74 is set in Address=0xC9.

Stage10-4 Data=0x04 is set in Address=0xCD.

Stage10-5 Data=0x01 is set in Address=0xCA.
Wait for 500us.

Stage10-6 Data=0x00 is set in Address=0xCA.
Vpp terminal is grounded.

Stage10-1' Data=0xFF is set in Address=0xEC.
3.3V is applied in Vpp terminal.

Stage10-2' Data=0x3F is set in Address=0xC8.

Stage10-3' Data=0x04 is set in Address=0xC9.

Stage10-4' Data=0x01 is set in Address=0xCD.

Stage10-5' Data=0x01 is set in Address=0xCA.
Wait for 500us.

Stage10-6' Data=0x00 is set in Address=0xCA.
Vpp terminal is grounded.

Stage10-7 Data=0x00 is set in Address=0xEF.
Data=0x40 is set in Address=0xC8.

Data=0x00 is set in Address=0xC8.

Stage10-8 Data=0x06 is set in Address=0xEE.

Stage10-9 Data=0xFF is set in Address=0xEC.

Data=0x40 is set in Address=0xC8.

Data=0x00 is set in Address=0xC8.

Data=0x03 is set in Address=0xEF.

Read out the data in Address=0x18 and Address=0x19.

When Data=0x04 in the Address of 0x18 and Data=0x01 in the address of 0x19, program is finished.

When Data \neq 0x04 in the Address of 0x18 and Data \neq 0x19[0]=1, it is not possible to correct (=NG).