

## Features

- Low gate charge
- 100% avalanche tested
- Improved dv/dt capability
- RoHS compliant
- Halogen free package
- JEDEC Qualification

$$V_{DSS} = 990 \text{ V @ } T_{jmax}$$

$$I_D = 7 \text{ A}$$

$$R_{DS(ON)} = 1.9 \Omega(\text{max}) @ V_{GS} = 10 \text{ V}$$

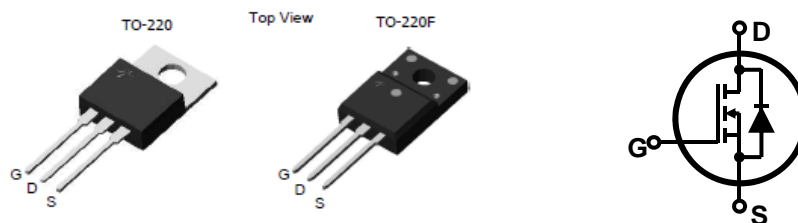

Device	Package	Marking	Remark
GP1M007A090H	TO-220	GP1M007A090H	RoHS
GP1M007A090FH	TO-220F	GP1M007A090FH	Halogen Free

## Absolute Maximum Ratings

Parameter	Symbol	GP1M007A090H	GP1M007A090FH	Unit	
Drain-Source Voltage	$V_{DSS}$	900		V	
Gate-Source Voltage	$V_{GS}$	±30		V	
Continuous Drain Current	$I_D$	$T_C = 25 \text{ }^\circ\text{C}$	7	7 *	A
		$T_C = 100 \text{ }^\circ\text{C}$	4.31	4.31 *	A
Pulsed Drain Current (Note 1)	$I_{DM}$	28	28*	A	
Single Pulse Avalanche Energy (Note 2)	$E_{AS}$	106		mJ	
Repetitive Avalanche Current (Note 1)	$I_{AR}$	7		A	
Repetitive Avalanche Energy (Note 1)	$E_{AR}$	25		mJ	
Power Dissipation	$P_D$	$T_C = 25 \text{ }^\circ\text{C}$	250	40.3	W
		Derate above 25 °C	2	0.32	W/°C
Peak Diode Recovery dv/dt (Note 3)	dv/dt	4.5		V/ns	
Operating Junction and Storage Temperature Range	$T_J, T_{STG}$	-55~150		°C	
Maximum lead temperature for soldering purposes, 1/8" from case for 5 seconds	$T_L$	300		°C	

\* Limited only by maximum junction temperature

## Thermal Characteristics

Parameter	Symbol	GP1M007A090H	GP1M007A090FH	Unit
Maximum Thermal resistance, Junction-to-Case	$R_{\theta JC}$	0.5	3.1	°C/W
Maximum Thermal resistance, Junction-to-Ambient	$R_{\theta JA}$	62.5	62.5	°C/W

**Electrical Characteristics :  $T_C=25^\circ\text{C}$ , unless otherwise noted**

Parameter	Symbol	Test condition	Min	Typ	Max	Units
<b>OFF</b>						
Drain-Source Breakdown Voltage	$BV_{DSS}$	$V_{GS} = 0\text{ V}, I_D = 250\ \mu\text{A}$	900	--	--	V
Zero Gate Voltage Drain Current	$I_{DSS}$	$V_{DS} = 900\text{ V}, V_{GS} = 0\text{ V}$	--	--	10	$\mu\text{A}$
		$V_{DS} = 720\text{ V}, T_C = 125^\circ\text{C}$	--	--	100	$\mu\text{A}$
Forward Gate-Source Leakage Current	$I_{GSSF}$	$V_{GS} = 30\text{ V}, V_{DS} = 0\text{ V}$	--	--	100	nA
Reverse Gate-Source Leakage Current	$I_{GSSR}$	$V_{GS} = -30\text{ V}, V_{DS} = 0\text{ V}$	--	--	-100	nA
<b>ON</b>						
Gate Threshold Voltage	$V_{GS(th)}$	$V_{DS} = V_{GS}, I_D = 250\ \mu\text{A}$	2	--	4	V
Drain-Source On-Resistance	$R_{DS(on)}$	$V_{GS} = 10\text{ V}, I_D = 3.5\text{ A}$	--	1.52	1.9	$\Omega$
Forward Transconductance <sup>(Note 4)</sup>	$g_{FS}$	$V_{DS} = 30\text{ V}, I_D = 3.5\text{ A}$	--	7	--	S
<b>DYNAMIC</b>						
Input Capacitance	$C_{iss}$	$V_{DS} = 25\text{ V}, V_{GS} = 0\text{ V},$ $f = 1.0\text{ MHz}$	--	1969	--	pF
Output Capacitance	$C_{oss}$		--	133	--	pF
Reverse Transfer Capacitance	$C_{rss}$		--	11	--	pF
<b>SWITCHING</b>						
Turn-On Delay Time <sup>(Note 4,5)</sup>	$t_{d(on)}$	$V_{DD} = 450\text{ V}, I_D = 7\text{ A},$ $R_G = 25\ \Omega$	--	39	--	ns
Turn-On Rise Time <sup>(Note 4,5)</sup>	$t_r$		--	38	--	ns
Turn-Off Delay Time <sup>(Note 4,5)</sup>	$t_{d(off)}$		--	155	--	ns
Turn-Off Fall Time <sup>(Note 4,5)</sup>	$t_f$		--	45	--	ns
Total Gate Charge <sup>(Note 4,5)</sup>	$Q_g$	$V_{DS} = 720\text{ V}, I_D = 7\text{ A},$ $V_{GS} = 10\text{ V}$	--	49	--	nC
Gate-Source Charge <sup>(Note 4,5)</sup>	$Q_{gs}$		--	7	--	nC
Gate-Drain Charge <sup>(Note 4,5)</sup>	$Q_{gd}$		--	20	--	nC
<b>SOURCE DRAIN DIODE</b>						
Maximum Continuous Drain-Source Diode Forward Current	$I_S$	---	--	--	7	A
Maximum Pulsed Drain-Source Diode Forward Current	$I_{SM}$	---	--	--	28	A
Drain-Source Diode Forward Voltage	$V_{SD}$	$V_{GS} = 0\text{ V}, I_S = 7\text{ A}$	--	--	1.5	V
Reverse Recovery Time <sup>(Note 4)</sup>	$t_{rr}$	$V_{GS} = 0\text{ V}, I_S = 7\text{ A}$	--	464	--	ns
Reverse Recovery Charge <sup>(Note 4)</sup>	$Q_{rr}$	$di_F / dt = 100\text{ A}/\mu\text{s}$	--	4.7	--	$\mu\text{C}$

Note :

1. Repeated rating : Pulse width limited by safe operating area
2.  $L=4.1\text{mH}, I_{AS} = 7\text{A}, V_{DD} = 50\text{V}, R_G = 25\Omega$ , Starting  $T_J = 25^\circ\text{C}$ , not subject to production test – verified by design/characterization
3.  $I_{SD} \leq 7\text{A}, di/dt \leq 200\text{A}/\mu\text{s}, V_{DD} \leq BV_{DS}$ , Starting  $T_J = 25^\circ\text{C}$
4. Pulse Test : Pulse width  $\leq 300\mu\text{s}$ , Duty Cycle  $\leq 2\%$
5. Essentially Independent of Operating Temperature Typical Characteristics

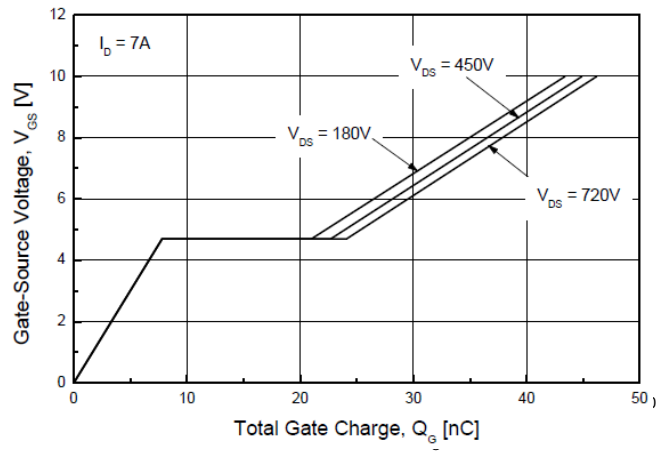
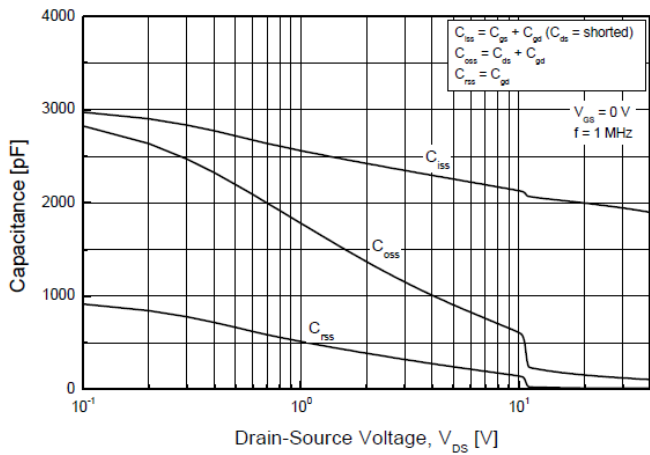
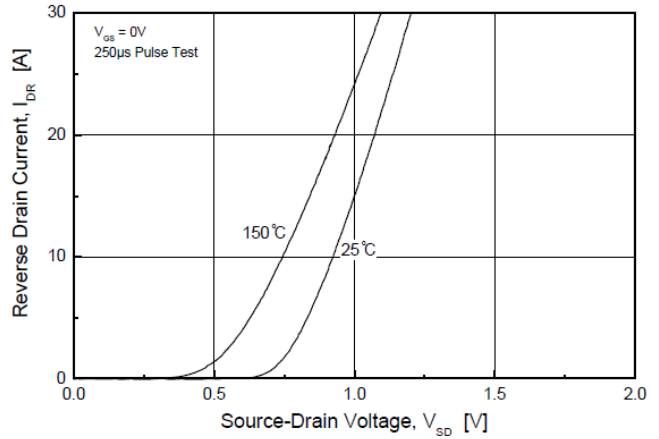
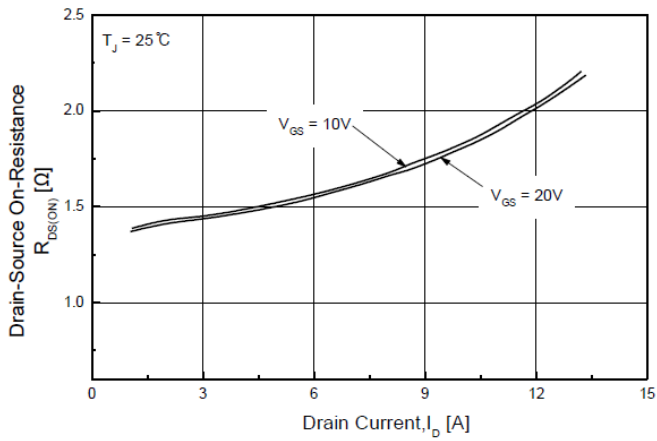
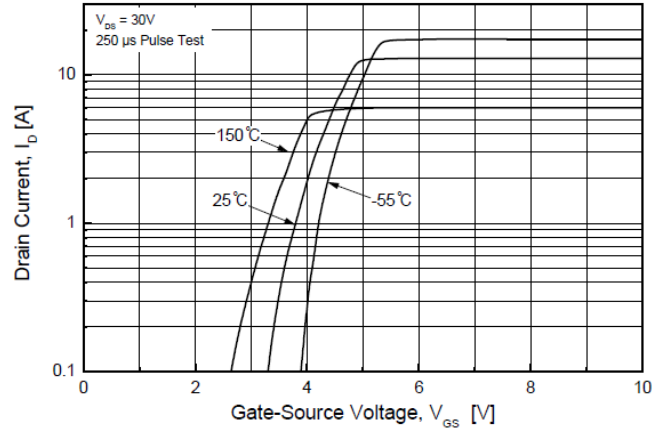
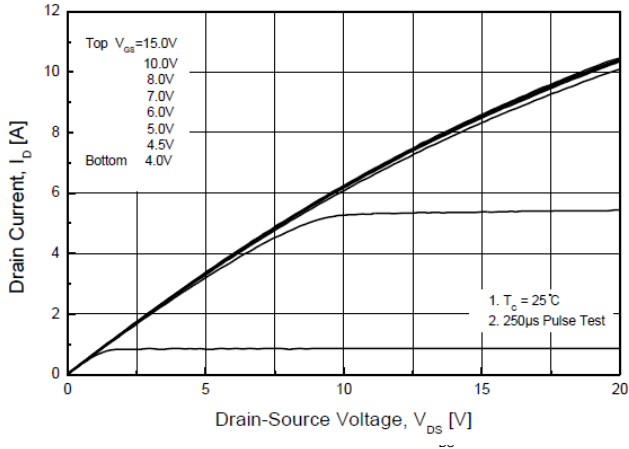

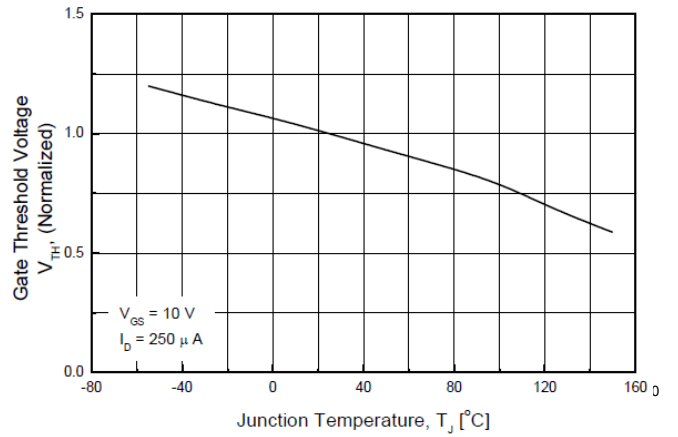
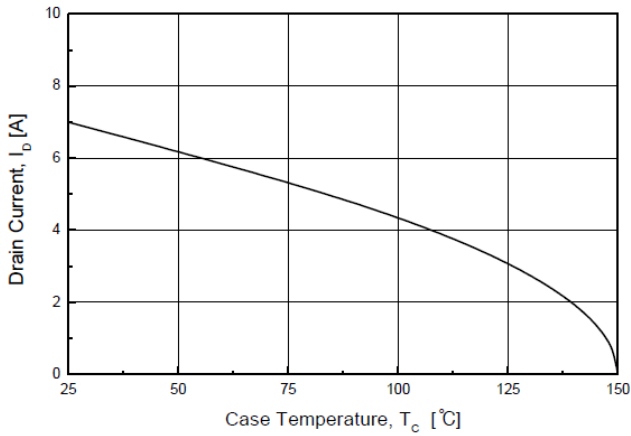
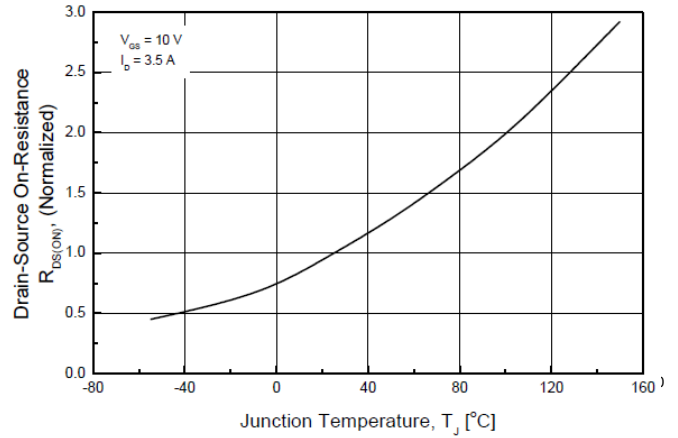
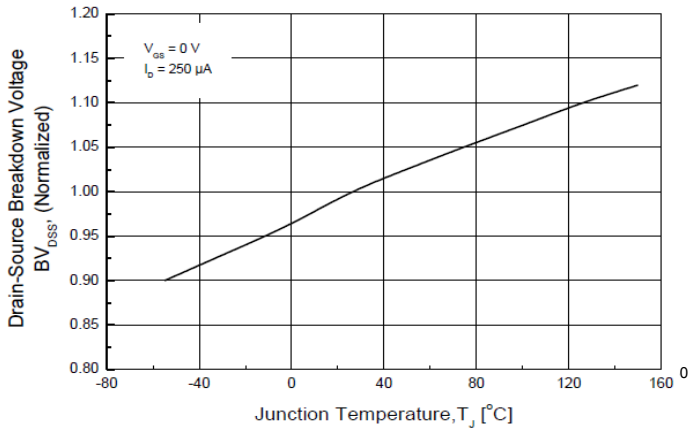

**GP1M007A090H**

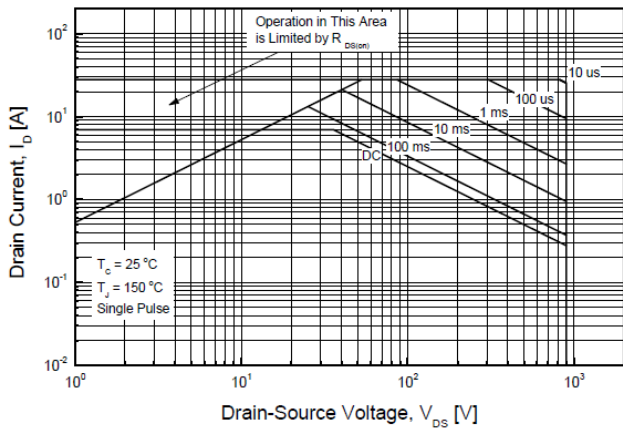

**GP1M007A090FH**

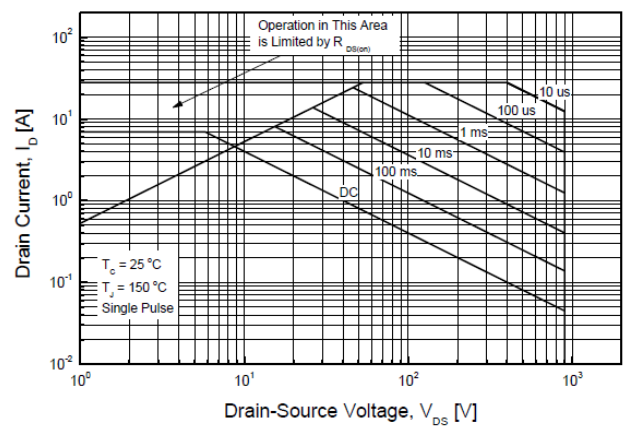

GP1M007A090H

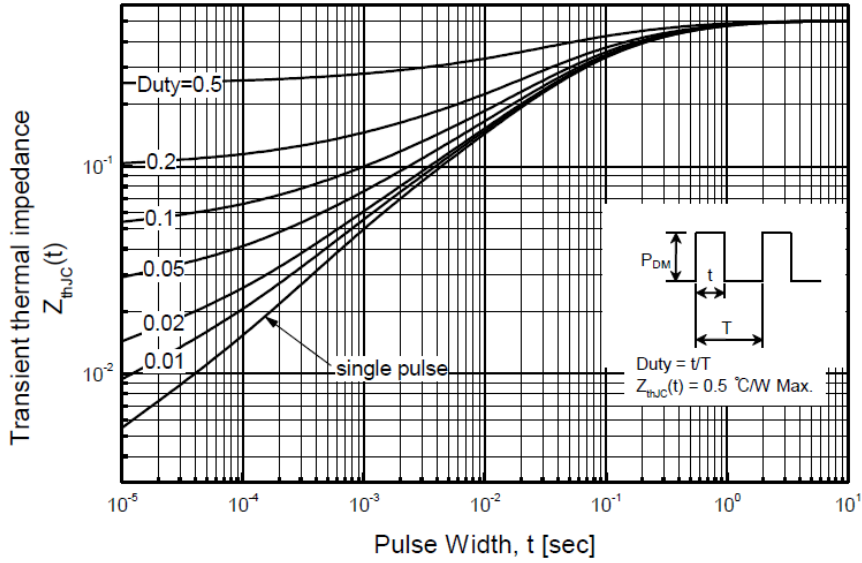

GP1M007A090FH

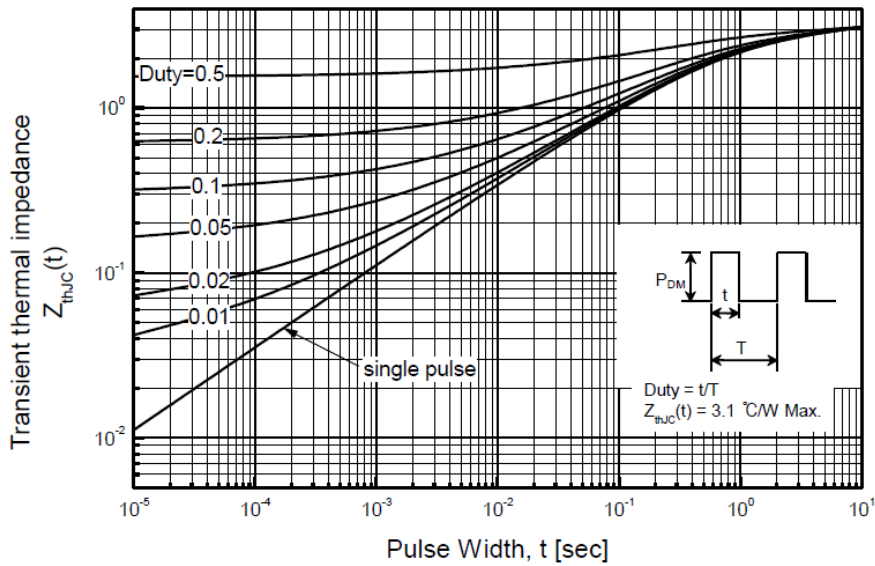

**TO-220AB-3L MECHANICAL DATA**

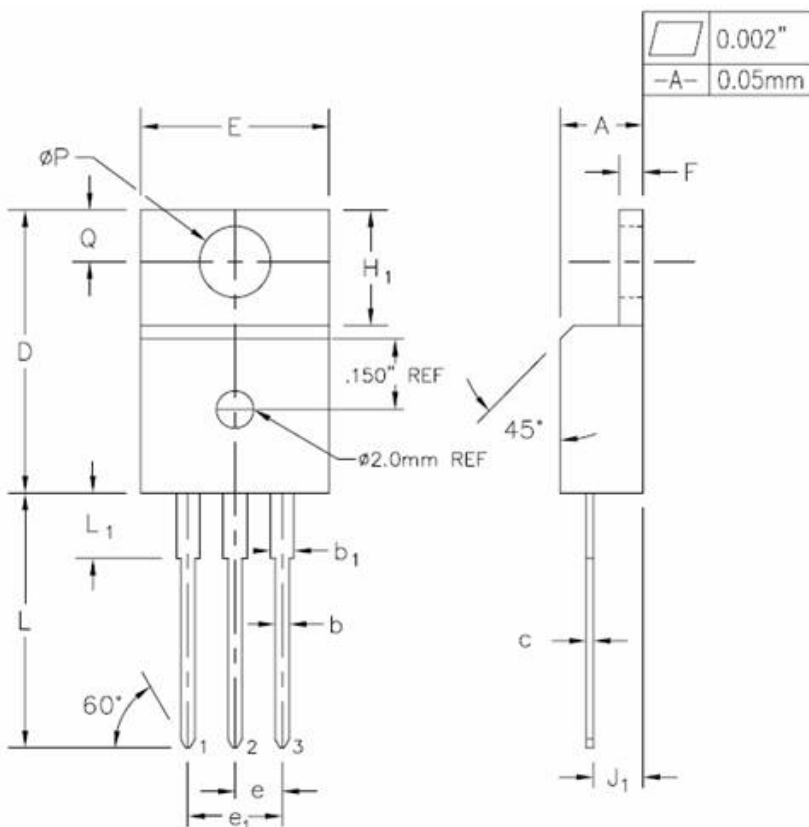

SYMBOL	INCHES		MILLIMETERS		NOTES
	MIN.	MAX.	MIN.	MAX.	
A	0.170	0.180	4.32	4.57	
b	0.028	0.036	0.71	0.91	
b <sub>1</sub>	0.045	0.055	1.15	1.39	
c	0.014	0.021	0.36	0.53	
D	0.590	0.610	14.99	15.49	
E	0.395	0.410	10.04	10.41	
e	0.100 TYP.		2.54 TYP.		
e <sub>1</sub>	0.200 BSC		5.08 BSC		
F	0.048	0.054	1.22	1.37	
H <sub>1</sub>	0.235	0.255	5.97	6.47	
J <sub>1</sub>	0.100	0.110	2.54	2.79	
L	0.530	0.550	13.47	13.97	
L <sub>1</sub>	0.130	0.150	3.31	3.81	2
∅P	0.149	0.153	3.79	3.88	
Q	0.102	0.112	2.60	2.84	

**TO-220F-3L MECHANICAL DATA**

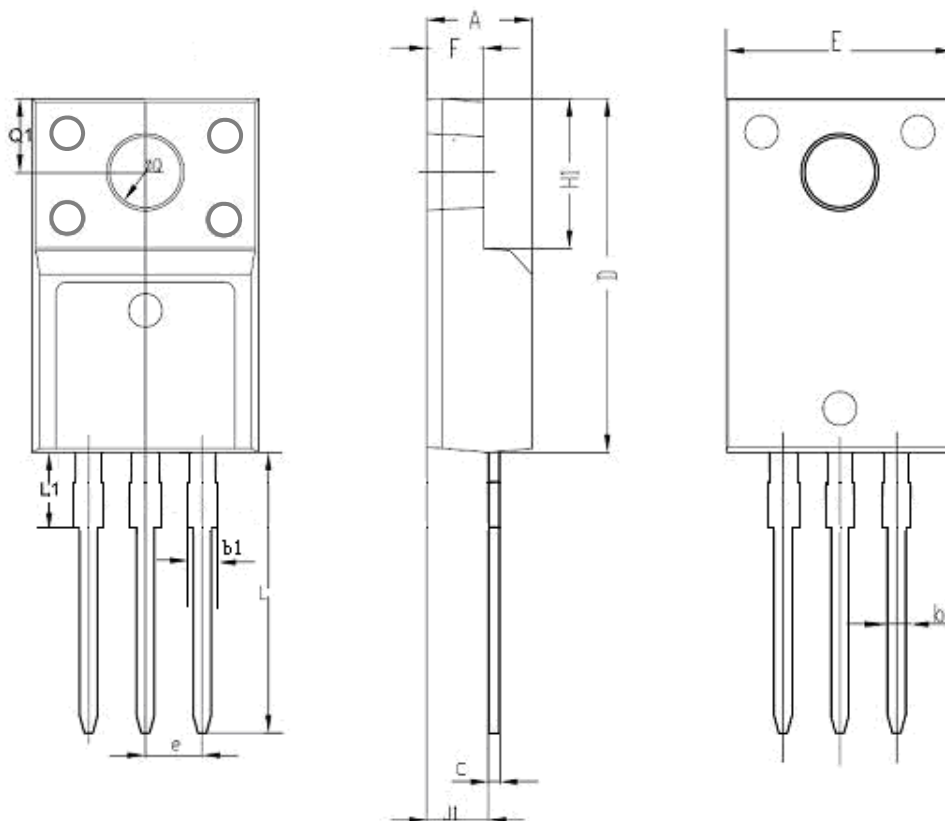

SYMBOL	INCHES		MILLIMETERS		NOTES
	MIN	MAX	MIN	MAX	
A	0.178	0.194	4.53	4.93	
b	0.028	0.036	0.71	0.91	
C	0.018	0.024	0.45	0.60	
D	0.617	0.633	15.67	16.07	
E	0.392	0.408	9.96	10.36	
e	0.100 TYP.		2.54TYP.		
H1	0.256	0.272	6.50	6.90	
J1	0.101	0.117	2.56	2.96	
L	0.503	0.519	12.78	13.18	
φQ	0.117	0.133	2.98	3.38	
b1	0.045	0.055	1.15	1.39	
L1	0.114	0.130	2.9	3.3	
Q1	0.122	0.138	3.10	3.50	
F	0.092	0.108	2.34	2.74	

**Disclaimer :**

Global Power Technologies Group reserves the right to make changes without notice to products herein to improve reliability, performance, or design. The information given in this document is believed to be accurate and reliable. However, it shall in no event be regarded as a guarantee of conditions and characteristics. With respect to any information regarding the application of the device, Global Power Technologies Group hereby disclaims any and all warranties and liabilities of any kind, including without limitation, warranties of non-infringement of patent rights of any third party.