

## Overview

Polyethylene naphthalate (PEN) film capacitor for surface mounting. Encapsulation in self-extinguishing material meeting the requirements of UL 94 V-0. GMC capacitors meet the standards according to IEC 60384-23.

## Applications

Typical applications include bypassing and signal coupling. GMC is a general purpose series designed for the highest reliability and high temperature service. Not suitable for across-the-line application (see suppressor capacitors).

## Benefits

- Rated voltage: 50 – 630 VDC
- Rated voltage: 30 – 300 VAC
- Capacitance range: 0.001 – 5.6  $\mu$ F
- EIA size: 2220 – 6560
- Capacitance tolerance:  $\pm$ 5%,  $\pm$ 10%, other tolerances on request
- Climatic category: 55/125/56
- RoHS Compliant and lead-free terminations
- Operating temperature range of  $-55^{\circ}\text{C}$  to  $+125^{\circ}\text{C}$

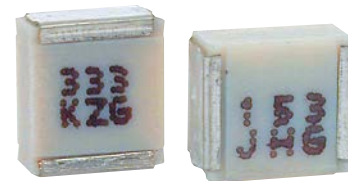

## Legacy Part Number System

GMC	5.7	102	K	50	J33	TR12
Series	Chip Length (mm)	Capacitance Code (pF)	Capacitance Tolerance	Rated Voltage (VDC)	Size Code	Packaging
Metallized PEN	5.7 7.3 10.2 12.7 16.5	First two digits indicate the two most significant digits of the capacitance value in picofarads. The third digit is the number of following zeros.	J = $\pm$ 5% K = $\pm$ 10% Other tolerances on request.	50 63 100 250 400 630	See Dimension Table	See Ordering Options Table

## New KEMET Part Number System

F	115	P	P	102	K	050	V
Capacitor Class	Series	Chip Size	Size Code	Capacitance Code (pF)	Capacitance Tolerance	Rated Voltage (VDC)	Packaging
F = Film	Metallized PEN	P = 2220 S = 2824 W = 4036 Y = 5045 Z = 6560	See Dimension Table	First two digits indicate the two most significant digits of the capacitance value in picofarads. The third digit is the number of following zeros.	J = $\pm$ 5% K = $\pm$ 10% Other tolerances on request.	050 = 50 063 = 63 100 = 100 250 = 250 400 = 400 630 = 630	See Ordering Options Table

## Ordering Options Table

Chip Size (EIA)	Packaging Type	KEMET Packaging Code	Legacy Packaging Code
2220	<b>Standard Packaging Options</b>		
	Tape & Reel (Standard Reel)	V	TR12
	Bulk (Bag)	A	BULK
2824	<b>Standard Packaging Options</b>		
	Tape & Reel (Standard Reel)	V	TR12
	Bulk (Bag)	A	BULK
4036	<b>Standard Packaging Options</b>		
	Tape & Reel (Standard Reel)	V	TR16
	Bulk (Bag)	A	BULK
	<b>Other Packaging Options</b>		
	Tape & Reel (Vertical Orientation Standard Reel)	Y	TV24
5045	<b>Standard Packaging Options</b>		
	Tape & Reel (Standard Reel)	V	TR24
	Bulk (Bag)	A	BULK
	<b>Other Packaging Options</b>		
	Tape & Reel (Vertical Orientation Standard Reel)	Y	TV24
6560	<b>Standard Packaging Options</b>		
	Tape & Reel (Standard Reel)	V	TR24
	Bulk (Bag)	A	BULK
	<b>Other Packaging Options</b>		
	Tape & Reel (Vertical Orientation Standard Reel)	Y	TV44

## Dimensions – Millimeters

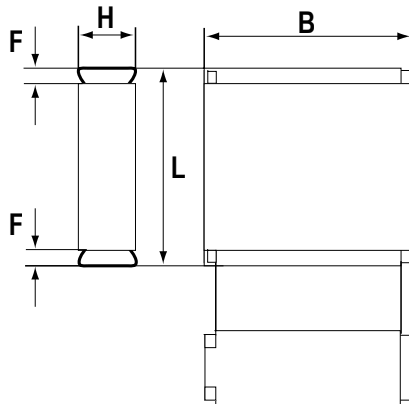

KEMET Size Code	Legacy Size Code	Chip Size (EIA)	B		H		L		F	
			Nominal	Tolerance	Nominal	Tolerance	Nominal	Tolerance	Nominal	Tolerance
PP	J33	2220	5.0	+/-0.2	3.0	+/-0.2	5.7	+/-0.2	0.5	Nominal
PU	J35	2220	5.0	+/-0.2	4.0	+/-0.2	5.7	+/-0.2	0.5	Nominal
SL	K33	2824	6.0	+/-0.2	3.0	+/-0.2	7.3	+/-0.2	0.5	Nominal
SP	K35	2824	6.0	+/-0.2	3.5	+/-0.2	7.3	+/-0.2	0.5	Nominal
ST	K37	2824	6.0	+/-0.2	4.5	+/-0.2	7.3	+/-0.2	0.5	Nominal
WP	A31	4036	9.1	+/-0.2	5.5	+/-0.2	10.2	+/-0.2	0.5	Nominal
YR	B31	5045	11.5	+/-0.2	6.5	+/-0.2	12.7	+/-0.2	0.5	Nominal
ZS	C31	6560	15	+/-0.2	7.0	+/-0.2	16.5	+/-0.2	0.5	Nominal

## Environmental Compliance

All KEMET surface mount capacitors are RoHS Compliant.

## Performance Characteristics

Rated Voltage (VDC)	50	63	100	250	400	630
Rated Voltage (VAC)	30	40	63	160	200	300
Capacitance Range (μF)	0.001 – 5.6	0.001 – 4.7	0.001 – 2.2	0.001 – 0.68	0.001 – 0.33	0.022-0.15
Chip Size (EIA)	2220 – 6560					
Capacitance Tolerance	±5%, ±10%, other tolerances on request					
Category Temperature Range	-55°C to +125°C					
Rated Temperature	+100°C					
Voltage Derating	The rated voltage should be decreased with 1.25%/°C from +100°C to +125°C and 1.5%/°C from +125°C to 175°C					
Climatic Category	55/125/56					
Test Voltage	1.6 x V <sub>R</sub> , 60 seconds					
Insulation Resistance	Measured at +20°C According to IEC 60384-19					
	Minimum Value Between Terminals					
		C ≤ 0.33 μF		C > 0.33 μF		
	V <sub>R</sub> ≤ 100	10,000 MΩ		3,000 MΩ • μF		
	V <sub>R</sub> > 100	30,000 MΩ		10,000 MΩ • μF		
Dissipation Factor	Maximum Values at +23°C					
		C ≤ 0.1 μF	0.1 < C ≤ 1 μF		C > 1 μF	
	1 kHz	0.6%	0.6%		0.6%	
	10 kHz	1.0%	1.0%		1.0%	
	100 kHz	2.0%	2.5%			
Pulse Rise Time	The capacitors can withstand an unlimited number of pulses with a dV/dt according to Table 1. For voltages (V) lower than the rated voltage (V <sub>R</sub> ), the specified dV/dt can be multiplied by V <sub>R</sub> /V.					

### Capacitance vs. Temperature

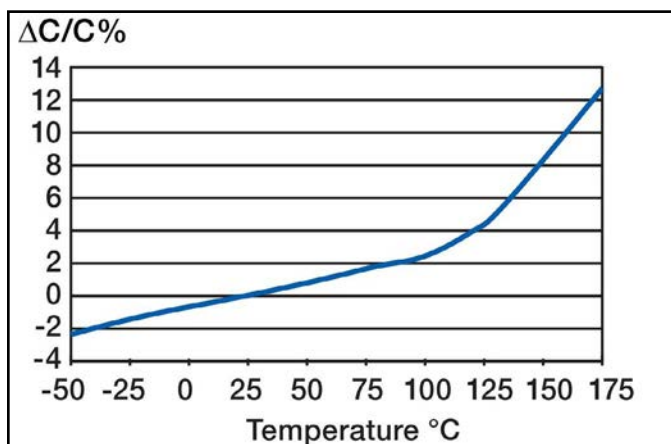

### Dissipation Factor vs. Temperature

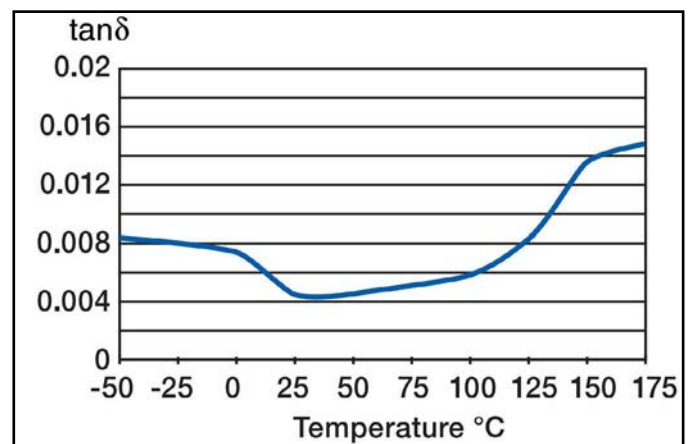

**Table 1 – Ratings & Part Number Reference**

VDC	VAC	Cap Value ( $\mu$ F)	Size Code (New/Legacy)	Dimensions in mm			Chip Size	dV/dt (V/ $\mu$ s)	New KEMET Part Number	Legacy Part Number
				B	H	L				
50	30	0.0010	PP/J33	5.0	3.0	5.7	2220	40	F115PP102(1)050(2)	GMC5.7102(1)50J33(2)
50	30	0.0012	PP/J33	5.0	3.0	5.7	2220	40	F115PP122(1)050(2)	GMC5.7122(1)50J33(2)
50	30	0.0015	PP/J33	5.0	3.0	5.7	2220	40	F115PP152(1)050(2)	GMC5.7152(1)50J33(2)
50	30	0.0018	PP/J33	5.0	3.0	5.7	2220	40	F115PP182(1)050(2)	GMC5.7182(1)50J33(2)
50	30	0.0022	PP/J33	5.0	3.0	5.7	2220	40	F115PP222(1)050(2)	GMC5.7222(1)50J33(2)
50	30	0.0027	PP/J33	5.0	3.0	5.7	2220	40	F115PP272(1)050(2)	GMC5.7272(1)50J33(2)
50	30	0.0033	PP/J33	5.0	3.0	5.7	2220	40	F115PP332(1)050(2)	GMC5.7332(1)50J33(2)
50	30	0.0039	PP/J33	5.0	3.0	5.7	2220	40	F115PP392(1)050(2)	GMC5.7392(1)50J33(2)
50	30	0.0047	PP/J33	5.0	3.0	5.7	2220	40	F115PP472(1)050(2)	GMC5.7472(1)50J33(2)
50	30	0.0056	PP/J33	5.0	3.0	5.7	2220	40	F115PP562(1)050(2)	GMC5.7562(1)50J33(2)
50	30	0.0068	PP/J33	5.0	3.0	5.7	2220	40	F115PP682(1)050(2)	GMC5.7682(1)50J33(2)
50	30	0.0082	PP/J33	5.0	3.0	5.7	2220	40	F115PP822(1)050(2)	GMC5.7822(1)50J33(2)
50	30	0.010	PP/J33	5.0	3.0	5.7	2220	40	F115PP103(1)050(2)	GMC5.7103(1)50J33(2)
50	30	0.012	PP/J33	5.0	3.0	5.7	2220	40	F115PP123(1)050(2)	GMC5.7123(1)50J33(2)
50	30	0.015	PP/J33	5.0	3.0	5.7	2220	30	F115PP153(1)050(2)	GMC5.7153(1)50J33(2)
50	30	0.018	PP/J33	5.0	3.0	5.7	2220	30	F115PP183(1)050(2)	GMC5.7183(1)50J33(2)
50	30	0.022	PP/J33	5.0	3.0	5.7	2220	30	F115PP223(1)050(2)	GMC5.7223(1)50J33(2)
50	30	0.027	PP/J33	5.0	3.0	5.7	2220	30	F115PP273(1)050(2)	GMC5.7273(1)50J33(2)
50	30	0.033	PP/J33	5.0	3.0	5.7	2220	20	F115PP333(1)050(2)	GMC5.7333(1)50J33(2)
50	30	0.039	PP/J33	5.0	3.0	5.7	2220	20	F115PP393(1)050(2)	GMC5.7393(1)50J33(2)
50	30	0.047	PP/J33	5.0	3.0	5.7	2220	20	F115PP473(1)050(2)	GMC5.7473(1)50J33(2)
50	30	0.056	PP/J33	5.0	3.0	5.7	2220	20	F115PP563(1)050(2)	GMC5.7563(1)50J33(2)
50	30	0.068	PP/J33	5.0	3.0	5.7	2220	20	F115PP683(1)050(2)	GMC5.7683(1)50J33(2)
50	30	0.082	PP/J33	5.0	3.0	5.7	2220	20	F115PP823(1)050(2)	GMC5.7823(1)50J33(2)
50	30	0.10	PP/J33	5.0	3.0	5.7	2220	20	F115PP104(1)050(2)	GMC5.7104(1)50J33(2)
50	30	0.12	PP/J33	5.0	3.0	5.7	2220	20	F115PP124(1)050(2)	GMC5.7124(1)50J33(2)
50	30	0.15	PU/J35	5.0	4.0	5.7	2220	20	F115PU154(1)050(2)	GMC5.7154(1)50J35(2)
50	30	0.18	PU/J35	5.0	4.0	5.7	2220	20	F115PU184(1)050(2)	GMC5.7184(1)50J35(2)
50	30	0.022	WP/A31	9.1	5.5	10.2	4036	40	F115WP223(1)050(2)	GMC10.2223(1)50A31(2)
50	30	0.027	WP/A31	9.1	5.5	10.2	4036	40	F115WP273(1)050(2)	GMC10.2273(1)50A31(2)
50	30	0.033	WP/A31	9.1	5.5	10.2	4036	40	F115WP333(1)050(2)	GMC10.2333(1)50A31(2)
50	30	0.039	WP/A31	9.1	5.5	10.2	4036	40	F115WP393(1)050(2)	GMC10.2393(1)50A31(2)
50	30	0.047	WP/A31	9.1	5.5	10.2	4036	30	F115WP473(1)050(2)	GMC10.2473(1)50A31(2)
50	30	0.056	WP/A31	9.1	5.5	10.2	4036	30	F115WP563(1)050(2)	GMC10.2563(1)50A31(2)
50	30	0.068	WP/A31	9.1	5.5	10.2	4036	30	F115WP683(1)050(2)	GMC10.2683(1)50A31(2)
50	30	0.082	WP/A31	9.1	5.5	10.2	4036	30	F115WP823(1)050(2)	GMC10.2823(1)50A31(2)
50	30	0.10	WP/A31	9.1	5.5	10.2	4036	30	F115WP104(1)050(2)	GMC10.2104(1)50A31(2)
50	30	0.12	WP/A31	9.1	5.5	10.2	4036	30	F115WP124(1)050(2)	GMC10.2124(1)50A31(2)
50	30	0.15	WP/A31	9.1	5.5	10.2	4036	20	F115WP154(1)050(2)	GMC10.2154(1)50A31(2)
50	30	0.18	WP/A31	9.1	5.5	10.2	4036	20	F115WP184(1)050(2)	GMC10.2184(1)50A31(2)
50	30	0.22	WP/A31	9.1	5.5	10.2	4036	20	F115WP224(1)050(2)	GMC10.2224(1)50A31(2)
50	30	0.27	WP/A31	9.1	5.5	10.2	4036	20	F115WP274(1)050(2)	GMC10.2274(1)50A31(2)
50	30	0.33	WP/A31	9.1	5.5	10.2	4036	20	F115WP334(1)050(2)	GMC10.2334(1)50A31(2)
50	30	0.39	WP/A31	9.1	5.5	10.2	4036	10	F115WP394(1)050(2)	GMC10.2394(1)50A31(2)
50	30	0.47	WP/A31	9.1	5.5	10.2	4036	10	F115WP474(1)050(2)	GMC10.2474(1)50A31(2)
50	30	0.56	WP/A31	9.1	5.5	10.2	4036	10	F115WP564(1)050(2)	GMC10.2564(1)50A31(2)
50	30	0.68	WP/A31	9.1	5.5	10.2	4036	10	F115WP684(1)050(2)	GMC10.2684(1)50A31(2)
50	30	0.82	WP/A31	9.1	5.5	10.2	4036	10	F115WP824(1)050(2)	GMC10.2824(1)50A31(2)
50	30	1.0	WP/A31	9.1	5.5	10.2	4036	10	F115WP105(1)050(2)	GMC10.2105(1)50A31(2)
50	30	1.2	WP/A31	9.1	5.5	10.2	4036	10	F115WP125(1)050(2)	GMC10.2125(1)50A31(2)
50	30	1.5	YR/B31	11.5	6.5	12.7	5045	8	F115YR155(1)050(2)	GMC12.7155(1)50B31(2)
50	30	1.8	YR/B31	11.5	6.5	12.7	5045	8	F115YR185(1)050(2)	GMC12.7185(1)50B31(2)
50	30	2.2	YR/B31	11.5	6.5	12.7	5045	8	F115YR225(1)050(2)	GMC12.7225(1)50B31(2)
50	30	2.7	YR/B31	11.5	6.5	12.7	5045	8	F115YR275(1)050(2)	GMC12.7275(1)50B31(2)
50	30	3.0	YR/B31	11.5	6.5	12.7	5045	8	F115YR305(1)050(2)	GMC12.7305(1)50B31(2)
50	30	3.9	ZS/C31	15.0	7.0	16.5	6560	5	F115ZS395(1)050(2)	GMC16.5395(1)50C31(2)
50	30	4.7	ZS/C31	15.0	7.0	16.5	6560	5	F115ZS475(1)050(2)	GMC16.5475(1)50C31(2)
50	30	5.6	ZS/C31	15.0	7.0	16.5	6560	5	F115ZS565(1)050(2)	GMC16.5565(1)50C31(2)
63	40	0.0010	SL/K33	6.0	3.0	7.3	2824	50	F115SL102(1)063(2)	GMC7.3102(1)63K33(2)
VDC	VAC	Capacitance Value ( $\mu$ F)	Size Code (New/Legacy)	B (mm)	H (mm)	L (mm)	Chip Size	dV/dt (V/ $\mu$ s)	New KEMET Part Number	Legacy Part Number

(1) J =  $\pm$ 5%, K =  $\pm$ 10%, other tolerances on request.

(2) Insert ordering code for lead type and packaging. See Ordering Options Table for available options.

**Table 1 – Ratings & Part Number Reference cont'd**

VDC	VAC	Cap Value ( $\mu$ F)	Size Code (New/Legacy)	Dimensions in mm			Chip Size	dV/dt (V/ $\mu$ s)	New KEMET Part Number	Legacy Part Number
				B	H	L				
63	40	0.0012	SL/K33	6.0	3.0	7.3	2824	50	F115SL122(1)063(2)	GMC7.3122(1)63K33(2)
63	40	0.0015	SL/K33	6.0	3.0	7.3	2824	50	F115SL152(1)063(2)	GMC7.3152(1)63K33(2)
63	40	0.0018	SL/K33	6.0	3.0	7.3	2824	50	F115SL182(1)063(2)	GMC7.3182(1)63K33(2)
63	40	0.0022	SL/K33	6.0	3.0	7.3	2824	50	F115SL222(1)063(2)	GMC7.3222(1)63K33(2)
63	40	0.0027	SL/K33	6.0	3.0	7.3	2824	50	F115SL272(1)063(2)	GMC7.3272(1)63K33(2)
63	40	0.0033	SL/K33	6.0	3.0	7.3	2824	50	F115SL332(1)063(2)	GMC7.3332(1)63K33(2)
63	40	0.0039	SL/K33	6.0	3.0	7.3	2824	50	F115SL392(1)063(2)	GMC7.3392(1)63K33(2)
63	40	0.0047	SL/K33	6.0	3.0	7.3	2824	50	F115SL472(1)063(2)	GMC7.3472(1)63K33(2)
63	40	0.0056	SL/K33	6.0	3.0	7.3	2824	50	F115SL562(1)063(2)	GMC7.3562(1)63K33(2)
63	40	0.0068	SL/K33	6.0	3.0	7.3	2824	40	F115SL682(1)063(2)	GMC7.3682(1)63K33(2)
63	40	0.0082	SL/K33	6.0	3.0	7.3	2824	40	F115SL822(1)063(2)	GMC7.3822(1)63K33(2)
63	40	0.010	SL/K33	6.0	3.0	7.3	2824	40	F115SL103(1)063(2)	GMC7.3103(1)63K33(2)
63	40	0.012	SL/K33	6.0	3.0	7.3	2824	40	F115SL123(1)063(2)	GMC7.3123(1)63K33(2)
63	40	0.015	SL/K33	6.0	3.0	7.3	2824	40	F115SL153(1)063(2)	GMC7.3153(1)63K33(2)
63	40	0.018	SL/K33	6.0	3.0	7.3	2824	40	F115SL183(1)063(2)	GMC7.3183(1)63K33(2)
63	40	0.022	SL/K33	6.0	3.0	7.3	2824	30	F115SL223(1)063(2)	GMC7.3223(1)63K33(2)
63	40	0.027	SL/K33	6.0	3.0	7.3	2824	30	F115SL273(1)063(2)	GMC7.3273(1)63K33(2)
63	40	0.033	SL/K33	6.0	3.0	7.3	2824	30	F115SL333(1)063(2)	GMC7.3333(1)63K33(2)
63	40	0.039	SL/K33	6.0	3.0	7.3	2824	30	F115SL393(1)063(2)	GMC7.3393(1)63K33(2)
63	40	0.047	SL/K33	6.0	3.0	7.3	2824	30	F115SL473(1)063(2)	GMC7.3473(1)63K33(2)
63	40	0.056	SL/K33	6.0	3.0	7.3	2824	30	F115SL563(1)063(2)	GMC7.3563(1)63K33(2)
63	40	0.068	SL/K33	6.0	3.0	7.3	2824	20	F115SL683(1)063(2)	GMC7.3683(1)63K33(2)
63	40	0.082	SL/K33	6.0	3.0	7.3	2824	20	F115SL823(1)063(2)	GMC7.3823(1)63K33(2)
63	40	0.10	SL/K33	6.0	3.0	7.3	2824	20	F115SL104(1)063(2)	GMC7.3104(1)63K33(2)
63	40	0.12	SL/K33	6.0	3.0	7.3	2824	20	F115SL124(1)063(2)	GMC7.3124(1)63K33(2)
63	40	0.15	SL/K33	6.0	3.0	7.3	2824	20	F115SL154(1)063(2)	GMC7.3154(1)63K33(2)
63	40	0.18	SL/K33	6.0	3.0	7.3	2824	20	F115SL184(1)063(2)	GMC7.3184(1)63K33(2)
63	40	0.22	SL/K33	6.0	3.0	7.3	2824	20	F115SL224(1)063(2)	GMC7.3224(1)63K33(2)
63	40	0.27	SP/K35	6.0	3.5	7.3	2824	20	F115SP274(1)063(2)	GMC7.3274(1)63K35(2)
63	40	0.33	SP/K35	6.0	3.5	7.3	2824	20	F115SP334(1)063(2)	GMC7.3334(1)63K35(2)
63	40	0.39	ST/K37	6.0	4.5	7.3	2824	20	F115ST394(1)063(2)	GMC7.3394(1)63K37(2)
63	40	0.022	WP/A31	9.1	5.5	10.2	4036	40	F115WP223(1)063(2)	GMC10.2223(1)63A31(2)
63	40	0.027	WP/A31	9.1	5.5	10.2	4036	40	F115WP273(1)063(2)	GMC10.2273(1)63A31(2)
63	40	0.033	WP/A31	9.1	5.5	10.2	4036	40	F115WP333(1)063(2)	GMC10.2333(1)63A31(2)
63	40	0.039	WP/A31	9.1	5.5	10.2	4036	40	F115WP393(1)063(2)	GMC10.2393(1)63A31(2)
63	40	0.047	WP/A31	9.1	5.5	10.2	4036	30	F115WP473(1)063(2)	GMC10.2473(1)63A31(2)
63	40	0.056	WP/A31	9.1	5.5	10.2	4036	30	F115WP563(1)063(2)	GMC10.2563(1)63A31(2)
63	40	0.068	WP/A31	9.1	5.5	10.2	4036	30	F115WP683(1)063(2)	GMC10.2683(1)63A31(2)
63	40	0.082	WP/A31	9.1	5.5	10.2	4036	30	F115WP823(1)063(2)	GMC10.2823(1)63A31(2)
63	40	0.10	WP/A31	9.1	5.5	10.2	4036	30	F115WP104(1)063(2)	GMC10.2104(1)63A31(2)
63	40	0.12	WP/A31	9.1	5.5	10.2	4036	30	F115WP124(1)063(2)	GMC10.2124(1)63A31(2)
63	40	0.15	WP/A31	9.1	5.5	10.2	4036	20	F115WP154(1)063(2)	GMC10.2154(1)63A31(2)
63	40	0.18	WP/A31	9.1	5.5	10.2	4036	20	F115WP184(1)063(2)	GMC10.2184(1)63A31(2)
63	40	0.22	WP/A31	9.1	5.5	10.2	4036	20	F115WP224(1)063(2)	GMC10.2224(1)63A31(2)
63	40	0.27	WP/A31	9.1	5.5	10.2	4036	20	F115WP274(1)063(2)	GMC10.2274(1)63A31(2)
63	40	0.33	WP/A31	9.1	5.5	10.2	4036	20	F115WP334(1)063(2)	GMC10.2334(1)63A31(2)
63	40	0.39	WP/A31	9.1	5.5	10.2	4036	10	F115WP394(1)063(2)	GMC10.2394(1)63A31(2)
63	40	0.47	WP/A31	9.1	5.5	10.2	4036	10	F115WP474(1)063(2)	GMC10.2474(1)63A31(2)
63	40	0.56	WP/A31	9.1	5.5	10.2	4036	10	F115WP564(1)063(2)	GMC10.2564(1)63A31(2)
63	40	0.68	WP/A31	9.1	5.5	10.2	4036	10	F115WP684(1)063(2)	GMC10.2684(1)63A31(2)
63	40	0.82	WP/A31	9.1	5.5	10.2	4036	10	F115WP824(1)063(2)	GMC10.2824(1)63A31(2)
63	40	1.0	YR/B31	11.5	6.5	12.7	5045	8	F115YR105(1)063(2)	GMC12.7105(1)63B31(2)
63	40	1.2	YR/B31	11.5	6.5	12.7	5045	8	F115YR125(1)063(2)	GMC12.7125(1)63B31(2)
63	40	1.5	YR/B31	11.5	6.5	12.7	5045	8	F115YR155(1)063(2)	GMC12.7155(1)63B31(2)
63	40	1.8	ZS/C31	15.0	7.0	16.5	6560	5	F115ZS185(1)063(2)	GMC16.5185(1)63C31(2)
63	40	2.2	ZS/C31	15.0	7.0	16.5	6560	5	F115ZS225(1)063(2)	GMC16.5225(1)63C31(2)
63	40	2.7	ZS/C31	15.0	7.0	16.5	6560	5	F115ZS275(1)063(2)	GMC16.5275(1)63C31(2)
63	40	3.3	ZS/C31	15.0	7.0	16.5	6560	5	F115ZS335(1)063(2)	GMC16.5335(1)63C31(2)
63	40	3.9	ZS/C31	15.0	7.0	16.5	6560	5	F115ZS395(1)063(2)	GMC16.5395(1)63C31(2)
VDC	VAC	Capacitance Value ( $\mu$ F)	Size Code (New/Legacy)	B (mm)	H (mm)	L (mm)	Chip Size	dV/dt (V/ $\mu$ s)	New KEMET Part Number	Legacy Part Number

(1) J =  $\pm$ 5%, K =  $\pm$ 10%, other tolerances on request.

(2) Insert ordering code for lead type and packaging. See Ordering Options Table for available options.

**Table 1 – Ratings & Part Number Reference cont'd**

VDC	VAC	Cap Value ( $\mu$ F)	Size Code (New/Legacy)	Dimensions in mm			Chip Size	dV/dt (V/ $\mu$ s)	New KEMET Part Number	Legacy Part Number
				B	H	L				
63	40	4.7	ZS/C31	15.0	7.0	16.5	6560	5	F115ZS475(1)063(2)	GMC16.5475(1)63C31(2)
100	63	0.0010	PP/J33	5.0	3.0	5.7	2220	40	F115PP102(1)100(2)	GMC5.7102(1)100J33(2)
100	63	0.0012	PP/J33	5.0	3.0	5.7	2220	40	F115PP122(1)100(2)	GMC5.7122(1)100J33(2)
100	63	0.0015	PP/J33	5.0	3.0	5.7	2220	40	F115PP152(1)100(2)	GMC5.7152(1)100J33(2)
100	63	0.0018	PP/J33	5.0	3.0	5.7	2220	40	F115PP182(1)100(2)	GMC5.7182(1)100J33(2)
100	63	0.0022	PP/J33	5.0	3.0	5.7	2220	40	F115PP222(1)100(2)	GMC5.7222(1)100J33(2)
100	63	0.0027	PP/J33	5.0	3.0	5.7	2220	40	F115PP272(1)100(2)	GMC5.7272(1)100J33(2)
100	63	0.0033	PP/J33	5.0	3.0	5.7	2220	40	F115PP332(1)100(2)	GMC5.7332(1)100J33(2)
100	63	0.0039	PP/J33	5.0	3.0	5.7	2220	40	F115PP392(1)100(2)	GMC5.7392(1)100J33(2)
100	63	0.0047	PP/J33	5.0	3.0	5.7	2220	40	F115PP472(1)100(2)	GMC5.7472(1)100J33(2)
100	63	0.0056	PP/J33	5.0	3.0	5.7	2220	40	F115PP562(1)100(2)	GMC5.7562(1)100J33(2)
100	63	0.0068	PP/J33	5.0	3.0	5.7	2220	40	F115PP682(1)100(2)	GMC5.7682(1)100J33(2)
100	63	0.0082	PP/J33	5.0	3.0	5.7	2220	40	F115PP822(1)100(2)	GMC5.7822(1)100J33(2)
100	63	0.010	PP/J33	5.0	3.0	5.7	2220	40	F115PP103(1)100(2)	GMC5.7103(1)100J33(2)
100	63	0.012	PP/J33	5.0	3.0	5.7	2220	40	F115PP123(1)100(2)	GMC5.7123(1)100J33(2)
100	63	0.015	PP/J33	5.0	3.0	5.7	2220	30	F115PP153(1)100(2)	GMC5.7153(1)100J33(2)
100	63	0.018	PP/J33	5.0	3.0	5.7	2220	30	F115PP183(1)100(2)	GMC5.7183(1)100J33(2)
100	63	0.022	PP/J33	5.0	3.0	5.7	2220	30	F115PP223(1)100(2)	GMC5.7223(1)100J33(2)
100	63	0.027	PP/J33	5.0	3.0	5.7	2220	30	F115PP273(1)100(2)	GMC5.7273(1)100J33(2)
100	63	0.033	PP/J33	5.0	3.0	5.7	2220	30	F115PP333(1)100(2)	GMC5.7333(1)100J33(2)
100	63	0.039	PU/J35	5.0	4.0	5.7	2220	30	F115PU393(1)100(2)	GMC5.7393(1)100J35(2)
100	63	0.047	PU/J35	5.0	4.0	5.7	2220	30	F115PU473(1)100(2)	GMC5.7473(1)100J35(2)
100	63	0.0010	SL/K33	6.0	3.0	7.3	2824	50	F115SL102(1)100(2)	GMC7.3102(1)100K33(2)
100	63	0.0012	SL/K33	6.0	3.0	7.3	2824	50	F115SL122(1)100(2)	GMC7.3122(1)100K33(2)
100	63	0.0015	SL/K33	6.0	3.0	7.3	2824	50	F115SL152(1)100(2)	GMC7.3152(1)100K33(2)
100	63	0.0018	SL/K33	6.0	3.0	7.3	2824	50	F115SL182(1)100(2)	GMC7.3182(1)100K33(2)
100	63	0.0022	SL/K33	6.0	3.0	7.3	2824	50	F115SL222(1)100(2)	GMC7.3222(1)100K33(2)
100	63	0.0027	SL/K33	6.0	3.0	7.3	2824	50	F115SL272(1)100(2)	GMC7.3272(1)100K33(2)
100	63	0.0033	SL/K33	6.0	3.0	7.3	2824	50	F115SL332(1)100(2)	GMC7.3332(1)100K33(2)
100	63	0.0039	SL/K33	6.0	3.0	7.3	2824	50	F115SL392(1)100(2)	GMC7.3392(1)100K33(2)
100	63	0.0047	SL/K33	6.0	3.0	7.3	2824	50	F115SL472(1)100(2)	GMC7.3472(1)100K33(2)
100	63	0.0056	SL/K33	6.0	3.0	7.3	2824	50	F115SL562(1)100(2)	GMC7.3562(1)100K33(2)
100	63	0.0068	SL/K33	6.0	3.0	7.3	2824	40	F115SL682(1)100(2)	GMC7.3682(1)100K33(2)
100	63	0.0082	SL/K33	6.0	3.0	7.3	2824	40	F115SL822(1)100(2)	GMC7.3822(1)100K33(2)
100	63	0.010	SL/K33	6.0	3.0	7.3	2824	40	F115SL103(1)100(2)	GMC7.3103(1)100K33(2)
100	63	0.012	SL/K33	6.0	3.0	7.3	2824	40	F115SL123(1)100(2)	GMC7.3123(1)100K33(2)
100	63	0.015	SL/K33	6.0	3.0	7.3	2824	40	F115SL153(1)100(2)	GMC7.3153(1)100K33(2)
100	63	0.018	SL/K33	6.0	3.0	7.3	2824	40	F115SL183(1)100(2)	GMC7.3183(1)100K33(2)
100	63	0.022	SL/K33	6.0	3.0	7.3	2824	30	F115SL223(1)100(2)	GMC7.3223(1)100K33(2)
100	63	0.027	SL/K33	6.0	3.0	7.3	2824	30	F115SL273(1)100(2)	GMC7.3273(1)100K33(2)
100	63	0.033	SL/K33	6.0	3.0	7.3	2824	30	F115SL333(1)100(2)	GMC7.3333(1)100K33(2)
100	63	0.039	SL/K33	6.0	3.0	7.3	2824	30	F115SL393(1)100(2)	GMC7.3393(1)100K33(2)
100	63	0.047	SL/K33	6.0	3.0	7.3	2824	30	F115SL473(1)100(2)	GMC7.3473(1)100K33(2)
100	63	0.056	SL/K33	6.0	3.0	7.3	2824	30	F115SL563(1)100(2)	GMC7.3563(1)100K33(2)
100	63	0.068	SP/K35	6.0	3.5	7.3	2824	30	F115SP683(1)100(2)	GMC7.3683(1)100K35(2)
100	63	0.082	SP/K35	6.0	3.5	7.3	2824	30	F115SP823(1)100(2)	GMC7.3823(1)100K35(2)
100	63	0.10	ST/K37	6.0	4.5	7.3	2824	30	F115ST104(1)100(2)	GMC7.3104(1)100K37(2)
100	63	0.022	WPI/A31	9.1	5.5	10.2	4036	40	F115WP223(1)100(2)	GMC10.2223(1)100A31(2)
100	63	0.027	WPI/A31	9.1	5.5	10.2	4036	40	F115WP273(1)100(2)	GMC10.2273(1)100A31(2)
100	63	0.033	WPI/A31	9.1	5.5	10.2	4036	40	F115WP333(1)100(2)	GMC10.2333(1)100A31(2)
100	63	0.039	WPI/A31	9.1	5.5	10.2	4036	40	F115WP393(1)100(2)	GMC10.2393(1)100A31(2)
100	63	0.047	WPI/A31	9.1	5.5	10.2	4036	30	F115WP473(1)100(2)	GMC10.2473(1)100A31(2)
100	63	0.056	WPI/A31	9.1	5.5	10.2	4036	30	F115WP563(1)100(2)	GMC10.2563(1)100A31(2)
100	63	0.068	WPI/A31	9.1	5.5	10.2	4036	30	F115WP683(1)100(2)	GMC10.2683(1)100A31(2)
100	63	0.082	WPI/A31	9.1	5.5	10.2	4036	30	F115WP823(1)100(2)	GMC10.2823(1)100A31(2)
100	63	0.10	WPI/A31	9.1	5.5	10.2	4036	30	F115WP104(1)100(2)	GMC10.2104(1)100A31(2)
100	63	0.12	WPI/A31	9.1	5.5	10.2	4036	30	F115WP124(1)100(2)	GMC10.2124(1)100A31(2)
100	63	0.15	WPI/A31	9.1	5.5	10.2	4036	20	F115WP154(1)100(2)	GMC10.2154(1)100A31(2)
100	63	0.18	WPI/A31	9.1	5.5	10.2	4036	20	F115WP184(1)100(2)	GMC10.2184(1)100A31(2)
VDC	VAC	Capacitance Value ( $\mu$ F)	Size Code (New/Legacy)	B (mm)	H (mm)	L (mm)	Chip Size	dV/dt (V/ $\mu$ s)	New KEMET Part Number	Legacy Part Number

(1) J =  $\pm$ 5%, K =  $\pm$ 10%, other tolerances on request.

(2) Insert ordering code for lead type and packaging. See Ordering Options Table for available options.



**Table 1 – Ratings & Part Number Reference cont'd**

VDC	VAC	Cap Value ( $\mu$ F)	Size Code (New/Legacy)	Dimensions in mm			Chip Size	dV/dt (V/ $\mu$ s)	New KEMET Part Number	Legacy Part Number
				B	H	L				
100	63	0.22	WPIA31	9.1	5.5	10.2	4036	20	F115WP224(1)100(2)	GMC10.2224(1)100A31(2)
100	63	0.27	WPIA31	9.1	5.5	10.2	4036	20	F115WP274(1)100(2)	GMC10.2274(1)100A31(2)
100	63	0.33	WPIA31	9.1	5.5	10.2	4036	20	F115WP334(1)100(2)	GMC10.2334(1)100A31(2)
100	63	0.39	YR/B31	11.5	6.5	12.7	5045	12	F115YR394(1)100(2)	GMC12.7394(1)100B31(2)
100	63	0.47	YR/B31	11.5	6.5	12.7	5045	12	F115YR474(1)100(2)	GMC12.7474(1)100B31(2)
100	63	0.56	YR/B31	11.5	6.5	12.7	5045	12	F115YR564(1)100(2)	GMC12.7564(1)100B31(2)
100	63	0.68	YR/B31	11.5	6.5	12.7	5045	12	F115YR684(1)100(2)	GMC12.7684(1)100B31(2)
100	63	0.82	ZS/C31	15.0	7.0	16.5	6560	8	F115ZS824(1)100(2)	GMC16.5824(1)100C31(2)
100	63	1.0	ZS/C31	15.0	7.0	16.5	6560	8	F115ZS105(1)100(2)	GMC16.5105(1)100C31(2)
100	63	1.2	ZS/C31	15.0	7.0	16.5	6560	8	F115ZS125(1)100(2)	GMC16.5125(1)100C31(2)
100	63	1.5	ZS/C31	15.0	7.0	16.5	6560	8	F115ZS155(1)100(2)	GMC16.5155(1)100C31(2)
100	63	1.8	ZS/C31	15.0	7.0	16.5	6560	8	F115ZS185(1)100(2)	GMC16.5185(1)100C31(2)
100	63	2.2	ZS/C31	15.0	7.0	16.5	6560	8	F115ZS225(1)100(2)	GMC16.5225(1)100C31(2)
250	160	0.0010	PP/J33	5.0	3.0	5.7	2220	40	F115PP102(1)250(2)	GMC5.7102(1)250J33(2)
250	160	0.0012	PP/J33	5.0	3.0	5.7	2220	40	F115PP122(1)250(2)	GMC5.7122(1)250J33(2)
250	160	0.0015	PP/J33	5.0	3.0	5.7	2220	40	F115PP152(1)250(2)	GMC5.7152(1)250J33(2)
250	160	0.0018	PP/J33	5.0	3.0	5.7	2220	40	F115PP182(1)250(2)	GMC5.7182(1)250J33(2)
250	160	0.0022	PP/J33	5.0	3.0	5.7	2220	40	F115PP222(1)250(2)	GMC5.7222(1)250J33(2)
250	160	0.0027	PP/J33	5.0	3.0	5.7	2220	40	F115PP272(1)250(2)	GMC5.7272(1)250J33(2)
250	160	0.0033	PP/J33	5.0	3.0	5.7	2220	40	F115PP332(1)250(2)	GMC5.7332(1)250J33(2)
250	160	0.0039	PP/J33	5.0	3.0	5.7	2220	40	F115PP392(1)250(2)	GMC5.7392(1)250J33(2)
250	160	0.0047	PP/J33	5.0	3.0	5.7	2220	40	F115PP472(1)250(2)	GMC5.7472(1)250J33(2)
250	160	0.0056	PP/J33	5.0	3.0	5.7	2220	40	F115PP562(1)250(2)	GMC5.7562(1)250J33(2)
250	160	0.0068	PP/J33	5.0	3.0	5.7	2220	40	F115PP682(1)250(2)	GMC5.7682(1)250J33(2)
250	160	0.0082	PP/J33	5.0	3.0	5.7	2220	40	F115PP822(1)250(2)	GMC5.7822(1)250J33(2)
250	160	0.010	PP/J33	5.0	3.0	5.7	2220	40	F115PP103(1)250(2)	GMC5.7103(1)250J33(2)
250	160	0.012	PP/J33	5.0	3.0	5.7	2220	40	F115PP123(1)250(2)	GMC5.7123(1)250J33(2)
250	160	0.015	PP/J33	5.0	3.0	5.7	2220	40	F115PP153(1)250(2)	GMC5.7153(1)250J33(2)
250	160	0.018	PP/J33	5.0	3.0	5.7	2220	40	F115PP183(1)250(2)	GMC5.7183(1)250J33(2)
250	160	0.022	PU/J35	5.0	4.0	5.7	2220	40	F115PU223(1)250(2)	GMC5.7223(1)250J35(2)
250	160	0.0010	SL/K33	6.0	3.0	7.3	2824	50	F115SL102(1)250(2)	GMC7.3102(1)250K33(2)
250	160	0.0012	SL/K33	6.0	3.0	7.3	2824	50	F115SL122(1)250(2)	GMC7.3122(1)250K33(2)
250	160	0.0015	SL/K33	6.0	3.0	7.3	2824	50	F115SL152(1)250(2)	GMC7.3152(1)250K33(2)
250	160	0.0018	SL/K33	6.0	3.0	7.3	2824	50	F115SL182(1)250(2)	GMC7.3182(1)250K33(2)
250	160	0.0022	SL/K33	6.0	3.0	7.3	2824	50	F115SL222(1)250(2)	GMC7.3222(1)250K33(2)
250	160	0.0027	SL/K33	6.0	3.0	7.3	2824	50	F115SL272(1)250(2)	GMC7.3272(1)250K33(2)
250	160	0.0033	SL/K33	6.0	3.0	7.3	2824	50	F115SL332(1)250(2)	GMC7.3332(1)250K33(2)
250	160	0.0039	SL/K33	6.0	3.0	7.3	2824	50	F115SL392(1)250(2)	GMC7.3392(1)250K33(2)
250	160	0.0047	SL/K33	6.0	3.0	7.3	2824	50	F115SL472(1)250(2)	GMC7.3472(1)250K33(2)
250	160	0.0056	SL/K33	6.0	3.0	7.3	2824	50	F115SL562(1)250(2)	GMC7.3562(1)250K33(2)
250	160	0.0068	SL/K33	6.0	3.0	7.3	2824	40	F115SL682(1)250(2)	GMC7.3682(1)250K33(2)
250	160	0.0082	SL/K33	6.0	3.0	7.3	2824	40	F115SL822(1)250(2)	GMC7.3822(1)250K33(2)
250	160	0.010	SL/K33	6.0	3.0	7.3	2824	40	F115SL103(1)250(2)	GMC7.3103(1)250K33(2)
250	160	0.012	SL/K33	6.0	3.0	7.3	2824	40	F115SL123(1)250(2)	GMC7.3123(1)250K33(2)
250	160	0.015	SL/K33	6.0	3.0	7.3	2824	40	F115SL153(1)250(2)	GMC7.3153(1)250K33(2)
250	160	0.018	SL/K33	6.0	3.0	7.3	2824	40	F115SL183(1)250(2)	GMC7.3183(1)250K33(2)
250	160	0.022	SL/K33	6.0	3.0	7.3	2824	40	F115SL223(1)250(2)	GMC7.3223(1)250K33(2)
250	160	0.027	SP/K35	6.0	3.5	7.3	2824	40	F115SP273(1)250(2)	GMC7.3273(1)250K35(2)
250	160	0.033	ST/K37	6.0	4.5	7.3	2824	30	F115ST333(1)250(2)	GMC7.3333(1)250K37(2)
250	160	0.039	ST/K37	6.0	4.5	7.3	2824	30	F115ST393(1)250(2)	GMC7.3393(1)250K37(2)
250	160	0.022	WPIA31	9.1	5.5	10.2	4036	40	F115WP223(1)250(2)	GMC10.2223(1)250A31(2)
250	160	0.027	WPIA31	9.1	5.5	10.2	4036	40	F115WP273(1)250(2)	GMC10.2273(1)250A31(2)
250	160	0.033	WPIA31	9.1	5.5	10.2	4036	40	F115WP333(1)250(2)	GMC10.2333(1)250A31(2)
250	160	0.039	WPIA31	9.1	5.5	10.2	4036	40	F115WP393(1)250(2)	GMC10.2393(1)250A31(2)
250	160	0.047	WPIA31	9.1	5.5	10.2	4036	30	F115WP473(1)250(2)	GMC10.2473(1)250A31(2)
250	160	0.056	WPIA31	9.1	5.5	10.2	4036	30	F115WP563(1)250(2)	GMC10.2563(1)250A31(2)
250	160	0.068	WPIA31	9.1	5.5	10.2	4036	30	F115WP683(1)250(2)	GMC10.2683(1)250A31(2)
250	160	0.082	WPIA31	9.1	5.5	10.2	4036	30	F115WP823(1)250(2)	GMC10.2823(1)250A31(2)
250	160	0.10	WPIA31	9.1	5.5	10.2	4036	30	F115WP104(1)250(2)	GMC10.2104(1)250A31(2)
VDC	VAC	Capacitance Value ( $\mu$ F)	Size Code (New/Legacy)	B (mm)	H (mm)	L (mm)	Chip Size	dV/dt (V/ $\mu$ s)	New KEMET Part Number	Legacy Part Number

(1) J =  $\pm$ 5%, K =  $\pm$ 10%, other tolerances on request.

(2) Insert ordering code for lead type and packaging. See Ordering Options Table for available options.



**Table 1 – Ratings & Part Number Reference cont'd**

VDC	VAC	Cap Value ( $\mu$ F)	Size Code (New/Legacy)	Dimensions in mm			Chip Size	dV/dt (V/ $\mu$ s)	New KEMET Part Number	Legacy Part Number
				B	H	L				
250	160	0.12	WPI/A31	9.1	5.5	10.2	4036	30	F115WP124(1)250(2)	GMC10.2124(1)250A31(2)
250	160	0.15	WPI/A31	9.1	5.5	10.2	4036	30	F115WP154(1)250(2)	GMC10.2154(1)250A31(2)
250	160	0.18	YR/B31	11.5	6.5	12.7	5045	20	F115YR184(1)250(2)	GMC12.7184(1)250B31(2)
250	160	0.22	YR/B31	11.5	6.5	12.7	5045	20	F115YR224(1)250(2)	GMC12.7224(1)250B31(2)
250	160	0.27	YR/B31	11.5	6.5	12.7	5045	20	F115YR274(1)250(2)	GMC12.7274(1)250B31(2)
250	160	0.33	YR/B31	11.5	6.5	12.7	5045	20	F115YR334(1)250(2)	GMC12.7334(1)250B31(2)
250	160	0.39	ZS/C31	15.0	7.0	16.5	6560	12	F115ZS394(1)250(2)	GMC16.5394(1)250C31(2)
250	160	0.47	ZS/C31	15.0	7.0	16.5	6560	12	F115ZS474(1)250(2)	GMC16.5474(1)250C31(2)
250	160	0.56	ZS/C31	15.0	7.0	16.5	6560	12	F115ZS564(1)250(2)	GMC16.5564(1)250C31(2)
250	160	0.68	ZS/C31	15.0	7.0	16.5	6560	12	F115ZS684(1)250(2)	GMC16.5684(1)250C31(2)
400	200	0.0010	SL/K33	6.0	3.0	7.3	2824	50	F115SL102(1)400(2)	GMC7.3102(1)400K33(2)
400	200	0.0012	SL/K33	6.0	3.0	7.3	2824	50	F115SL122(1)400(2)	GMC7.3122(1)400K33(2)
400	200	0.0015	SL/K33	6.0	3.0	7.3	2824	50	F115SL152(1)400(2)	GMC7.3152(1)400K33(2)
400	200	0.0018	SL/K33	6.0	3.0	7.3	2824	50	F115SL182(1)400(2)	GMC7.3182(1)400K33(2)
400	200	0.0022	SL/K33	6.0	3.0	7.3	2824	50	F115SL222(1)400(2)	GMC7.3222(1)400K33(2)
400	200	0.0027	SL/K33	6.0	3.0	7.3	2824	50	F115SL272(1)400(2)	GMC7.3272(1)400K33(2)
400	200	0.0033	SL/K33	6.0	3.0	7.3	2824	50	F115SL332(1)400(2)	GMC7.3332(1)400K33(2)
400	200	0.0039	SL/K33	6.0	3.0	7.3	2824	50	F115SL392(1)400(2)	GMC7.3392(1)400K33(2)
400	200	0.0047	SL/K33	6.0	3.0	7.3	2824	50	F115SL472(1)400(2)	GMC7.3472(1)400K33(2)
400	200	0.0056	SL/K33	6.0	3.0	7.3	2824	50	F115SL562(1)400(2)	GMC7.3562(1)400K33(2)
400	200	0.0068	SL/K33	6.0	3.0	7.3	2824	50	F115SL682(1)400(2)	GMC7.3682(1)400K33(2)
400	200	0.0082	SP/K35	6.0	3.5	7.3	2824	50	F115SP822(1)400(2)	GMC7.3822(1)400K35(2)
400	200	0.010	SP/K35	6.0	3.5	7.3	2824	50	F115SP103(1)400(2)	GMC7.3103(1)400K35(2)
400	200	0.012	SP/K35	6.0	3.5	7.3	2824	50	F115SP123(1)400(2)	GMC7.3123(1)400K35(2)
400	200	0.015	ST/K37	6.0	4.5	7.3	2824	50	F115ST153(1)400(2)	GMC7.3153(1)400K37(2)
400	200	0.022	WPI/A31	9.1	5.5	10.2	4036	40	F115WP223(1)400(2)	GMC10.2223(1)400A31(2)
400	200	0.027	WPI/A31	9.1	5.5	10.2	4036	40	F115WP273(1)400(2)	GMC10.2273(1)400A31(2)
400	200	0.033	WPI/A31	9.1	5.5	10.2	4036	40	F115WP333(1)400(2)	GMC10.2333(1)400A31(2)
400	200	0.039	WPI/A31	9.1	5.5	10.2	4036	40	F115WP393(1)400(2)	GMC10.2393(1)400A31(2)
400	200	0.047	WPI/A31	9.1	5.5	10.2	4036	40	F115WP473(1)400(2)	GMC10.2473(1)400A31(2)
400	200	0.056	YR/B31	11.5	6.5	12.7	5045	30	F115YR563(1)400(2)	GMC12.7563(1)400B31(2)
400	200	0.068	YR/B31	11.5	6.5	12.7	5045	30	F115YR683(1)400(2)	GMC12.7683(1)400B31(2)
400	200	0.082	YR/B31	11.5	6.5	12.7	5045	30	F115YR823(1)400(2)	GMC12.7823(1)400B31(2)
400	200	0.10	YR/B31	11.5	6.5	12.7	5045	30	F115YR104(1)400(2)	GMC12.7104(1)400B31(2)
400	200	0.12	ZS/C31	15.0	7.0	16.5	6560	20	F115ZS124(1)400(2)	GMC16.5124(1)400C31(2)
400	200	0.15	ZS/C31	15.0	7.0	16.5	6560	20	F115ZS154(1)400(2)	GMC16.5154(1)400C31(2)
400	200	0.18	ZS/C31	15.0	7.0	16.5	6560	20	F115ZS184(1)400(2)	GMC16.5184(1)400C31(2)
400	200	0.22	ZS/C31	15.0	7.0	16.5	6560	20	F115ZS224(1)400(2)	GMC16.5224(1)400C31(2)
400	200	0.27	ZS/C31	15.0	7.0	16.5	6560	20	F115ZS274(1)400(2)	GMC16.5274(1)400C31(2)
400	200	0.33	ZS/C31	15.0	7.0	16.5	6560	20	F115ZS334(1)400(2)	GMC16.5334(1)400C31(2)
630	300	0.022	WPI/A31	9.1	5.5	10.2	4036	40	F115WP223(1)630(2)	GMC10.2223(1)630A31(2)
630	300	0.027	YR/B31	11.5	6.5	12.7	5045	30	F115YR273(1)630(2)	GMC12.7273(1)630B31(2)
630	300	0.033	YR/B31	11.5	6.5	12.7	5045	30	F115YR333(1)630(2)	GMC12.7333(1)630B31(2)
630	300	0.039	YR/B31	11.5	6.5	12.7	5045	30	F115YR393(1)630(2)	GMC12.7393(1)630B31(2)
630	300	0.047	YR/B31	11.5	6.5	12.7	5045	30	F115YR473(1)630(2)	GMC12.7473(1)630B31(2)
630	300	0.056	YR/B31	11.5	6.5	12.7	5045	30	F115YR563(1)630(2)	GMC12.7563(1)630B31(2)
630	300	0.068	ZS/C31	15.0	7.0	16.5	6560	20	F115ZS683(1)630(2)	GMC16.5683(1)630C31(2)
630	300	0.082	ZS/C31	15.0	7.0	16.5	6560	20	F115ZS823(1)630(2)	GMC16.5823(1)630C31(2)
630	300	0.10	ZS/C31	15.0	7.0	16.5	6560	20	F115ZS104(1)630(2)	GMC16.5104(1)630C31(2)
630	300	0.12	ZS/C31	15.0	7.0	16.5	6560	20	F115ZS124(1)630(2)	GMC16.5124(1)630C31(2)
630	300	0.15	ZS/C31	15.0	7.0	16.5	6560	20	F115ZS154(1)630(2)	GMC16.5154(1)630C31(2)
VDC	VAC	Capacitance Value ( $\mu$ F)	Size Code (New/Legacy)	B (mm)	H (mm)	L (mm)	Chip Size	dV/dt (V/ $\mu$ s)	New KEMET Part Number	Legacy Part Number

(1) J =  $\pm$ 5%, K =  $\pm$ 10%, other tolerances on request.

(2) Insert ordering code for lead type and packaging. See Ordering Options Table for available options.

## Soldering Process

Reflow soldering temperature is measured on the top surface of the component. Preheating temperature should be less than 170°C. The time above 217°C should be less than 50 seconds. The peak temperature must not exceed 250°C.

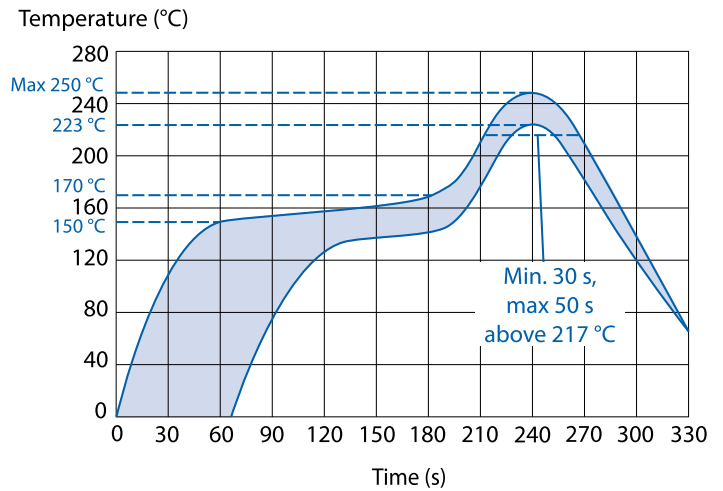

## Marking

- Capacitance
- Capacitance tolerance code
- Rated voltage code
- Capacitor type G for GMC
- Manufacturing date code

Rated Voltage	Code
50 VDC	Z
63 VDC	C
100 VDC	D
250 VDC	H
400 VDC	K
630 VDC	M

Manufacturing Date Code (IEC 60062)			
Y = Year, Z = Month			
Year	Code	Month	Code
2000	M	January	1
2001	N	February	2
2002	P	March	3
2003	R	April	4
2004	S	May	5
2005	T	June	6
2006	U	July	7
2007	V	August	8
2008	W	September	9
2009	X	October	O
2010	A	November	N
2011	B	December	D
2012	C		
2013	D		
2014	E		
2015	F		
2016	H		
2017	J		
2018	K		
2019	L		
2020	M		

## Flux & Cleaning

KEMET recommends to use a no-clean flux with a halogen content lower than 0.1%.

To clean the PCB assembly KEMET recommends to use a suitable solvent like Isopropyl alcohol, deionized water or neutral pH detergents. Aggressive solvents shall not be used. For any different cleaning solvent used please contact KEMET Technical Services to analyze the potential impact on KEMET products.

## Storage and Moisture Recommendations

KEMET SMD Film Capacitors are supplied in a MBB (Moisture Barrier Bag) Class 1. We can guarantee a 24 months shelf life (temperature  $\leq 40^{\circ}\text{C}$ /relative humidity  $\leq 90\%$ ). After the MBB has been opened, components may stay in areas with controlled temperature and humidity (temperature  $\leq 30^{\circ}\text{C}$ /relative humidity  $\leq 60\%$ ) for 168 hours [MSL 3]. For longer periods of time and/or higher temperature and/or higher relative humidity values, it is absolutely necessary to protect the components against humidity. If the reel inside the MBB is partially used, KEMET recommends to re-use the same MBB or to avoid areas without controlled temperature and humidity (see above). If the above conditions are not respected, components require a baking (minimum time: 48 hours at  $55 \pm 5^{\circ}\text{C}$ ) before the reflow.

## Packaging Quantities

Chip Size (EIA)	Base (mm)	Height (mm)	Length (mm)	Bulk	Reel Horizontal Orientation	Reel Vertical Orientation
2220	5	3	5.7	2000	2400	
2220	5	4	5.7	2000	2100	
2824	6	3	7.3	2000	2500	
2824	6	3.5	7.3	2000	2300	
2824	6	4.5	7.3	1000	1700	
4036	9.1	5.5	10.2	1000	800	500
5045	11.5	6.5	12.7	1000	600	400
6560	15	7	16.5	800	500	200

## Landing

Mounting	Chip Size	Dimensions in mm		
		A	B	X
Horizontal	2220	5.1	1.5	3.0
	2824	6.1	1.5	3.8
	4036	9.1	2.0	5.5
	5045	11.6	2.5	7.0
	6560	15.0	3.0	9.0
Vertical	4022	5.6	2.0	5.5
	5026	6.6	2.5	7.0
	6528	7.1	3.0	9.0

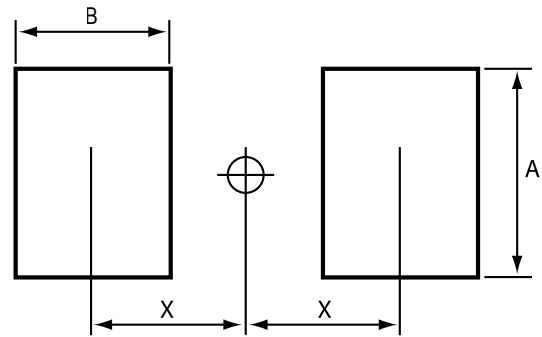

## Carrier Taping & Packaging (IEC 60286-2)

### Horizontal Taping Orientation

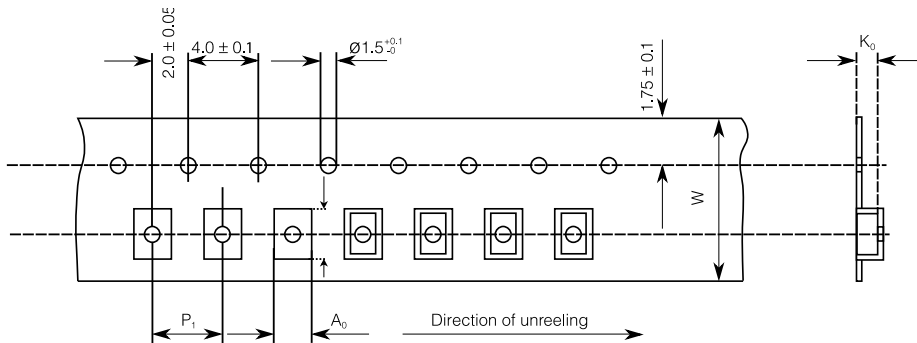

Chip Size (EIA) Horizontal Mounting	Dimensions in mm			Taping Specification							
	B	H	L	W	P <sub>1</sub>	A <sub>0</sub>	B <sub>0</sub>	K <sub>0</sub>	D	W <sub>1</sub>	W <sub>2</sub>
	Nominal	Nominal	Nominal	-0/+0.3	+/-0.1	Nominal	Nominal	Nominal	-/+2.0	-0/+2	Maximum
2220	5.0	3.0	5.7	12.0	8.0	5.5	6.0	3.3	330	12.4	22.0
2220	5.0	4.0	5.7	12.0	8.0	5.5	6.0	4.3	330	12.4	22.0
2824	6.0	3.0	7.3	12.0	8.0	6.5	7.5	3.3	330	12.4	22.0
2824	6.0	3.5	7.3	12.0	8.0	6.5	7.5	3.8	330	12.4	22.0
2824	6.0	4.5	7.3	16.0	8.0	6.6	7.9	5.5	330	16.0	20.0
4036	9.1	5.5	10.2	16.0	16.0	9.5	10.5	5.8	330	16.4	22.0
5045	11.5	6.5	12.7	24.0	16.0	11.9	13.1	6.8	330	24.4	30.0
6560	15.0	7.0	16.5	24.0	20.0	15.4	16.8	7.3	330	24.4	30.0

## Carrier Taping & Packaging (IEC 60286–2) cont'd

### Vertical Taping Orientation

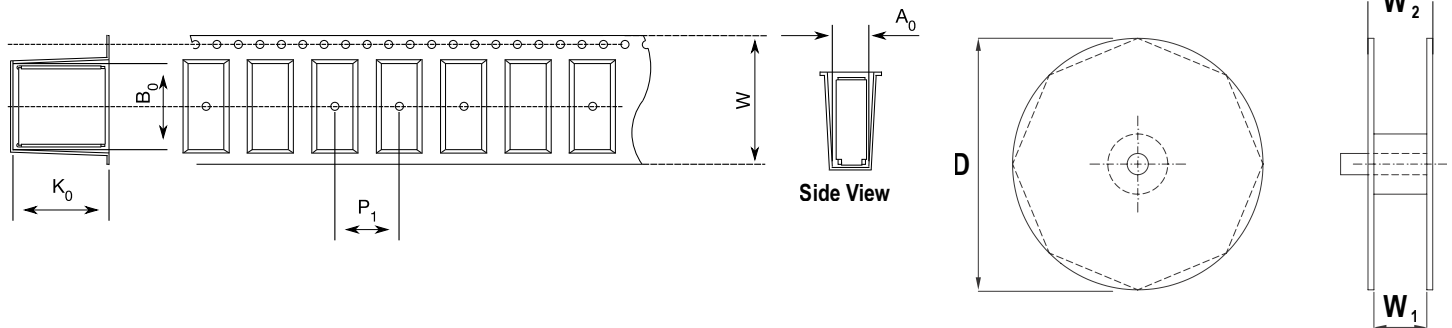

Size Code Vertical Mounting	Dimensions in mm			Taping Specification							
	B	H	L	W	$P_1$	$A_0$	$B_0$	$K_0$	D	$W_1$	$W_2$
	Nominal	Nominal	Nominal	-0/+0.3	+/-0.1	Nominal	Nominal	Nominal	-/+2.0	-0/+2	Maximum
4022	5.5	9.1	10.2	24.0	16.0	6.0	10.5	9.3	330	24.4	30.0
5026	6.5	11.5	12.7	24.0	16.0	6.9	13.1	11.8	330	24.4	30.0
6528	7.0	15.0	16.5	44.0	20.0	7.5	17.0	15.3	330	44.5	49.5

**Note:** Chip dimensions B and H correspond to dimensions H and B in the horizontal mounting table.

## KEMET Corporation World Headquarters

2835 KEMET Way  
Simpsonville, SC 29681

Mailing Address:  
P.O. Box 5928  
Greenville, SC 29606

www.kemet.com  
Tel: 864-963-6300  
Fax: 864-963-6521

**Corporate Offices**  
Fort Lauderdale, FL  
Tel: 954-766-2800

## North America

### Northeast

Wilmington, MA  
Tel: 978-658-1663

### Southeast

Lake Mary, FL  
Tel: 407-855-8886

### Central

Novi, MI  
Tel: 248-994-1030

Irving, TX  
Tel: 972-915-6041

### West

Milpitas, CA  
Tel: 408-433-9950

### Mexico

Guadalajara, Jalisco  
Tel: 52-33-3123-2141

## Europe

### Southern Europe

Sasso Marconi, Italy  
Tel: 39-051-939111

Skopje, Macedonia  
Tel: 389-2-55-14-623

### Central Europe

Landsberg, Germany  
Tel: 49-8191-3350800

Kamen, Germany  
Tel: 49-2307-438110

### Northern Europe

Wyboston, United Kingdom  
Tel: 44-1480-273082

Espoo, Finland  
Tel: 358-9-5406-5000

## Asia

### Northeast Asia

Hong Kong  
Tel: 852-2305-1168

Shenzhen, China  
Tel: 86-755-2518-1306

Beijing, China  
Tel: 86-10-5877-1075

Shanghai, China  
Tel: 86-21-6447-0707

Seoul, South Korea  
Tel: 82-2-6294-0550

Taipei, Taiwan  
Tel: 886-2-27528585

### Southeast Asia

Singapore  
Tel: 65-6701-8033

Penang, Malaysia  
Tel: 60-4-6430200

Bangalore, India  
Tel: 91-806-53-76817

*Note: KEMET reserves the right to modify minor details of internal and external construction at any time in the interest of product improvement. KEMET does not assume any responsibility for infringement that might result from the use of KEMET Capacitors in potential circuit designs. KEMET is a registered trademark of KEMET Electronics Corporation.*



## Disclaimer

All product specifications, statements, information and data (collectively, the "Information") in this datasheet are subject to change. The customer is responsible for checking and verifying the extent to which the Information contained in this publication is applicable to an order at the time the order is placed.

All Information given herein is believed to be accurate and reliable, but it is presented without guarantee, warranty, or responsibility of any kind, expressed or implied.

Statements of suitability for certain applications are based on KEMET Electronics Corporation's ("KEMET") knowledge of typical operating conditions for such applications, but are not intended to constitute – and KEMET specifically disclaims – any warranty concerning suitability for a specific customer application or use. The Information is intended for use only by customers who have the requisite experience and capability to determine the correct products for their application. Any technical advice inferred from this Information or otherwise provided by KEMET with reference to the use of KEMET's products is given gratis, and KEMET assumes no obligation or liability for the advice given or results obtained.

Although KEMET designs and manufactures its products to the most stringent quality and safety standards, given the current state of the art, isolated component failures may still occur. Accordingly, customer applications which require a high degree of reliability or safety should employ suitable designs or other safeguards (such as installation of protective circuitry or redundancies) in order to ensure that the failure of an electrical component does not result in a risk of personal injury or property damage.

Although all product-related warnings, cautions and notes must be observed, the customer should not assume that all safety measures are indicated or that other measures may not be required.