

EAUVA35352

1.8W Series

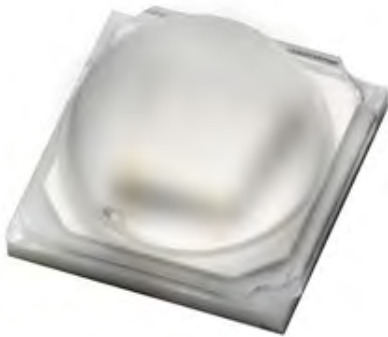

Introduction

The EAUVA35352 product series is a ceramic based LED with high quality and reliability that suitable for UV application.

Features

- ◆ High power UVA LED
- ◆ Dimension 3.5mm* 3.5mm* 2.35mm
- ◆ ESD protection up to 8KV
- ◆ RoHS compliant
- ◆ Pb free
- ◆ EU REACH compliant
- ◆ Halogen Free compliant
(Br<900ppm,Cl<900ppm,Br+Cl<1500ppm)

Applications

- ◆ UV Sterilization System
- ◆ UV Photo-catalyst
- ◆ UV Sensor Light

Table of Contents

Table of Contents	2
Absolute Maximum Ratings	3
Electro-Optical Characteristic.....	4
Bin Range of Luminous Flux	5
Bin Range of Forward Voltage	5
Bin Range of Peak Wavelength	5
PN of the EAUVA35352 series: UVA LEDs	6
Mechanical Dimension	7
Pad Configuration	8
Typical Characteristics Curves.....	9
Forward Current V.S. Peak Wavelength	9
Forward Current vs. Relative Radiant Flux	10
Forward Voltage vs. Forward Current	10
Ambient Temp vs. Peak Wavelength.....	11
Ambient Temp vs. Relative Radiant Flux.....	11
Ambient Temp vs. Forward Voltage	12
Derating Curve.....	12
Typical Radiation Patterns	13
Emitter Tape Packaging.....	14
Emitter Reel Packaging	15
Product Labeling	15
Storage Conditions	16
Revision History	17

Absolute Maximum Ratings

Parameter	Symbol	Ratings	Unit
Max. DC Forward Current (mA)	I_F	700 ^[1]	mA
Max. Peak Pulse Current (mA)	I_{Pulse}	1000 ^[2]	mA
Power Dissipation	P_d	3	W
Max. ESD Resistance	V_B	8000	V
Thermal Resistance	R_{th}	5 ^[4]	K/W
Max. Junction Temperature	T_J	125 ^[5]	°C
Operating Temperature	T_{Opr}	-40 ~ +110	°C
Storage Temperature	T_{Stg}	-40 ~ +110	°C

Notes:

1. Maximum forward current is 700mA (Thermal Pad=25°C).
2. Duty cycle = 1/10@1KHZ
3. The EAUVA35352 series LEDs are not designed for reverse bias use.
4. Thermal Resistance is from junction to backside of component.
5. Maximum junction temperature of UV is 125°C.

EVERLIGHT

Electro-Optical Characteristic

Parameter	Symbol	Min.	Typ.	Max	Unit	Condition
Radiant Flux	Φ_e	700	---	---	mW	IF=500mA
Forward Voltage	VF	3.4	---	4	V	
Peak Wavelength	λ_p	---	368	---	nm	
Viewing Angle	$2\theta_{1/2}$	---	120	----	deg	

Parameter	Symbol	Min.	Typ.	Max	Unit	Condition
Radiant Flux	Φ_e	900	---	---	mW	IF=500mA
Forward Voltage	VF	3.2	---	3.8	V	
Peak Wavelength	λ_p	---	385	---	nm	
Viewing Angle	$2\theta_{1/2}$	---	120	----	deg	

Parameter	Symbol	Min.	Typ.	Max	Unit	Condition
Radiant Flux	Φ_e	900	---	---	mW	IF=500mA
Forward Voltage	VF	3	---	3.6	V	
Peak Wavelength	λ_p	---	395	400	nm	
Viewing Angle	$2\theta_{1/2}$	---	120	----	deg	

Parameter	Symbol	Min.	Typ.	Max	Unit	Condition
Radiant Flux	Φ_e	900	---	---	mW	IF=500mA
Forward Voltage	VF	3	---	3.6	V	
Peak Wavelength	λ_p	---	405	---	nm	
Viewing Angle	$2\theta_{1/2}$	---	120	----	deg	

Notes:

1. Radiant flux measurement tolerance: $\pm 10\%$.
2. The data of luminous flux measured at thermal pad=25°C
3. Typical radiant flux or light output performance is operated within the condition guided by this datasheet.

Bin Range of Luminous Flux

Bin Code	Min.	Max	Unit	Condition
R5	700	800	mW	IF=500mA
R6	800	900		
R7	900	1000		
R8	1000	1300		

Notes: Radiant flux measurement tolerance: $\pm 10\%$.

Bin Range of Forward Voltage

Group	Bin	Bin Code	Min.	Max	Unit	Condition
C	V1+V2+V3	V1	2.95	3.25	V	IF=500mA
D	V2+V3+V4	V2	3.25	3.55		
E	V3+V4+V5	V3	3.55	3.85		
F	V1+V2	V4	3.85	4.15		

Notes: Tolerance of Forward Voltage: $\pm 0.1V$.

Bin Range of Peak Wavelength

Group	Bin	Min.	Max	Unit	Condition
P UVA	1	360	365	nm	IF=500mA
	2	365	370		
	3	370	375		
	4	375	380		
	5	380	385		
	6	385	390		
	7	390	395		
	8	395	400		
	9	400	405		
	0	405	410		

PN of the EAUVA35352 series: UVA LEDs

The table below is a list of part numbers for the Everlight EAUVA35352 1.8W series UVA LED. Typical view angle is 120°. These clearly listed binning options allow for proper design and implementation into UV applications. The Order Codes below are currently available UVA EAUVA35352 LEDs.

For Example: If you order product using P/N : EAUVA35352BC5 , you will be specifying:

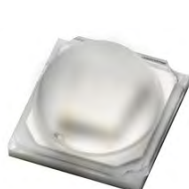

Color	Typ. Peak Wavelength (nm)	Forward Voltage (V)	Minimum Radiant Flux (mW)
UV	368	3.6	700

UV, EAUVA35352 series LEDs at 500mA are listed below

Color	Order Code of EAUVA35352	Minimum Radiant Flux (mW)	Peak Wavelength (nm)	Forward Voltage (V)
Ultraviolet	EAUVA35352BC5	700	365~375	3.25-4.15
	EAUVA35352BC6	800	365~375	3.25-4.15
	EAUVA35352EF7	900	380~390	2.95-3.85
	EAUVA35352EF8	1000	380~390	2.95-3.85
	EAUVA35352GH7	900	390~400	2.95-3.85
	EAUVA35352GH8	1000	390~400	2.95-3.85
	EAUVA35352IJ7	900	400~410	2.95-3.85
	EAUVA35352IJ8	1000	400~410	2.95-3.85

Mechanical Dimension

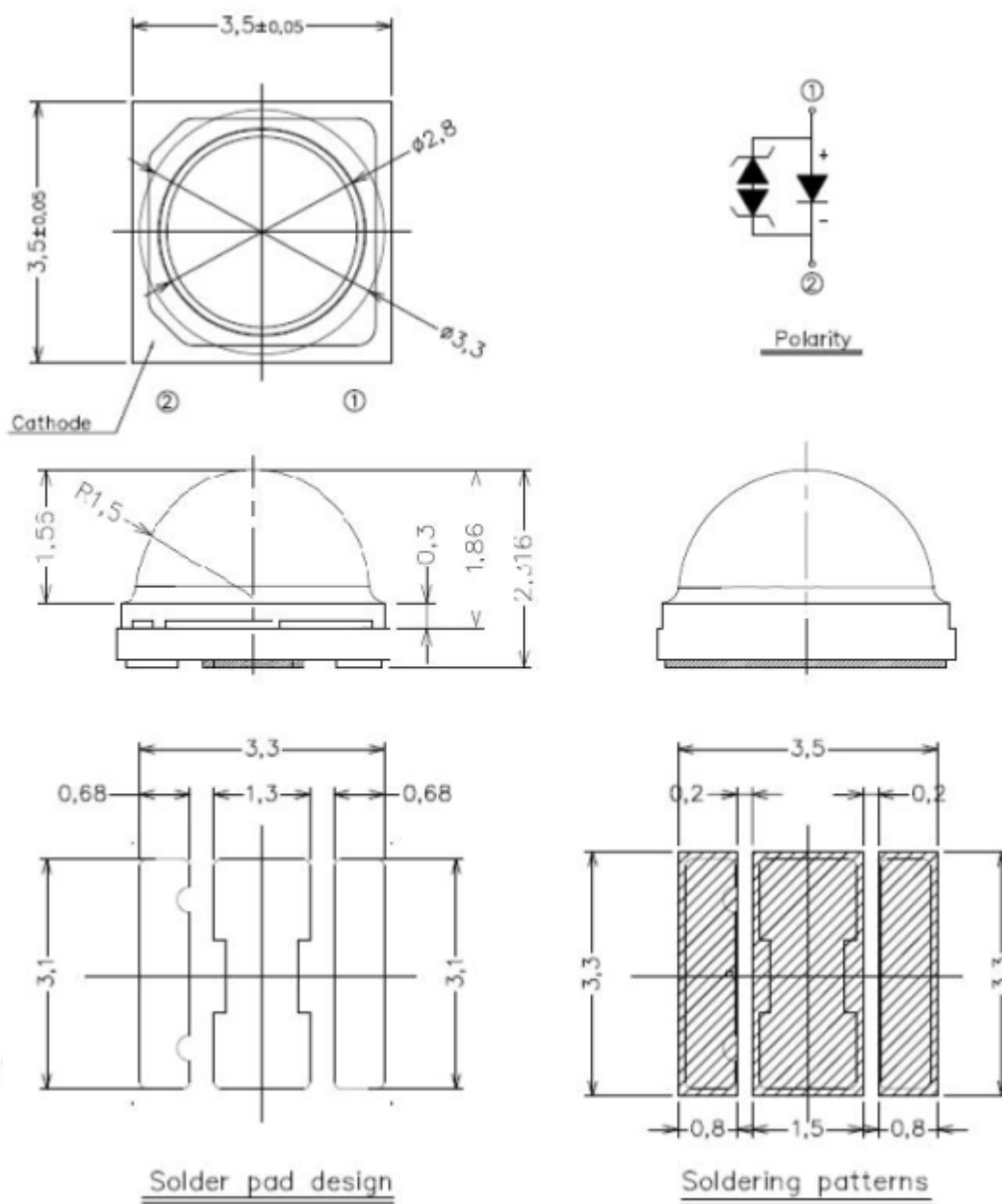

1. Dimensions are in millimeters.
2. Tolerances unless mentioned are ± 0.1 mm

Pad Configuration

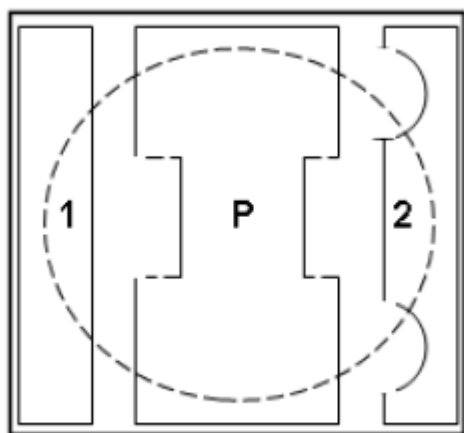

BOTTOM VIEW

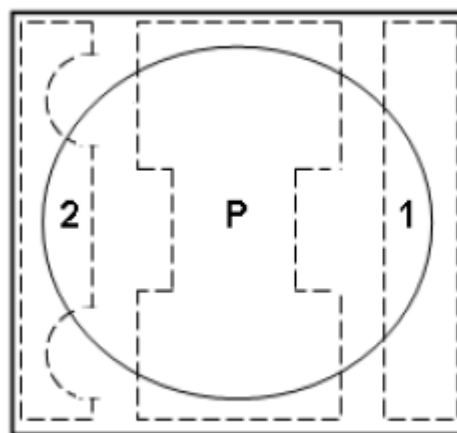

TOP VIEW

PAD	FUNCTION
1	ANODE
2	CATHODE
P	THERMAL PAD

EVERLIGHT

Typical Characteristics Curves Spectrum @ Thermal Pad Temperature = 25°C

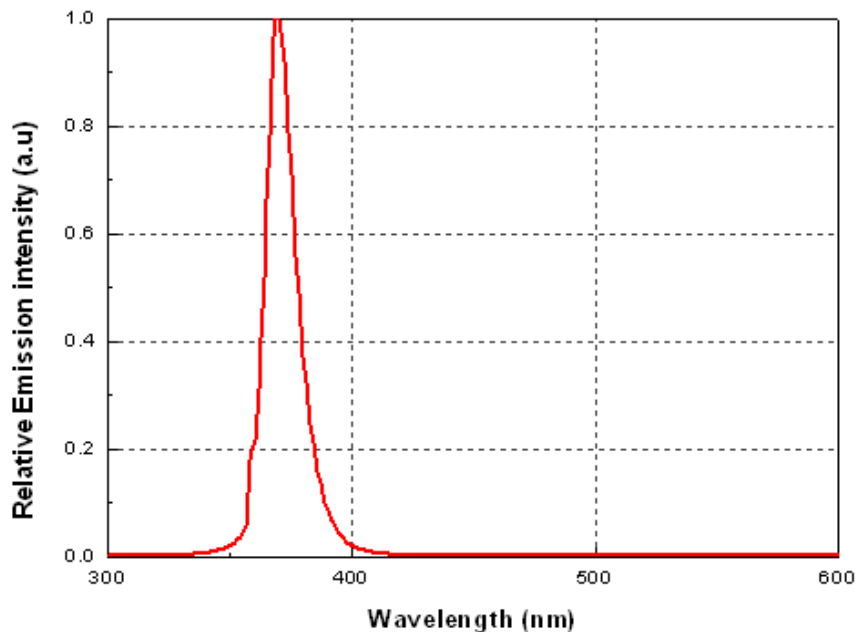

Forward Current V.S. Peak Wavelength @ Thermal Pad Temperature = 25°C

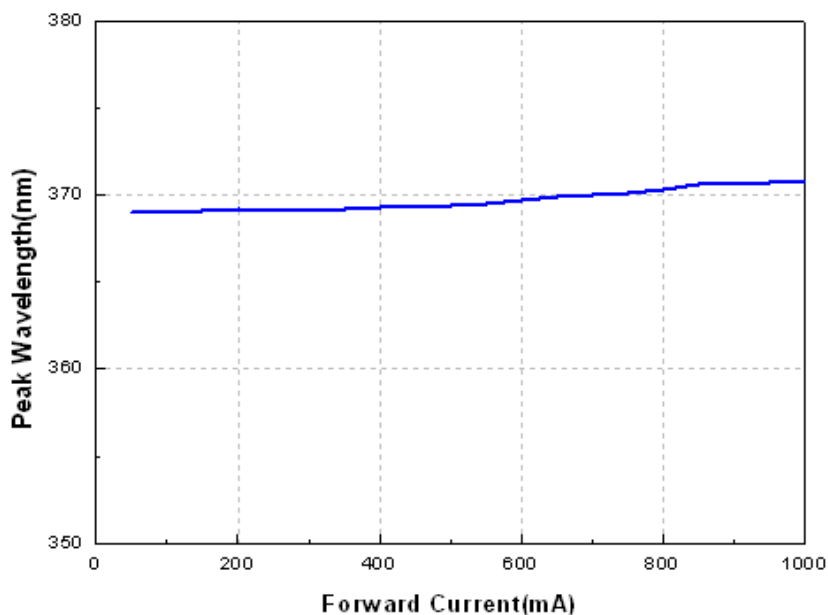

Forward Current vs. Relative Radiant Flux @ Thermal Pad Temperature = 25°C

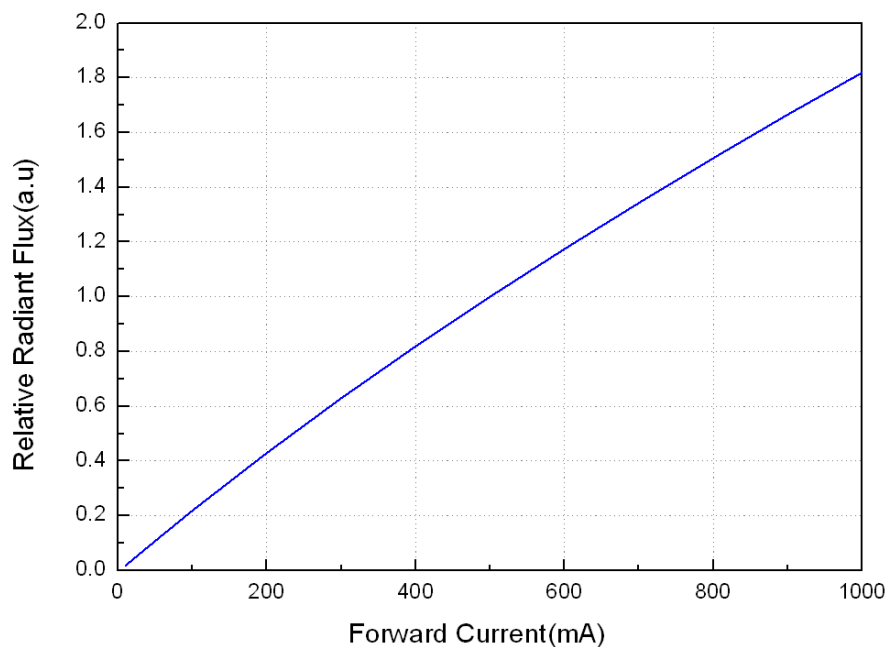

Forward Voltage vs. Forward Current @ Thermal Pad Temperature = 25°C

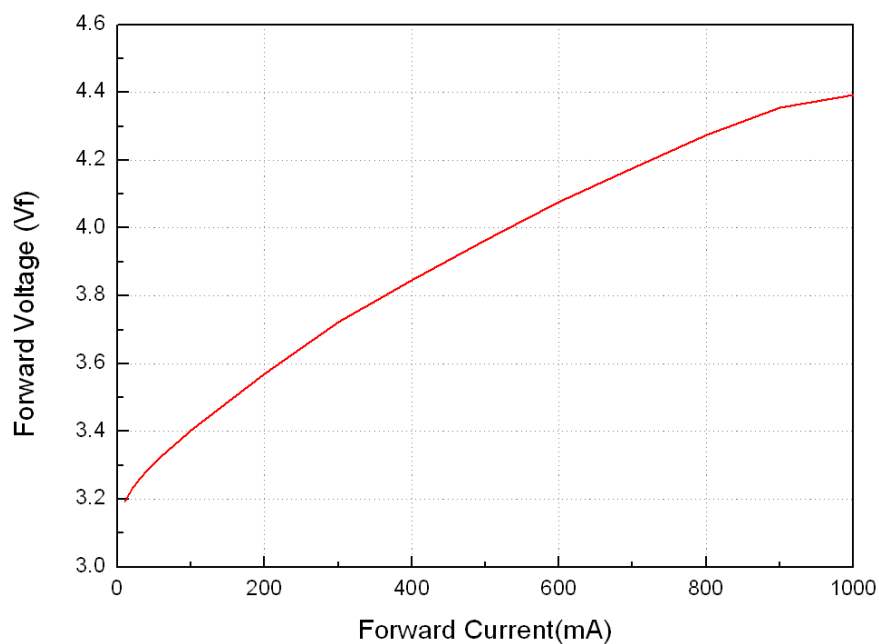

Ambient Temp vs. Peak Wavelength

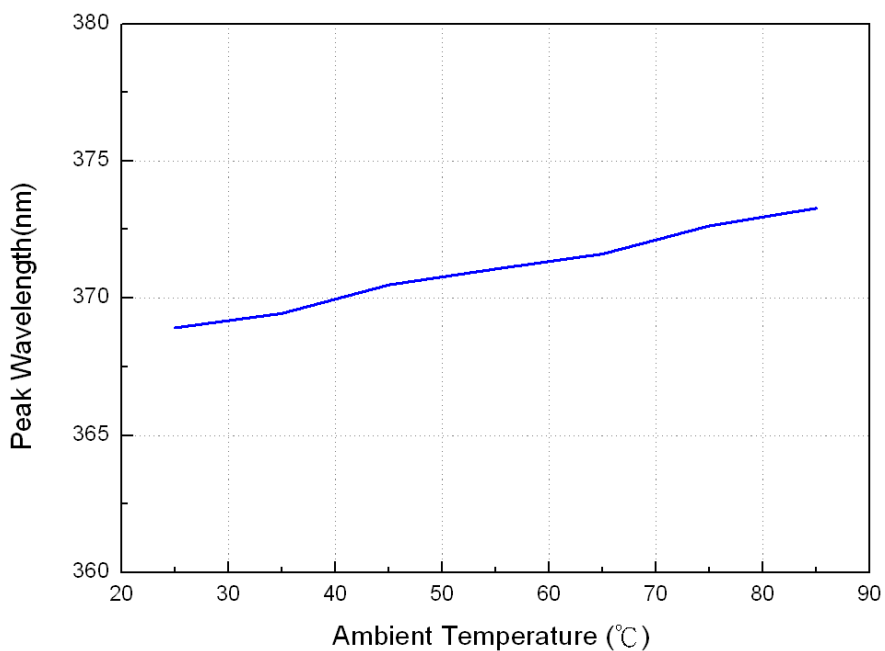

Ambient Temp vs. Relative Radiant Flux

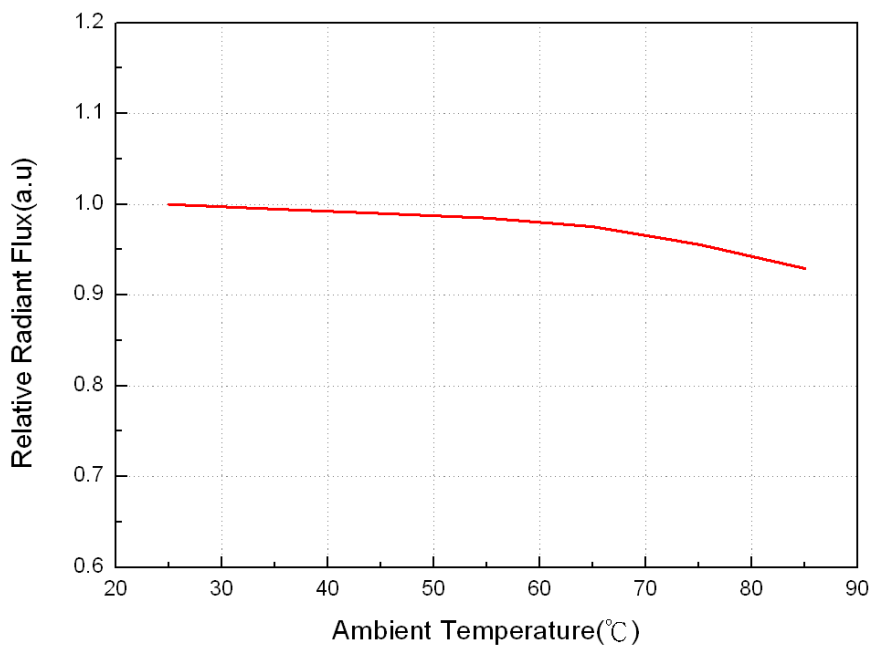

Ambient Temp vs. Forward Voltage

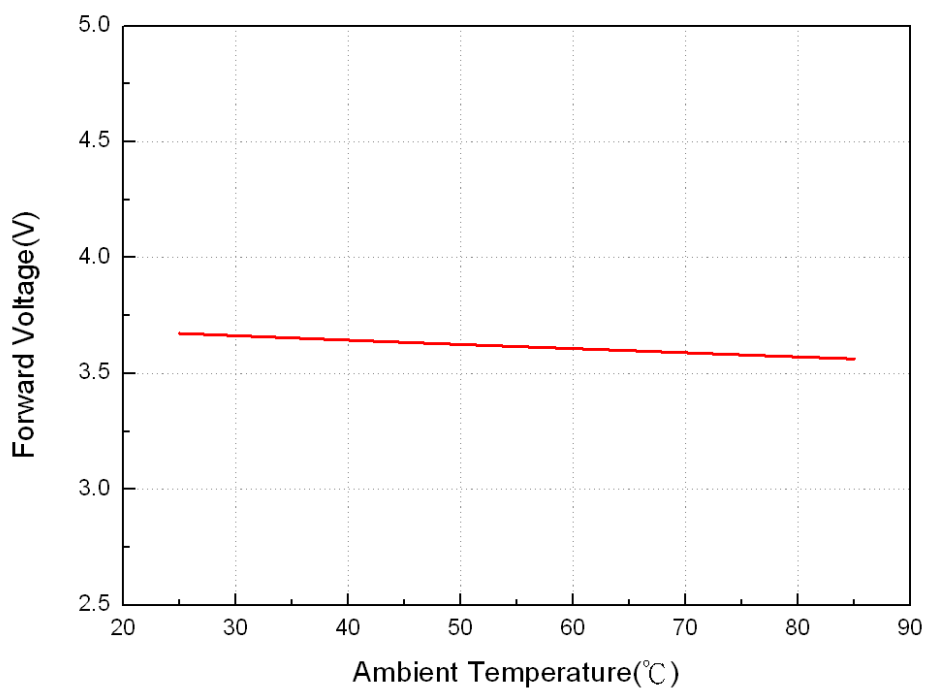

Derating Curve

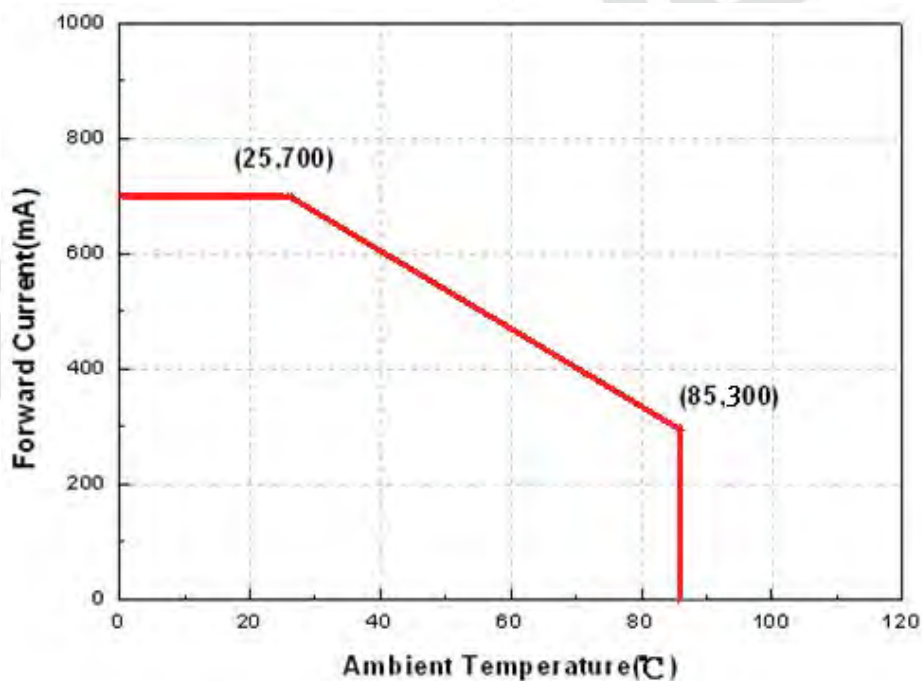

Typical Radiation Patterns

Typical Diagram Characteristics of Radiation for EAUVA35352

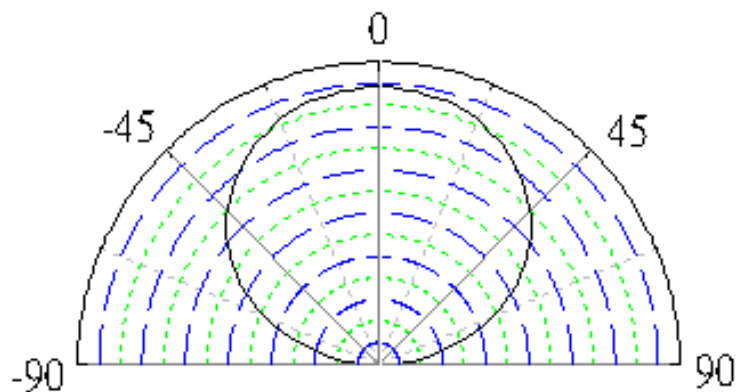

Notes:

1. $2\theta_{1/2}$ is the off axis angle from lamp centerline where the luminous intensity is 1/2 of the peak value.
2. View angle tolerance is $\pm 5^\circ$.

EVERLIGHT

Emitter Tape Packaging

Carrier Tape Dimensions as the following:

Reel: 2000pcs

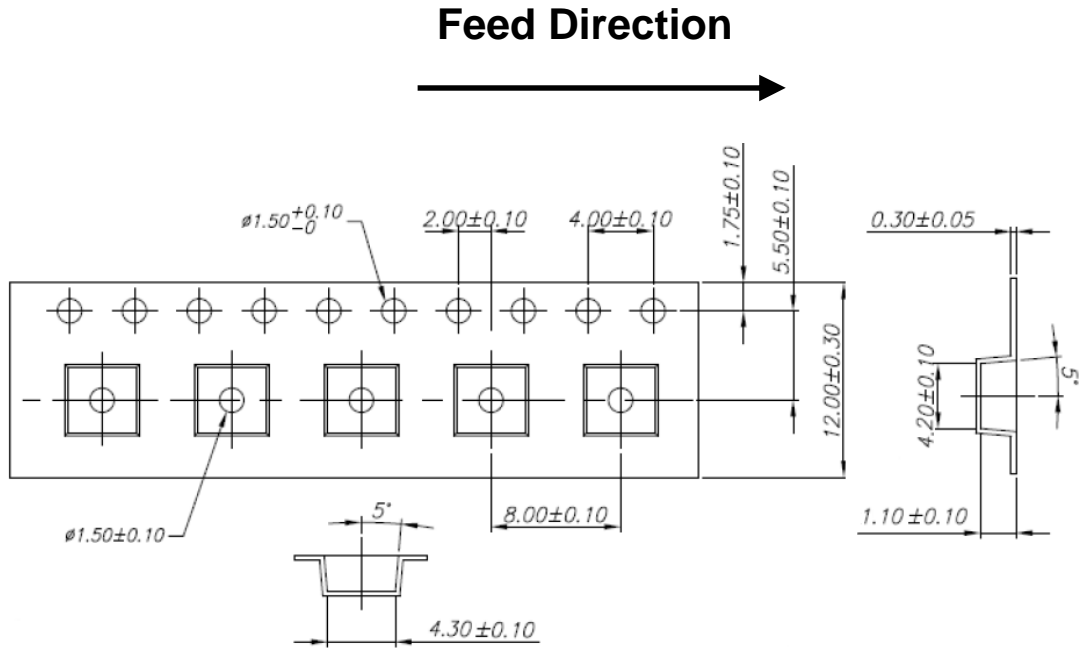

Notes:

1. Tolerance unless mentioned is ± 0.1 mm; Unit = mm
2. Minimum packing amount is 250/500/1000/2000 pcs per reel

Moisture Resistant Packaging

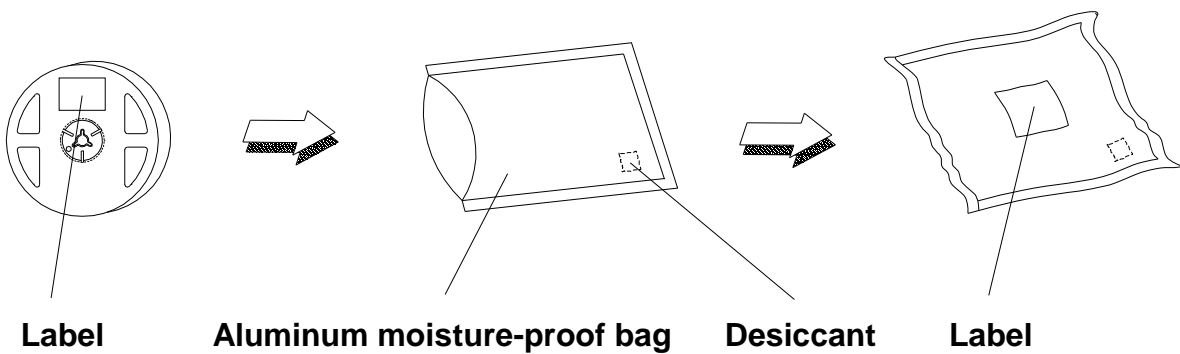

Emitter Reel Packaging

Reel Dimensions

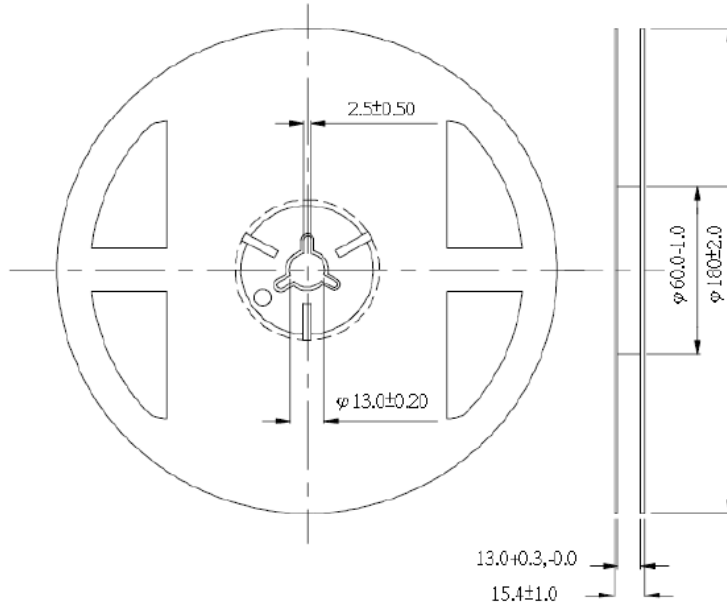

Notes:

1. Dimensions are in millimeters.
2. Tolerances unless mentioned are $\pm 0.1\text{mm}$.

Product Labeling

Label Explanation

- CPN: Customer Specification (when required)
- P/N : Everlight Production Number
- QTY: Packing Quantity
- CAT: Luminous Flux (Brightness) Bin
- HUE: Color Bin
- REF: Forward Voltage Bin
- LOT No: Lot Number
- MADE IN TAIWAN: Production Place

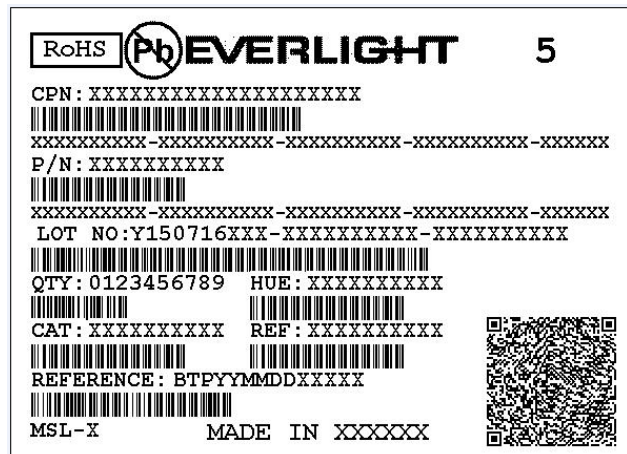

Storage Conditions

- Before the package is opened :The LEDs should be stored at 30°C or less and 85%RH or less after being shipped from Everlight and the storage life limits are 1 year. The LEDs can be stored up to 3 years if in a sealed container with a nitrogen atmosphere and moisture absorbent material.
- After opening the package: The LED's floor life is 168hrs when environment is 30°C or less and 60%RH or less. The LED should be soldered within 168hrs (7days) after opening the package. If unused LEDs remain, it should be stored in moisture proof packages.
- If the moisture absorbent material (silica gel) has faded away or the LEDs have exceeded the storage time, baking treatment should be performed using the following conditions. Baking treatment: 60±5°C for 24 hours.

EVERLIGHT

Revision History

Current version: **2016/5/24**

Previous version: **N/A**

Device No.

Rev. Ver. 1

Page	Subjects (major change in previous version)	Date of change

EVERLIGHT