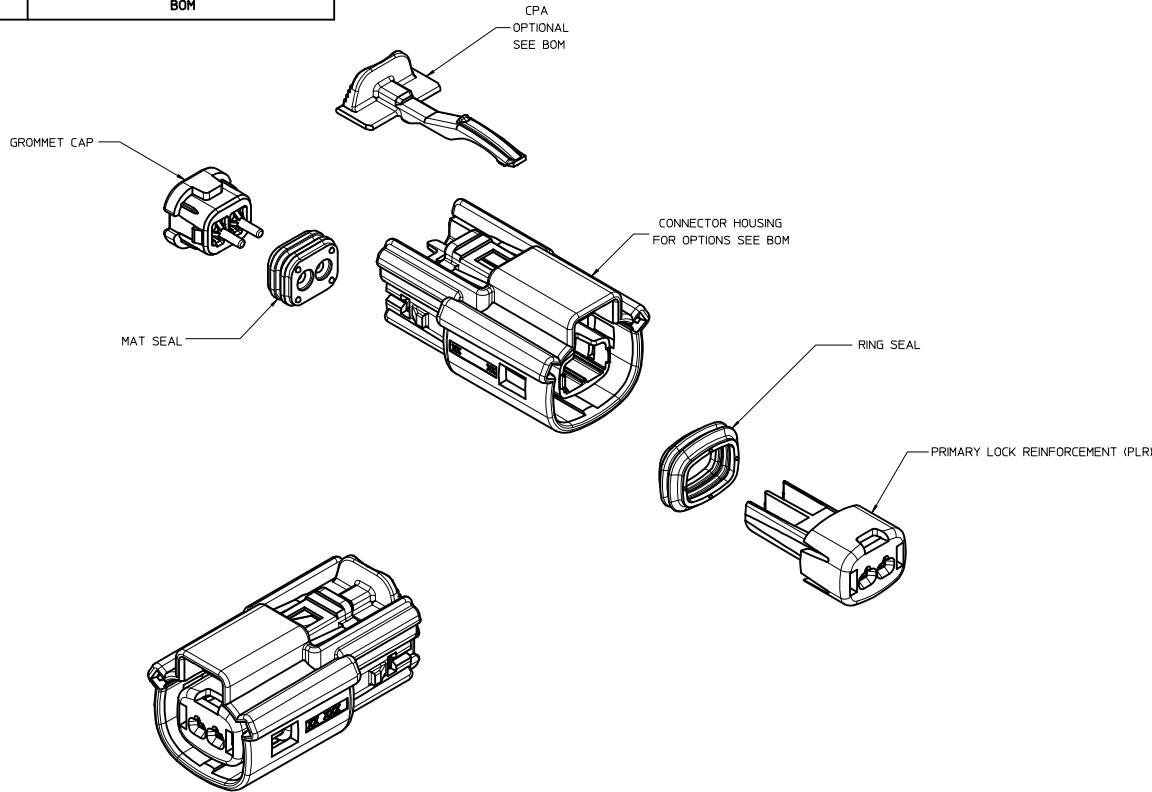

TABLE OF CONTENTS	
SHEET NO.	SHEET DESCRIPTION
1	NOTES
2	KEY CONFIGURATIONS
3	RECEPTACLE SEALED ASSEMBLY
4	BACKSHELL NOTES
5	BACKSHELL
6	BACKSHELL CONFIGURATIONS
7	BOM



NOTES: VALID UNLESS OTHERWISE SPECIFIED

1. GENERAL:
 - a. APPLICATION SPECIFICATION SEE: AS-33472-100
 - CONTAINS: PRODUCT INTRODUCTION, PRODUCT SUMMARY, CONNECTOR ASSEMBLY, PACKAGING INFORMATION, CONNECTOR MATING SERVICE INSTRUCTIONS, ELECTRICAL CONTINUITY CHECKING, CRIMPING AND TROUBLESHOOTING.
 - DESIGNED TO MATE WITH DEVICE CONNECTION AS SPECIFIED IN DRAWING EWCAP 150-5-002-1-Z05, AVAILABLE AT <http://ewcap.uscarteams.org/>.
 - DESIGNED TO MATE WITH BLADE SEALED ASSEMBLY AS SPECIFIED IN DRAWING SD-33481-021
 - FOR 15mm RECEPTACLE TERMINALS TO BE USED WITH THIS ASSEMBLY. SEE MOLEX DRAWING SD-33012-002.
 - SYSTEM TO BE USED WITH WIRE WITHIN DIAMETER RANGE OF 1.2 mm TO 2.69 mm.
 - ASSEMBLY SHIPPED WITH PLR AND CPA IN PRE-LOCK POSITION (SEE SECTION Z-Z PRE-LOCK).
 - IN THE EVENT THAT THE PLR IS FOUND IN THE SEATED (FINAL LOCK) POSITION, REFER TO MOLEX SPECIFICATION PS-34646-001, AVAILABLE AT www.molex.com <http://www.molex.com>.
 - ASSEMBLY CONFORMS TO SAE/USCAR-2 REV.4 WITH THE FOLLOWING EXCEPTIONS: ENGAGEMENT FORCE TO MOVE CPA FROM PRE-LOCK TO FINAL LOCK POSITION WHEN UNMATED: 40N MIN. DISENGAGEMENT FORCE TO MOVE CPA FROM FINAL LOCK TO PRE-LOCK POSITION: 3N MIN. 40N MAX. TERMINAL INSERTION FORCE FOR WIRE DIAMETER ABOVE 2.5mm NOT EXCEEDING 2.69mm SHALL NOT EXCEED 40 NEWTONS.
 - b. PRODUCT SPECIFICATION SEE: PS-33471-000
 - CONTAINS: PRODUCT INTRODUCTION, PRODUCT SUMMARY, RATINGS (CURRENT, TEMPERATURE, SEALING, AND FLAMMABILITY), AND PRODUCT VALIDATION.
 - c. PACKAGING SPECIFICATION PER MOLEX DRAWING PK-31300-635
 - d. PARTS MUST BE IN COMPLIANCE TO MOLEX CHEMICAL SUBSTANCES FOR PRODUCTS AND PACKAGING SPECIFICATION: ES-40000-5016
 - e. DATA MUST BE SUBMITTED UNDER THE MOLEX PART NUMBER TO IMDS (COMPANY ID#13255)
2. DESIGN - MATERIALS:
 - a. SEE BOM TABLE
3. DESIGN - GEOMETRY:
 - a. THIS IS A 100% CAD GENERATED PART. THE CAD MATHEMATICAL DATA IS THE MASTER FOR THIS PART. FOR DIMENSIONAL OR ANY INFORMATION NOT SHOWN ON THIS DRAWING, ANALYZE THE CAD MODEL.
 - b. GEOMETRIC DIMENSIONS AND TOLERANCES PER ASME Y14.5M - 1994
 - c. EDGES AND UNDIMENSIONED DETAILS PER ISO13715
 - d. CORNERS SHOWN AS SHARP TO BE 0.2 MAX.
 - e. LETTERING SHALL BE 0.15 MAX RAISED IN 0.25 MAX RECESS PAD. THIS INCLUDES RECYCLING CODE, CAVITY ID, VENDOR IDENTIFICATION, AND CUSTOMER MATERIAL NUMBER.
 - f. VISUAL DEFECTS SHALL MEET COSMETIC STANDARD PS-45499-002 (Class B)
 - g. LASER MARKING: TBD

INSPECTION NUMBER LOG
 LAST NUMBER USED: 5
 ADDED:
 REMOVED:

C11	ADD NEW P/N 33471-0224
C10	ADD NEW P/N 33471-0223
C9	UPDATED VIEWSET & NOTES
C8	RENAMED BACKSHELLS
C7	UPDATED CONFIGURATIONS SHEET 3
C6	UPDATED PACKAGING SPECIFICATION
C5	UPDATED GROMMET CAP CALLOUT
C4	REDRAWN, ADDED BACKSHELL
REV	DESCRIPTION

ENTER DESCRIPTION ELEC NO: UAU2014-1876 DRAWN BY: 2014/06/06 CHKD: APPR: VKOSHY 2014/06/19 C11	QUALITY SYMBOLS ∇=0 ∇=0 ∇=0	GENERAL TOLERANCES (UNLESS SPECIFIED) <table border="1"> <thead> <tr> <th></th> <th>mm</th> <th>INCH</th> </tr> </thead> <tbody> <tr> <td>4 PLACES</td> <td>+0.15</td> <td>+0.006</td> </tr> <tr> <td>3 PLACES</td> <td>+0.10</td> <td>+0.004</td> </tr> <tr> <td>2 PLACES</td> <td>+0.075</td> <td>+0.003</td> </tr> <tr> <td>1 PLACE</td> <td>+0.05</td> <td>+0.002</td> </tr> <tr> <td>0 PLACE</td> <td>+0.025</td> <td>+0.001</td> </tr> </tbody> </table> ANGULAR ± 3 ° DRAFT WHERE APPLICABLE MUST REMAIN WITHIN DIMENSIONS		mm	INCH	4 PLACES	+0.15	+0.006	3 PLACES	+0.10	+0.004	2 PLACES	+0.075	+0.003	1 PLACE	+0.05	+0.002	0 PLACE	+0.025	+0.001	DIMENSION STYLE MM ONLY DRAWN BY: SVERZYL DATE: 06/17/08 CHECKED BY: DGRIFITHS DATE: 06/18/08 APPROVED BY: VKOSHY DATE: 2010/11/04	SCALE: 3:1 DESIGN UNITS: METRIC THIRD ANGLE PROJECTION	TITLE: MX150 1X2 RECEPTACLE SEALED ASSEMBLY MAT SEAL molex MATERIAL NO. SEE BOM DOCUMENT NO. SD-33471-021 SHEET NO. 1 OF 7
		mm	INCH																				
	4 PLACES	+0.15	+0.006																				
	3 PLACES	+0.10	+0.004																				
2 PLACES	+0.075	+0.003																					
1 PLACE	+0.05	+0.002																					
0 PLACE	+0.025	+0.001																					
THIS DRAWING CONTAINS INFORMATION THAT IS PROPRIETARY TO MOLEX INCORPORATED AND SHOULD NOT BE USED WITHOUT WRITTEN PERMISSION																							
INSPECTION NUMBER LOG LAST NUMBER USED: 5 ADDED: REMOVED:																							
ADD NEW P/N 33471-0224 ADD NEW P/N 33471-0223 UPDATED VIEWSET & NOTES RENAMED BACKSHELLS UPDATED CONFIGURATIONS SHEET 3 UPDATED PACKAGING SPECIFICATION UPDATED GROMMET CAP CALLOUT REDRAWN, ADDED BACKSHELL																							

KEY CONFIGURATIONS

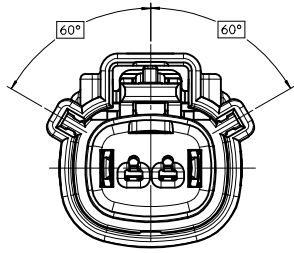

KEY A

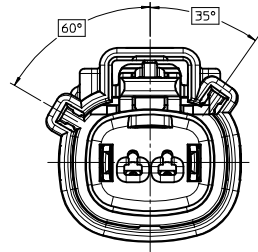

KEY B

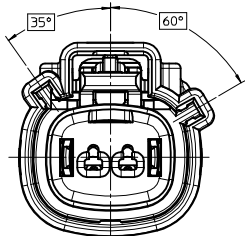

KEY C

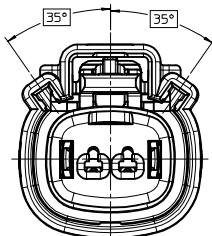

KEY D

ENTER DESCRIPTION IEC NO: UAU2014-4876 DRAWN BY: 2014/06/06 CHKD: VKOSHY APPR: VKOSHY 2014/06/19 REVISIONS C11	QUALITY SYMBOLS ▽=0 ▽=0 ▽=0	GENERAL TOLERANCES (UNLESS SPECIFIED) mm INCH 4 PLACES ± --- ± --- 3 PLACES ± --- ± --- 2 PLACES ± 0.10 ± --- 1 PLACE ± 0.2 ± --- 0 PLACE ± --- ± --- ANGULAR ± 3 ° DRAFT WHERE APPLICABLE MUST REMAIN WITHIN DIMENSIONS	DIMENSION STYLE MM ONLY DRAWN BY: SVERZYL DATE: 06/17/08 CHECKED BY: DGRIFITHS DATE: 06/18/08 APPROVED BY: VKOSHY DATE: 2010/11/04 MATERIAL NO: SEE BOM SIZE: D	SCALE: 4:1 DESIGN UNITS: METRIC THIRD ANGLE PROJECTION	TITLE: MX150 1X2 RECEPTACLE SEALED ASSEMBLY MAT SEAL molex DOCUMENT NO: SD-33471-021	SHEET NO: 2 OF 7
	THIS DRAWING CONTAINS INFORMATION THAT IS PROPRIETARY TO MOLEX INCORPORATED AND SHOULD NOT BE USED WITHOUT WRITTEN PERMISSION					
	THIS DRAWING CONTAINS INFORMATION THAT IS PROPRIETARY TO MOLEX INCORPORATED AND SHOULD NOT BE USED WITHOUT WRITTEN PERMISSION					
	THIS DRAWING CONTAINS INFORMATION THAT IS PROPRIETARY TO MOLEX INCORPORATED AND SHOULD NOT BE USED WITHOUT WRITTEN PERMISSION					

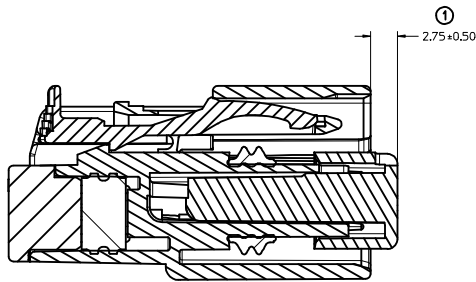
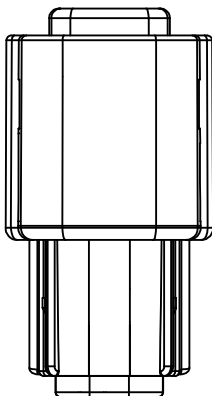
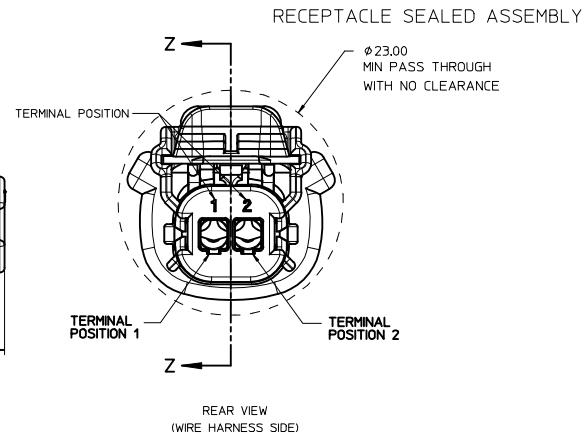
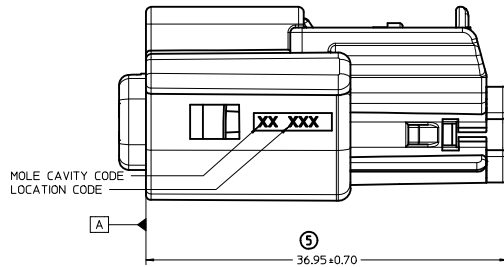
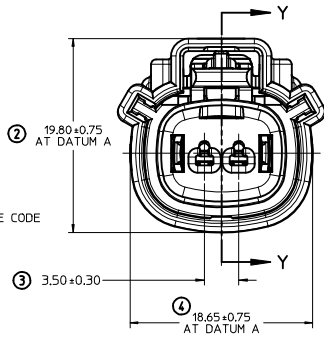
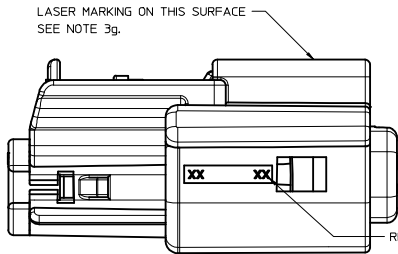

PRIMARY LOCK REINFORCEMENT (PLR) SHOWN
IN PRE-STAGED POSITION

SECTION Z-Z

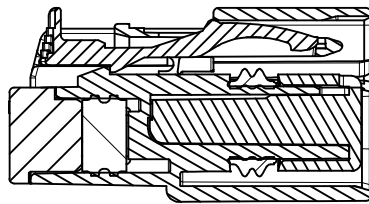

PRIMARY LOCK REINFORCEMENT (PLR) SHOWN
IN FINAL-LOCK POSITION

SECTION Y-Y

ENTER DESCRIPTION IEC NO: UAU2014-1876 DRAWN BY: 2014/06/06 CHKD: APPR: VKOSHY 2014/06/19 C11	QUALITY SYMBOLS ∇=0 ∇=0 ∇=0	GENERAL TOLERANCES (UNLESS SPECIFIED) mm INCH 4 PLACES ± --- ± --- 3 PLACES ± --- ± --- 2 PLACES ± 0.10 ± --- 1 PLACE ± 0.2 ± --- 0 PLACE ± --- ± --- ANGULAR ± 3 ° DRAFT WHERE APPLICABLE MUST REMAIN WITHIN DIMENSIONS	DIMENSION STYLE MM ONLY DRAWN BY: DATE SVERZYL 06/17/08 CHECKED BY: DATE DGRIFITHS 06/18/08 APPROVED BY: DATE VKOSHY 2010/11/04	SCALE 4:1 DESIGN UNITS METRIC THIRD ANGLE PROJECTION	TITLE MX150 1X2 RECEPTACLE SEALED ASSEMBLY MAT SEAL molex	MATERIAL NO. SEE BOM	DOCUMENT NO. SD-33471-021	SHEET NO. 3 OF 7
	THIS DRAWING CONTAINS INFORMATION THAT IS PROPRIETARY TO MOLEX INCORPORATED AND SHOULD NOT BE USED WITHOUT WRITTEN PERMISSION							
	SIZE D							
	REVISIONS							

BACKSHELL NOTES

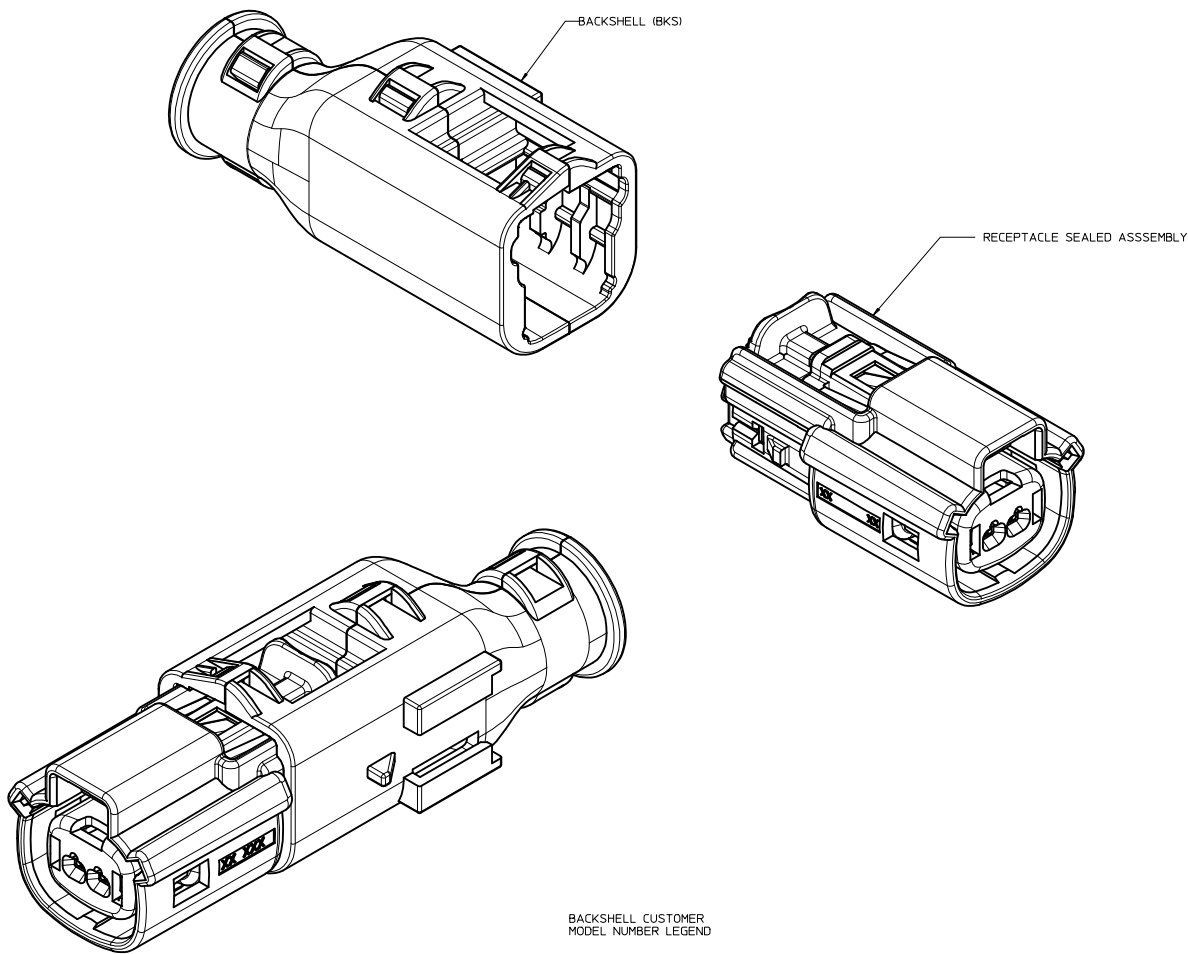

BACKSHELL NOTES: VALID UNLESS OTHERWISE SPECIFIED

1. GENERAL:

- a. APPLICATION SPECIFICATION SEE: AS-34951-001
- DESIGNED TO MATE WITH RECEPTACLE SEALED ASSEMBLY SPECIFIED IN MOLEX DRAWING SD-33471-021.
- SYSTEM TO BE USED WITH WIRE WITHIN DIAMETER RANGE OF 1.2mm TO 2.69mm.
- COMPONENTS ARE OPTIONAL AND MUST BE PURCHASED SEPARATELY.
- BACKSHELL DESIGN IS OWNED BY SCHLEMMER.
- FOR ADDITIONAL INFORMATION SEE THE BACKSHELL COMPONENT DRAWING SD-34949-0001.

BACKSHELL CUSTOMER MODEL NUMBER LEGEND

34949-XXXX

- CUSTOMER MODEL COMPONENTS
 - 0 - BACKSHELL ONLY
 - 1 - BACKSHELL & MX150 HOUSING KEY A ASSEMBLY
 - 2 - BACKSHELL & MX150 HOUSING KEY B ASSEMBLY
 - 3 - BACKSHELL & MX150 HOUSING KEY C ASSEMBLY
 - 4 - BACKSHELL & MX150 HOUSING KEY D ASSEMBLY
- BACKSHELL FEATURES
 - 1 - WITH RIBS
 - 2 - WITHOUT RIBS
- MX150 CIRCUIT SIZE 02, 03, 04, 05, 06

ENTER DESCRIPTION IEC NO. UAU2014-1876 DRAWN BY CHKD: APPR: VKOSHY 2014/06/06 2014/06/19 C11	QUALITY SYMBOLS	GENERAL TOLERANCES (UNLESS SPECIFIED)	DIMENSION STYLE	SCALE	DESIGN UNITS	THIRD ANGLE PROJECTION
	∇=0 ∇=0 ∇=0	mm INCH 4 PLACES ± --- ± --- 3 PLACES ± --- ± --- 2 PLACES ± 0.10 ± --- 1 PLACE ± 0.2 ± --- 0 PLACE ± --- ± ---	MM ONLY	4:1	METRIC	DRAWN BY DATE SVERZYL 06/17/08 CHECKED BY DATE DGRIFITHS 06/18/08 APPROVED BY DATE VKOSHY 2010/11/04
	ANGULAR ± 3 ° DRAFT WHERE APPLICABLE MUST REMAIN WITHIN DIMENSIONS	MATERIAL NO. SEE BOM	TITLE MX150 1X2 RECEPTACLE SEALED ASSEMBLY MAT SEAL molex DOCUMENT NO. SD-33471-021	SHEET NO. 4 OF 7		

BACKSHELL
 THE VIEWS ON THIS SHEET ARE
 IN THE CLOSED UN-ASSEMBLED POSITION

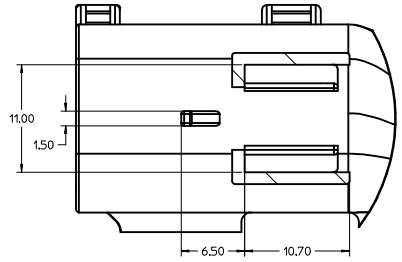
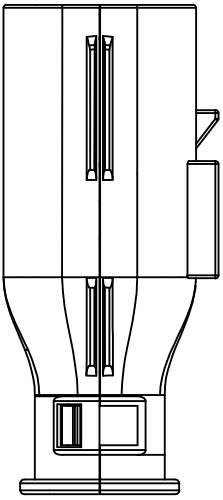
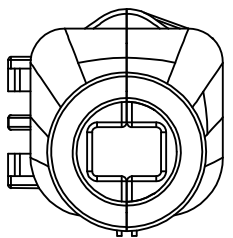
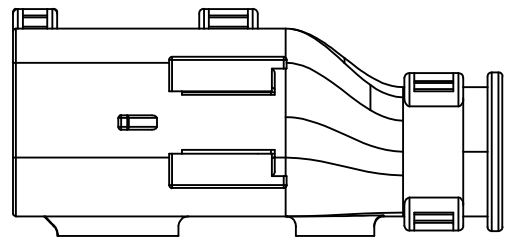
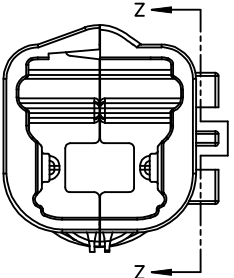
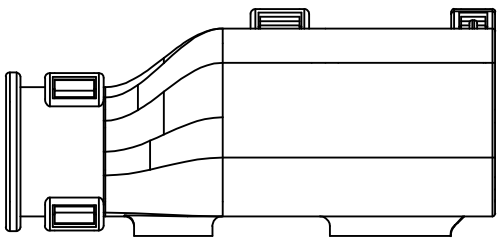

Partial Z-Z
 SCALE 4:1

ENTER DESCRIPTION IEC NO: UAU2014-4876 DRAWN BY: 2014/06/06 CHKD: VKOSHY APPR: VKOSHY 2014/06/19 DESCRIPTION	QUALITY SYMBOLS	GENERAL TOLERANCES (UNLESS SPECIFIED)	DIMENSION STYLE	SCALE	DESIGN UNITS	THIRD ANGLE PROJECTION
	$\nabla=0$ $\nabla=0$ $\nabla=0$	mm INCH 4 PLACES ± --- ± --- 3 PLACES ± --- ± --- 2 PLACES ± 0.10 ± --- 1 PLACE ± 0.2 ± --- 0 PLACE ± --- ± ---	MM ONLY	4:1	METRIC	
	DRAFT WHERE APPLICABLE MUST REMAIN WITHIN DIMENSIONS	ANGULAR ± 3° MATERIAL NO. SEE BOM DATE 06/17/08 DATE 06/18/08 DATE 2010/11/04	DRAWN BY: SVERZYL CHECKED BY: DGRIFITHS APPROVED BY: VKOSHY	TITLE: MX150 1X2 RECEPTACLE SEALED ASSEMBLY MAT SEAL molex	DOCUMENT NO. SD-33471-021	SHEET NO. 5 OF 7
	SIZE D	THIS DRAWING CONTAINS INFORMATION THAT IS PROPRIETARY TO MOLEX INCORPORATED AND SHOULD NOT BE USED WITHOUT WRITTEN PERMISSION				

20 19 18 17 16 15 14 13 12 11 10 9 8 7 6 5 4 3 2 1

BACKSHELL CONFIGURATIONS

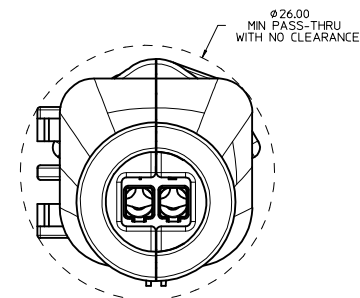
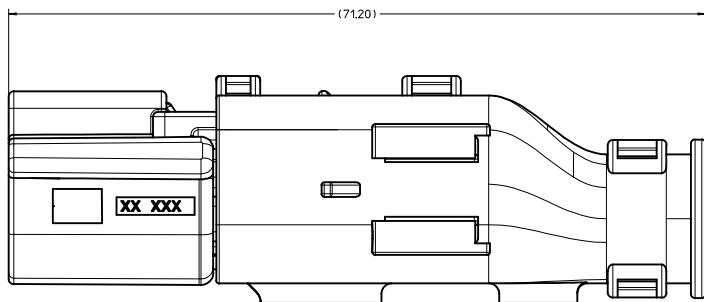

RECEPTACLE SEALED ASSEMBLY WITH RECEPTACLE BACKSHELL

ENTER DESCRIPTION IEC NO: UAU2014-4876 DRAWN BY: 2014/06/06 CHKD: VKOSHY APPR: VKOSHY 2014/06/19 REVISION DESCRIPTION C11	QUALITY SYMBOLS	GENERAL TOLERANCES (UNLESS SPECIFIED)	DIMENSION STYLE	SCALE	DESIGN UNITS	THIRD ANGLE PROJECTION
	▽=0	4 PLACES ± mm ± INCH	MM ONLY	4:1	METRIC	☉
	▽=0	3 PLACES ± 0.10	DRAWN BY: SVERZYL DATE: 06/17/08	TITLE: MX150 1X2 RECEPTACLE SEALED ASSEMBLY MAT SEAL		
	▽=0	2 PLACES ± 0.2	CHECKED BY: DGRIFITHS DATE: 06/18/08	molex		
	ANGULAR ± 3°	1 PLACE ±	APPROVED BY: VKOSHY DATE: 2010/11/04	MATERIAL NO. SEE BOM	DOCUMENT NO. SD-33471-021	SHEET NO. 6 OF 7
	DRAFT WHERE APPLICABLE MUST REMAIN WITHIN DIMENSIONS	0 PLACE ±	THIS DRAWING CONTAINS INFORMATION THAT IS PROPRIETARY TO MOLEX INCORPORATED AND SHOULD NOT BE USED WITHOUT WRITTEN PERMISSION			

19 18 17 16 15 14 13 12 11 10 9 8 7 6 5 4 3 2 1

(C11)	KEY A W/CPA, BLACK	33471-0224	A					GCP	CPA		2	SALEABLE		34949-0210	34949-0220	
	KEY A W/CPA, YELLOW	33471-0223				A	GCO		CPA			SALEABLE		34949-0210	34949-0220	
	KEY A, BLACK	33471-0222	A					GCP			2	SALEABLE		34949-0210	34949-0220	
	KEY A, BLACK	33471-0221	A					GCP		1	2	SALEABLE		34949-0210	34949-0220	
	KEY D W/CPA, STONE GRAY	33471-0217			D			GCP	CPA	1		SALEABLE		34949-0210	34949-0220	
	KEY C W/CPA, DARK GRAY	33471-0216			C			GCP	CPA	1		SALEABLE		34949-0210	34949-0220	
	KEY B W/CPA, LIGHT GRAY	33471-0215		B				GCP	CPA	1		SALEABLE		34949-0210	34949-0220	
	KEY A W/CPA, BLACK	33471-0214	A					GCP	CPA	1		SALEABLE		34949-0210	34949-0220	
	KEY D, STONE GRAY	33471-0213			D			GCP		1		SALEABLE		34949-0210	34949-0220	
	KEY C, DARK GRAY	33471-0212			C			GCP		1		SALEABLE		34949-0210	34949-0220	
	KEY B, LIGHT GRAY	33471-0211		B				GCP		1		SALEABLE		34949-0210	34949-0220	
	KEY A, BLACK	33471-0210	A					GCP		1		SALEABLE		34949-0210	34949-0220	
	KEY D W/CPA, STONE GRAY	33471-0209			D	GCO			CPA			SALEABLE		34949-0210	34949-0220	
	KEY C W/CPA, DARK GRAY	33471-0208			C	GCO			CPA			SALEABLE		34949-0210	34949-0220	
	KEY B W/CPA, LIGHT GRAY	33471-0207			B	GCO			CPA			SALEABLE		34949-0210	34949-0220	
	KEY A W/CPA, BLACK	33471-0206	A			GCO			CPA			SALEABLE		34949-0210	34949-0220	
	KEY D, STONE GRAY	33471-0204			D	GCO						SALEABLE		34949-0210	34949-0220	
	KEY C, DARK GRAY	33471-0203			C	GCO						SALEABLE		34949-0210	34949-0220	
	KEY B, LIGHT GRAY	33471-0202			B	GCO						SALEABLE		34949-0210	34949-0220	
	KEY A, BLACK	33471-0201	A			GCO						SALEABLE		34949-0210	34949-0220	
	ASSEMBLY DESCRIPTION	ASSEMBLY PART NUMBER	A	B	C	D	A	GCO	GCP	CPA	1	2	STATUS	COMMENTS	BACKSHELL WITH RIBS	BACKSHELL WITHOUT RIBS
	BLOCKED TERMINAL															
	CAVITY WITH A NUMBER INDICATES BLOCKED TERMINAL POSITION												OPTIONAL ATTACHMENTS SOLD SEPERATELY			
	CAVITY WITHOUT A NUMBER INDICATES OPEN TERMINAL POSITION															

MAT SEAL	ROYAL BLUE	INHERENTLY LUBRICATED SILICONE
RING SEAL	LIGHT BLUE	INHERENTLY LUBRICATED SILICONE
PLR	NATURAL	SPS/NYLON GF20
CPA	RED	PBT GF20
GROMMET CAP (PLUGGED)	BLACK	SPS/NYLON GF20
GROMMET CAP (OPEN)	BLACK	SPS/NYLON GF20
HOUSING KEYING OPTION A	YELLOW	SPS/NYLON GF20
HOUSING KEYING OPTION D	STONE GRAY	SPS/NYLON GF20
HOUSING KEYING OPTION C	DARK GRAY	SPS/NYLON GF20
HOUSING KEYING OPTION B	LIGHT GRAY	SPS/NYLON GF20
HOUSING KEYING OPTION A	BLACK	SPS/NYLON GF20
DESCRIPTION	COLOR	MATERIAL

BOM/APPLICABLE COMPONENTS TABLE

ABBREVIATION	COMPONENT
A	HOUSING KEY A
B	HOUSING KEY B
C	HOUSING KEY C
D	HOUSING KEY D
GCO	GROMMET CAP, OPEN
GCP	GROMMET CAP, CLOSED
M	MAT SEAL
R	RING SEAL
P	PLR, STANDARD
CPA	CPA
BKS	BACKSHELL

ENTER DESCRIPTION ELEC NO: UAU2014-1876 DRAWN BY: CHKO APPR: VKOSHY 2014/06/19 2014/06/19 C11	QUALITY SYMBOLS ∇=0 ∇=0 ∇=0	GENERAL TOLERANCES (UNLESS SPECIFIED) 4 PLACES ± .000 ± .000 3 PLACES ± .000 ± .000 2 PLACES ± 0.10 ± .000 1 PLACE ± 0.2 ± .000 0 PLACE ± .000 ± .000	DIMENSION STYLE MM ONLY	SCALE DESIGN UNITS METRIC	THIRD ANGLE PROJECTION
	DRAWN BY: SVERZYL DATE: 06/17/08 CHECKED BY: DGRIFITHS DATE: 06/18/08 APPROVED BY: VKOSHY DATE: 2010/11/04		TITLE MX150 1X2 RECEPTACLE SEALED ASSEMBLY MAT SEAL		
	MATERIAL NO. SEE BOM		DOCUMENT NO. SD-33471-021		
	DRAFT WHERE APPLICABLE MUST REMAIN WITHIN DIMENSIONS		SHEET NO. 7 OF 7		

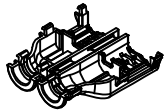

1X2 RECEPTACLE

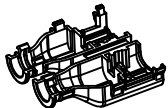
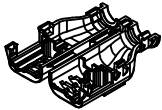

1X3 RECEPTACLE

TABLE OF CONTENTS	
SHEET NO.	SHEET DESCRIPTION
1	NOTES AND BOM
2	CONFIGURATIONS
3	BACKSHELL DETAIL

BILL OF MATERIALS (BOM)				
PART NUMBER	CIRCUIT SIZE	RIBS	STATUS	MATING ASSEMBLY DRAWING
34949-0210	1X2	YES	SALEABLE	SD-33471-021
34949-0220	1X2	NO	SALEABLE	SD-33471-021
34949-0310	1X3	YES	SALEABLE	SD-33471-031
34949-0320	1X3	NO	NOT TOOLED	SD-33471-031

BACKSHELL NOTES: VALID UNLESS OTHERWISE SPECIFIED

1. GENERAL:
 - a. APPLICATION SPECIFICATION SEE: AS-34951-001
 - DESIGNED TO MATE WITH RECEPTACLE SEALED ASSEMBLY AS SPECIFIED IN BOM
 - COMPONENTS ARE OPTIONAL AND MUST BE PURCHASED SEPERATELY
 - BACKSHELL DESIGN IS OWNED BY SCHLEMMER
 - b. PRODUCT SPECIFICATION
 - THESE PRODUCTS ARE ONE TIME USE ONLY.
 - REMOVAL FORCE OF THE BACKSHELL FROM THE MOLEX CONNECTOR TO BE 100N MIN.
 - REMOVAL FORCE OF SLIT CONVOLUTE FROM THE WITH RIB OPTION BACKSHELLS TO BE 100N MIN.
 - REMOVAL FORCE OF UNSLIT CONVOLUTE FROM THE WITH RIB OPTION BACKSHELLS TO BE 100N MIN.
 - c. PACKAGING SPECIFICATION SEE PK-31302-118
 - d. PARTS MUST BE IN COMPLIANCE TO MOLEX CHEMICAL SUBSTANCES FOR PRODUCTS AND PACKAGING SPECIFICATION: QEHS-699000-300
 - e. DATA MUST BE SUBMITTED UNDER THE MOLEX PART NUMBER TO IMDS (COMPANY ID#13255)
 - f. FOLLOWING PRODUCTION CODES TO BE PRESENT
 - DATE CODE
 - MOLD CAVITY CODE
 - MOLEX LOGO
 - RECYCLE CODE
 - SUPPLIER PART NUMBER
2. DESIGN - MATERIALS:
 - a. PA66 0% GLASS FILLED
 - b. BLACK
3. DESIGN GEOMETRY:
 - a. THIS IS A 100% CAD GENERATED PART. THE CAD MATHEMATICAL DATA IS THE MASTER FOR THIS PART. FOR DIMENSIONAL OR ANY INFORMATION NOT SHOWN ON THIS DRAWING, ANALYZE THE CAD MODEL.
 - b. GEOMETRIC DIMENSIONS AND TOLERANCES PER ASME Y14.5M - 2009
 - c. CORNERS SHOWN AS SHARP TO BE R 0.1.
 - d. VISUAL DEFECTS SHALL MEET COSMETIC STANDARD PS-45499-002 (CLASS B).
 - e. DRAFT OF 2° PRESENT.
 - f. ALLOWABLE FLASH, PARTING LINES MISMATCH, EJECTOR PINS MARK, AND GATE VESTIGE TO BE +0.30 MAX PROTUSION.

A4	UPDATED BOM TABLE
A3	CHANGE THE 34949-0310 STATUS TO "SALEABLE"
A2	ADD 1X3 CIRCUIT SIZE
A1	UPDATED STATUS COLUMN
A	INITIAL RELEASE

ENTER DESCRIPTION IEC NO: UAU2015-1693 DRAWN: KBORUSZSKI 2015/05/11 CHKD: APPR: VKOSHY 2015/05/12	QUALITY SYMBOLS	GENERAL TOLERANCES (UNLESS SPECIFIED)	DIMENSION STYLE	SCALE	DESIGN UNITS	THIRD ANGLE PROJECTION
	▽=0	mm INCH	MM ONLY	1:1	METRIC	☉
	▽=0	4 PLACES ± --- ± ---	DRAWN BY DATE	TITLE		
	▽=0	3 PLACES ± --- ± ---	KCUNNINGHAM 2013/06/10	MX150 RECEPTACLE SINGLE ROW BACKSHELL		
	2 PLACES ± 0.13 ± ---	CHECKED BY DATE	DOCUMENT NO.			SHEET NO.
	1 PLACE ± 0.25 ± ---	XBTANG 2014/05/14	SD-34949-0001			1 OF 3
	0 PLACE ± --- ± ---	APPROVED BY DATE	MATERIAL NO.			
	ANGULAR ± 1 °	VKOSHY 2013/06/11	SEE BOM			
	DRAFT WHERE APPLICABLE MUST REMAIN WITHIN DIMENSIONS		SIZE			
			THIS DRAWING CONTAINS INFORMATION THAT IS PROPRIETARY TO MOLEX INCORPORATED AND SHOULD NOT BE USED WITHOUT WRITTEN PERMISSION			

20 19 18 17 16 15 14 13 12 11 10 9 8 7 6 5 4 3 2 1

CONFIGURATION

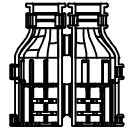

34949-0210
1X2 FEMALE WITH RIBS

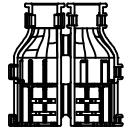

34949-0220
1X2 FEMALE WITHOUT RIBS



34949-0310
1X3 FEMALE WITH RIBS



34949-0320
1X3 FEMALE WITHOUT RIBS

ENTER DESCRIPTION IEC NO: UAU2015-1693 DRAWN BY: BORUSZENSKI, 2015/05/11 CHKD: CHYK APPR: VKOSHY, 2015/05/12 REV:	QUALITY SYMBOLS ▽=0 ▽=0 ▽=0	GENERAL TOLERANCES (UNLESS SPECIFIED) <table border="1"> <thead> <tr> <th></th> <th>mm</th> <th>INCH</th> </tr> </thead> <tbody> <tr> <td>4 PLACES</td> <td>± 0.13</td> <td>± 0.005</td> </tr> <tr> <td>3 PLACES</td> <td>± 0.25</td> <td>± 0.010</td> </tr> <tr> <td>2 PLACES</td> <td>± 0.38</td> <td>± 0.015</td> </tr> <tr> <td>1 PLACE</td> <td>± 0.51</td> <td>± 0.020</td> </tr> <tr> <td>0 PLACE</td> <td>± 0.64</td> <td>± 0.025</td> </tr> </tbody> </table> ANGULAR ± 1 ° DRAFT WHERE APPLICABLE MUST REMAIN WITHIN DIMENSIONS		mm	INCH	4 PLACES	± 0.13	± 0.005	3 PLACES	± 0.25	± 0.010	2 PLACES	± 0.38	± 0.015	1 PLACE	± 0.51	± 0.020	0 PLACE	± 0.64	± 0.025	DIMENSION STYLE MM ONLY	SCALE 1:1	DESIGN UNITS METRIC	THIRD ANGLE PROJECTION
		mm	INCH																					
	4 PLACES	± 0.13	± 0.005																					
	3 PLACES	± 0.25	± 0.010																					
2 PLACES	± 0.38	± 0.015																						
1 PLACE	± 0.51	± 0.020																						
0 PLACE	± 0.64	± 0.025																						
DRAWN BY: KCUNNINGHAM CHECKED BY: XBTANG APPROVED BY: VKOSHY	DATE: 2013/06/10 DATE: 2014/05/14 DATE: 2013/06/11	TITLE MX150 RECEPTACLE SINGLE ROW BACKSHELL	MATERIAL NO. SEE BOM	DOCUMENT NO. SD-34949-0001	SHEET NO. 2 OF 3																			
THIS DRAWING CONTAINS INFORMATION THAT IS PROPRIETARY TO MOLEX INCORPORATED AND SHOULD NOT BE USED WITHOUT WRITTEN PERMISSION																								
SIZE D																								

19 18 17 16 15 14 13 12 11 10 9 8 7 6 5 4 3 2 1

BACKSHELL DETAIL

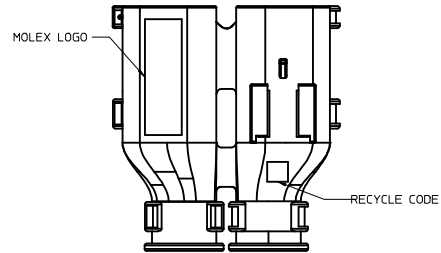
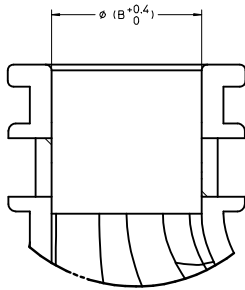
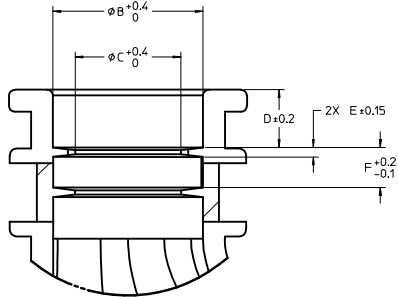
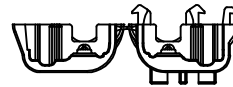
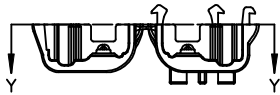
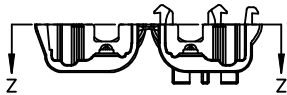
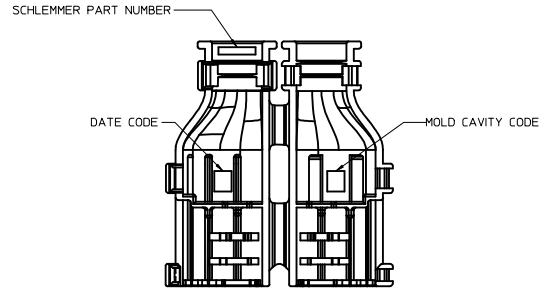
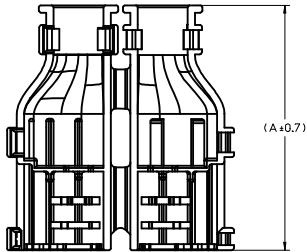
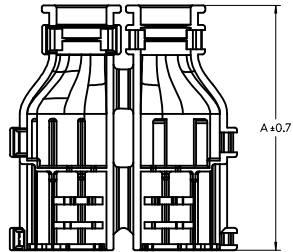

Partial Z-Z
SCALE 6:1
WITH RIBS

Partial Y-Y
SCALE 6:1
WITHOUT RIBS

PART NUMBER	DIMENSIONS					
	A	B	C	D	E	F
34949-0210	50	10.2	7.2	3.9	0.65	2.7
34949-0220	50	10.2	N/A	N/A	N/A	N/A
34949-0310	50	10.2	7.2	3.9	0.65	2.7
34949-0320	50	10.2	N/A	N/A	N/A	N/A

ENTER DESCRIPTION IEC NO. UAU2015-1693 DRAWN BY: BORUSZENSKI, 2015/05/11 CHKD: CHYK APPR: VKOSHY, 2015/05/12	QUALITY SYMBOLS	GENERAL TOLERANCES (UNLESS SPECIFIED)	DIMENSION STYLE	SCALE	DESIGN UNITS	THIRD ANGLE PROJECTION
	$\nabla=0$ $\nabla=0$ $\nabla=0$	mm INCH 4 PLACES ± --- ± --- 3 PLACES ± --- ± --- 2 PLACES ± 0.13 ± --- 1 PLACE ± 0.25 ± --- 0 PLACE ± --- ± ---	MM ONLY	2:1	METRIC	
	DRAFT WHERE APPLICABLE MUST REMAIN WITHIN DIMENSIONS	ANGULAR ± 1° MATERIAL NO. SEE BOM	DRAWN BY DATE KCUNNINGHAM 2013/06/10 CHECKED BY DATE XBANG 2014/05/14 APPROVED BY DATE VKOSHY 2013/06/11	TITLE MX150 RECEPTACLE SINGLE ROW BACKSHELL molex	DOCUMENT NO. SD-34949-0001	SHEET NO. 3 OF 3
	THIS DRAWING CONTAINS INFORMATION THAT IS PROPRIETARY TO MOLEX INCORPORATED AND SHOULD NOT BE USED WITHOUT WRITTEN PERMISSION					