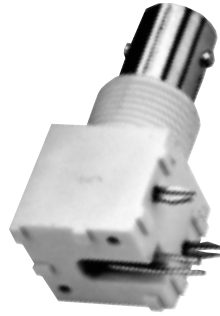
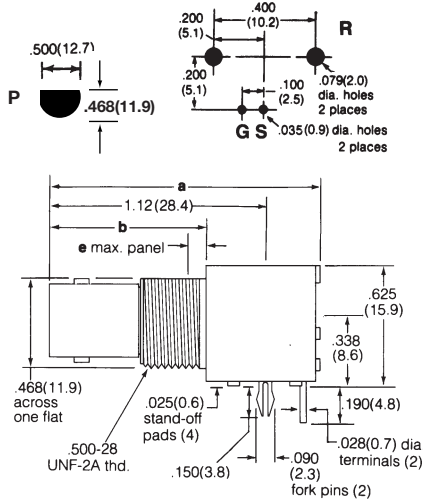

Fig. 1

Standard Height 50 ohm BNC Printed Circuit Board Right Angle Bulkhead Receptacles ☆



Isolated from Panel
White Valox Housing
31-5431▲ (Round Pins)
31-5431-1010 (Fork Pins)
31-5431-10RFX



Isolated from Panel
Black Valox Housing
31-5538 (Round Pins)
31-5538-1010 (Fork Pins)
31-5538-10RFX

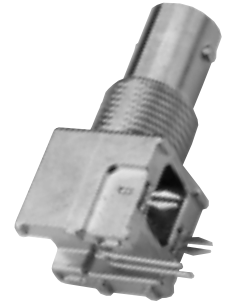

Metal Housing
31-5640▲ (Round Pins)
31-5640-1010 (Fork Pins)

Fig. 2

Low Profile 50 ohm BNC Printed Circuit Board Bulkhead Receptacles ☆

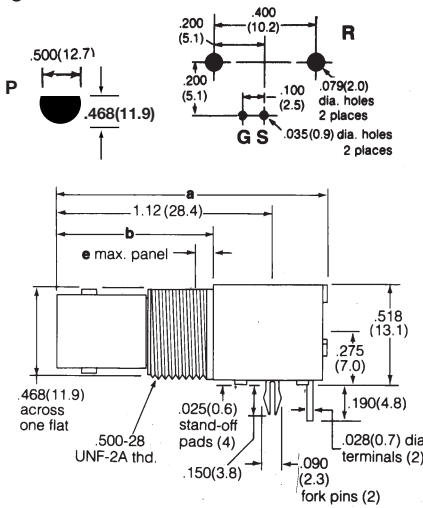

Isolated from Panel
White Valox Housing
31-5486▲ (Round Pins)
31-5486-1010 (Fork Pins)
31-5486-10RFX



Isolated from Panel
Black Valox Housing
31-5540 (Round Pins)
31-5540-1010 (Fork Pins)
31-5540-10RFX



Metal Housing
31-5637 (Round Pins)

Fig. 3

Vertical 50 ohm BNC Printed Circuit Board Bulkhead Receptacles ☆

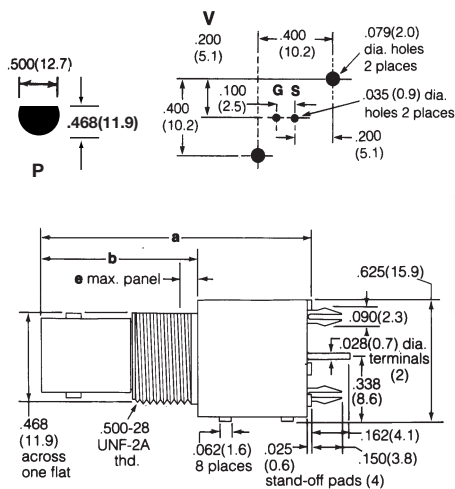

Isolated from Panel
White Valox Housing
31-5493▲ (Round Pins)
31-5493-1010 (Fork Pins)







Isolated from Panel
Black Valox Housing
31-5539 (Round Pins)
31-5539-1010▲ (Fork Pins)
31-5539-10RFX

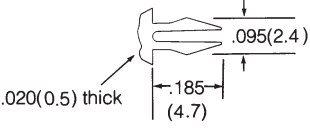

Metal Housing
31-5633 (Round Pins)
31-5633-1010 (Fork Pins)

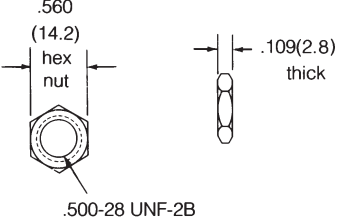
▲ distributor stocked ☆ Jam nuts and lockwashers sold separately.

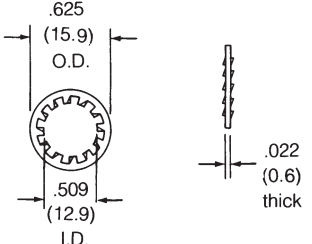
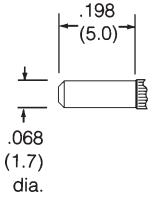
 <p>Fork Pin holds connectors rigidly to P.C. Board for high temperature and mass production assembly</p>	<p>Fig. 4</p>   <p>Pkg. of 100, Hex Nut for BNC Bulkhead PCB Receptacles 31-5652▲ Nickel Plated</p>	<p>Fig. 5</p>   <p>Pkg. of 100, Lockwasher for BNC PCB Bulkhead Receptacles 31-5653▲ Nickel Plated</p>
 <p>Round Pin (Standard)</p>		

BNC PRINTED CIRCUIT BOARD BULKHEAD RECEPTACLES AND ACCESSORIES

Description	Terminal Type	Dimensions, inches (millimeters)			Notes		Mtg. Hole	Notes	MTG. Pin Type	Imp	Amphenol Number	Fig.
		a	b	e	Pit.	Ins.						
Standard Height Printed Circuit Angle Bulkhead Receptacle (J)☆	Blunt Posts for Signal & Ground	1.40(35.6)	.810(20.6)	.250(6.4)	P26	D17	R/P	Iso. White Housing	Round	50Ω	31-5431	1
					P26	D17	Fork		50Ω	31-5431-1010		
					P26	D20	R/P	Iso. Black Housing	Round	50Ω	31-5538	1
					P26	D20	Stamp		50Ω	31-5538-10RFX		
					P26	D22	R/P	Metal Housing	Round	50Ω	31-5640	1
					P26	D22	Fork		50Ω	31-5640-1010		
					P25	D17	R/P	Iso. White Housing	Fork	50Ω	31-5431-10RFX	
Low Profile Printed Circuit Angle Bulkhead Receptacle (J)☆	Blunt Posts for Signal & Ground	1.40(35.6)	.810(20.6)	.250(6.4)	P26	D17	R/P	Iso. White Housing	Round	50Ω	31-5486	2
					P26	D17	Fork		50Ω	31-5486-1010		
					P26	D20	R/P	Iso. Black Housing	Round	50Ω	31-5540	2
					P26	D20	Fork		50Ω	31-5540-1010		
					P26	D22	R/P	Metal Housing	Round	50Ω	31-5637	2
P26	D22	Fork	50Ω	31-5637-1010								
Vertical Printed Circuit Bulkhead Receptacle (J)☆	Blunt Posts for Signal & Ground	1.40(35.6)	.810(20.6)	.250(6.4)	P26	D17	V/P	Iso. White Housing	Round	50Ω	31-5493	3
					P26	D17			Fork	50Ω	31-5493-1010	
					P26	D20	V/P	Iso. Black Housing	Round	50Ω	31-5539	3
					P26	D20			Fork	50Ω	31-5539-1010	
					P26	D22	V/P	Metal Housing	Round	50Ω	31-5633	3
					P26	D22			Fork	50Ω	31-5633-1010	
					P25	D13	R/P	Iso. White Housing	Fork	50Ω	31-5486-10RFX	2
					P25	D20	R/P	Iso. Black Housing	Fork	50Ω	31-5540-10RFX	2
Hex Nut for BNC Bulkhead PCB Receptacles, Package of 100 ea.					P3	—	—	Nickel Plated	—	—	31-5652	4
Lockwasher for BNC Bulkhead PCB Receptacles, Package of 100 ea.					P3	—	—	Nickel Plated	—	—	31-5653	5

☆ Jam nuts and lockwashers sold separately. See Figs. 4 & 5 ▲ distributor stocked