

Description	Material	Finish
Body	Brass	Nickel
Socket	Brass	Gold
Insulation	PTFE	N/A
O-Ring	Si Rubber	Rubber
Crimp ring	Brass	Nickel
Washer	Brass	Nickel
Nut	Brass	Nickel
Heat Shrink	Polyolefin	Black

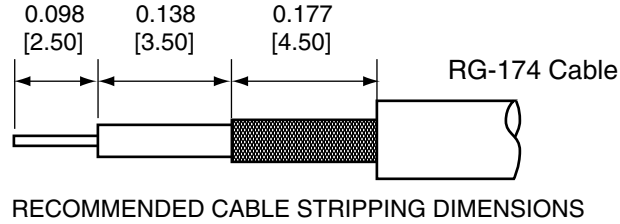

REVISIONS			
REV	DESCRIPTION	DATE	APPV
B	Updated dimensions; Added new title block	10-JUL-12	SAH
C	Updated socket look and dim.; Updated crimp ring dim.	29-OCT-12	SAH

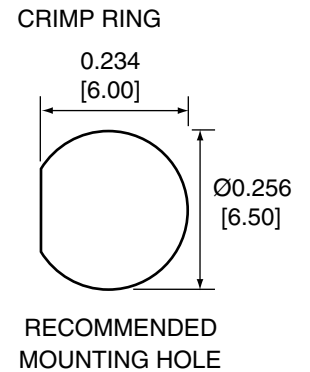
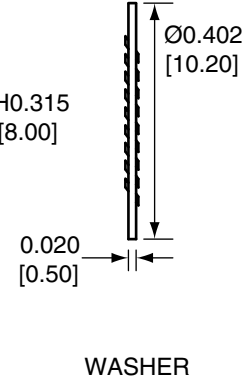
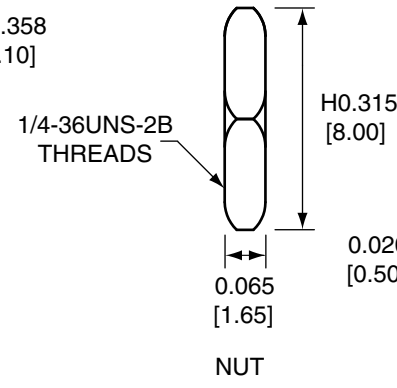
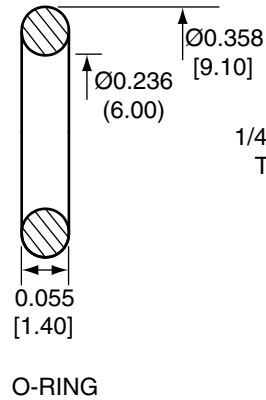
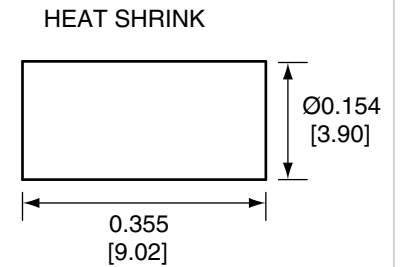
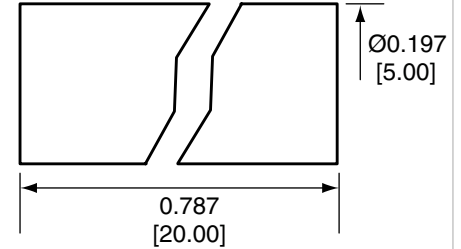
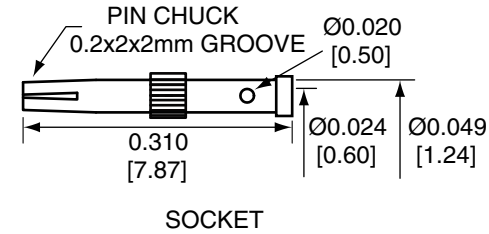
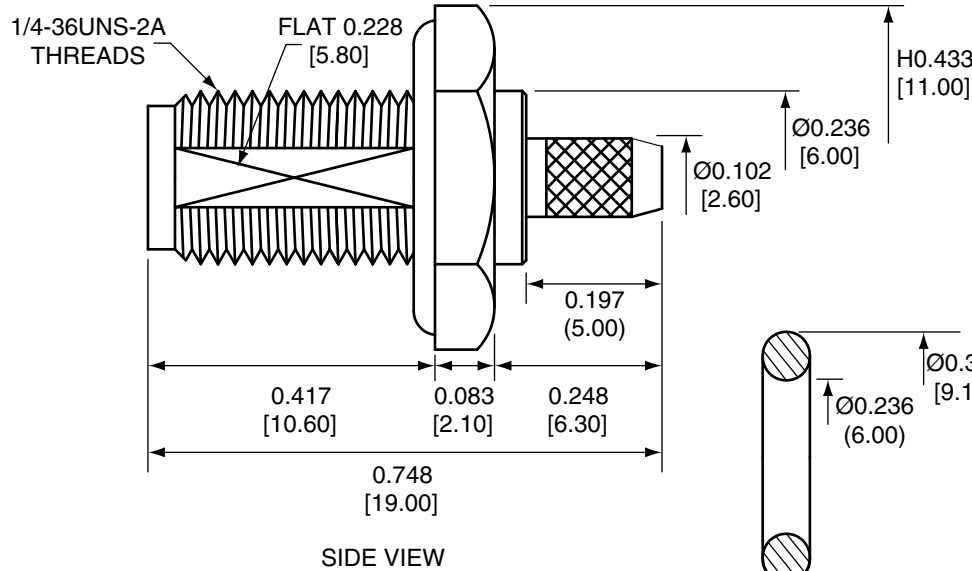

NOTES: (UNLESS OTHERWISE SPECIFIED)

- ALL DIMENSIONS ARE IN INCHES [mm].
- DIMENSIONS APPLY AFTER FINISHING.
- MANUFACTURE TO BE COMPLIANT WITH EU RoHS DIRECTIVE.
- SAFETY BREAK ALL SHARP CORNERS AND EDGES .02 MAXIMUM.

#### CONSMSA014 ASSEMBLY INSTRUCTIONS

- Strip the cable to recommended dimensions.
- Slip heat shrink and crimp ring onto stripped cable.
- Insert o-ring into groove in the nut on body.
- Solder the socket to the center conductor.
- Insert the socket, center conductor, and insulation into the body.
- Wrap the braid around the tail of the body and crimp the ring with 0.128" hex crimp tool (or one labeled for use with RG-174 cable).
- Use heat shrink to cover crimp.
- Use the nut and washer to secure the connector to a case. (2.50mm maximum wall thickness)

WARNING: THIS DRAWING CONTAINS PROPRIETARY INFORMATION THAT IS THE SOLE PROPERTY OF LINX TECHNOLOGIES, AND SHALL BE TREATED AS SUCH. NO DISCLOSURE OR REPRODUCTION OF THIS DOCUMENT IS PERMITTED, IN WHOLE OR IN PART, WITHOUT THE EXPRESS WRITTEN PERMISSION OF LINX TECHNOLOGIES OR ITS DESIGNATED AGENTS.

MATERIAL:	TOLERANCES: .020 [0.50]-.200 [5.00]= ±.008 [0.20] .200 [5.00]-1.200 [30.00]= ±.016 [0.40] 1.20 [30.0]-4.75 [120.0]= ±.024 [0.60] 4.75 [120.0]-12.40 [315.0]= ±.040 [1.0]	PROJECTION: 
FINISH:	DRAWN: B.MURPHY DT: 10-JUL-12	ANGLES: ±1°
	ENGR: S.HOGAN DT: 10-JUL-12	

<b>Linx</b>		159 ORT LANE MERLIN, OR 97532	
TITLE: SMA FEMALE BULKHEAD MOUNT CABLE END CRIMP WITH O-RING FOR RG174 CABLE			
SIZE <b>A</b>	DWG. NO. CONSMSA014	REV <b>C</b>	
SCALE: 2:1	DO NOT SCALE DRAWING	SHEET 1 OF 1	