

SPECIFICATIONS

RoHS



Model Number: MX2B3
Part Number: 19028422A

Version: 00
Sep 23, 2016

Mechanical Drawing:

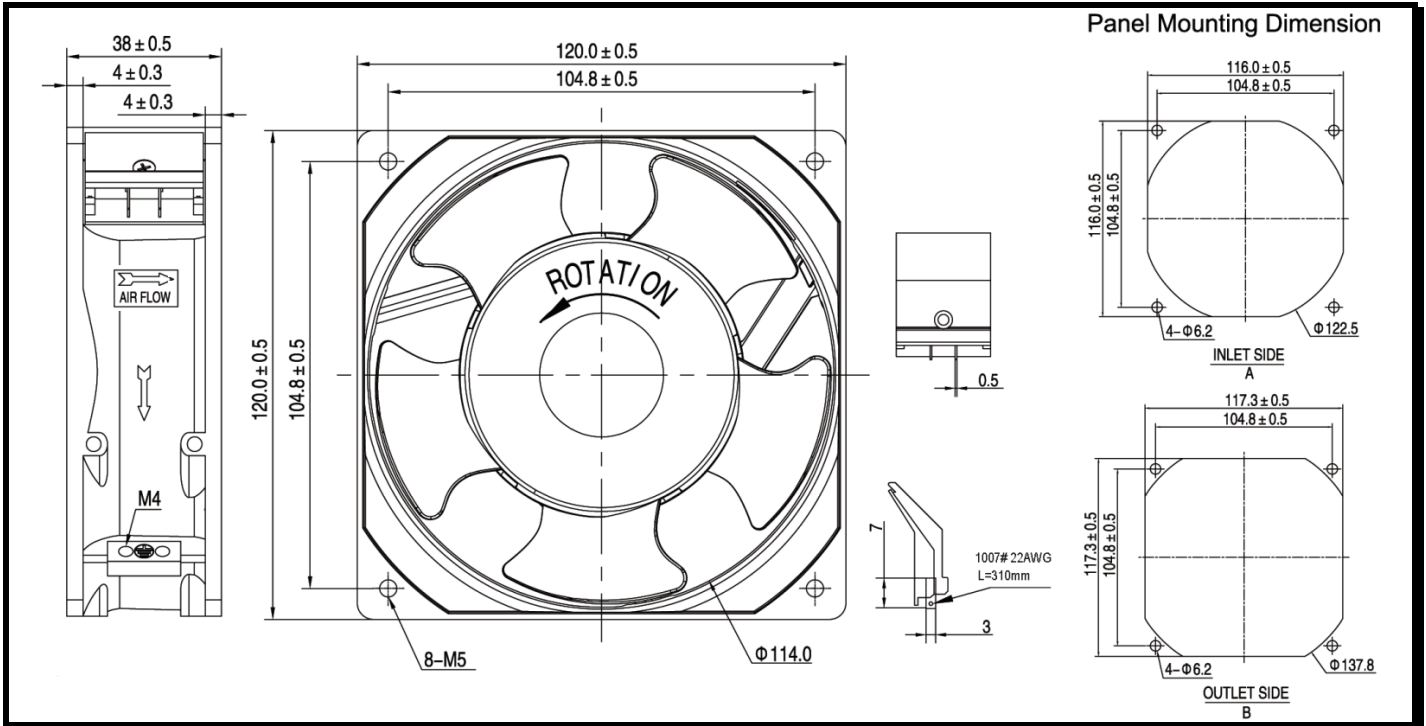

Motor:

Start Voltage	= 83VAC
Rated Voltage	= 110 VAC $\pm 10\%$
Operating Voltage Range	= 103~126VAC
Operating Frequency	= 60Hz
Rated Current	= 0.26A
Input Power	= 20Watt
Rated Speed	= 2850RPM $\pm 10\%$
Bearings	= Ball
Airflow	= 100CFM
(Measuring at zero static pressure)	
Static Pressure	= 0.25" H ₂ O
(Measuring at zero air flow)	
Noise Level	= 52 dB(A)
Net Weight	= 460 gram.
(Measuring at 25°C, RH 65% for Above Items)	

Construction:

Venturi: High quality magnesium alloy die-casting Frame with ED coating and powder coating, Black.
 Propeller: PBT +30%GF.

Life Expectancy:

This fan is designed for continuous duty life of 60,000 hours at 20°C; 50,000 hours at 40°C; 40,000 hours at 60°C; 20,000 hours at 90°C.

Additional Features:

Insulation Resistance: 100M Ω or more at 500 V megger.
 Dielectric strength: 2 seconds at 1800 VAC/ 50-60 Hz.
 Thermal Shock: Test per MIL-STD-202F, method 107G, condition D.
 Operating Temperature: -00°C to 70°C
 Storage Temperature: -10°C to 50°C
 Humidity RH: 20% ~ 85% (Max.)
 Ingress of protection: IP55/Mg Impeller

Termination:

See Mechanical Drawing.
 Joint terminal suit with 22AWG 1007# Wire
 PV1.25-3A-0.5 terminal (TAIWAN UTA Co.)

Agency Approvals:

UL, CUL, CE