

THIS COPY IS PROVIDED ON A RESTRICTED BASIS AND IS NOT TO BE USED IN ANY WAY DETRIMENTAL TO THE INTERESTS OF PANDUIT CORP.

Material	High Conductivity Seamless Copper Tube
Plating	Electro-Tin
Wire Size	400 kcmil
Wire Type	Stranded Copper; Class B: Compact, Compressed or Concentric, Class C: Concentric
Wire Strip Length	2-3/8 in.
Stud Size	7/8 in.
UL Listed Wire Connector	Yes, for applications up to 35kv. Consult cable manufacturer for voltage stress relief instructions with applications greater than 2000 volts.
UL Temperature Rating	90° C
C.S.A Certified Wire Connector	Yes
Panduit Color Code on Barrel	BLUE
Panduit Die Index No. on Barrel	P76
Alternate Industry Die Index No. () on Barrel	(19)

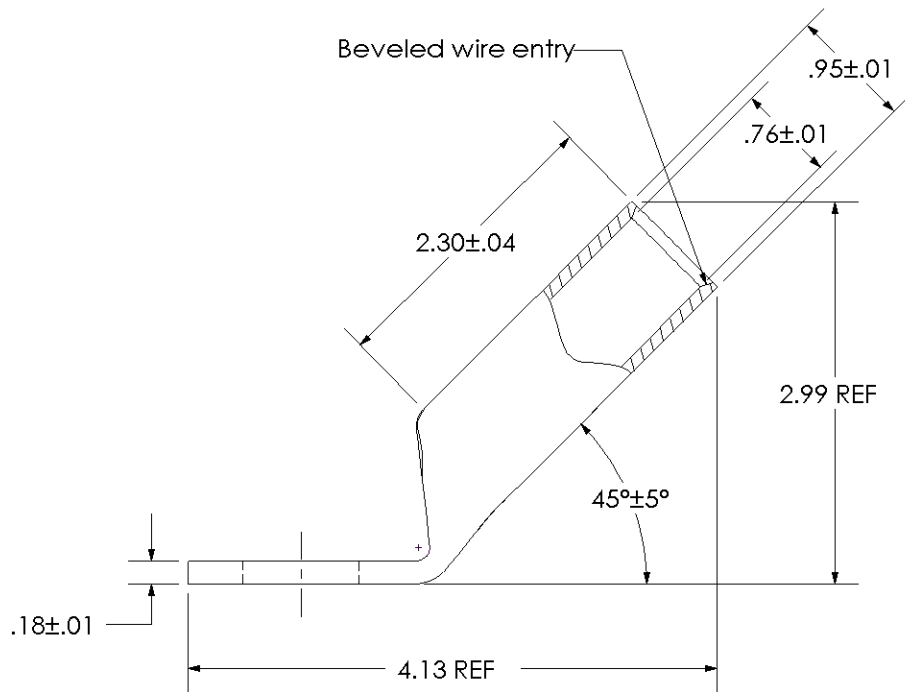
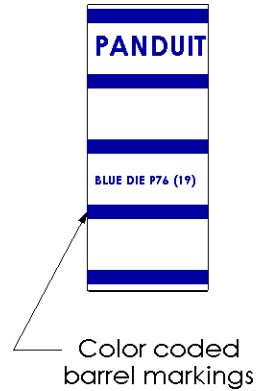
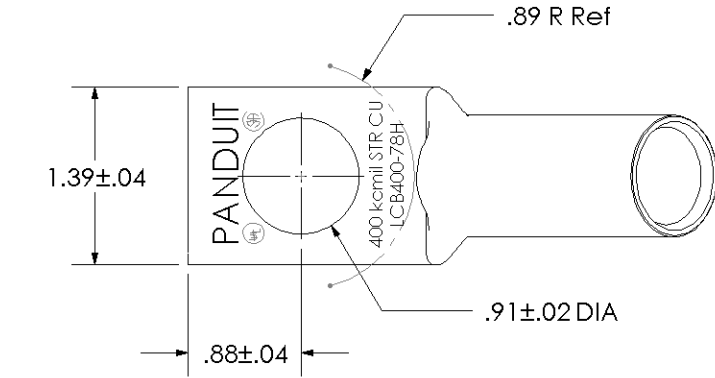

00	12/02	SAB	DRL
REV	DATE	BY	CHK

RELEASED	DESCRIPTION
----------	-------------

10328	SCALE	N/A	DRAWING NO / CAD FILE	LCB400-78H-CUST
PANDUIT CORP. TINLEY PARK, ILLINOIS		LCB400-78H-6 Copper Lug - One-Hole, Long Barrel, 45° Angle Tongue		